

# **ACIQ WIRED REMOTE CONTROLLER**

---

## **Installation and Owner's Manual**

### **MODEL:**

KJR-120N(X4)/BGEF

KJR-120N(X4W)/BGEF

KJR-120N(X5)/BGEF

KJR-120N(X5W)/BGEF

KJR-120N(X6)/BGEF

KJR-120N(X6W)/BGEF

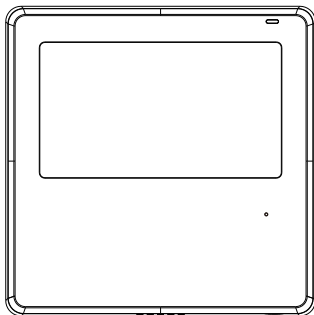

### **IMPORTANT NOTE:**

Please read this manual carefully before installing or operating your wired remote controller. Make sure to save this manual for future reference.

**This manual describes the installation procedure and owner operations of the KJR-120N series thermostat.**

**Please read this manual carefully before installing and using the unit and keep a copy for future reference.**

**All the pictures in this manual are for explanation purposes only. There may be slight differences due to future improvements. Contact ACiQ if you are unable to use the thermostat as described here.**

# Table of Contents

1. Safety precautions	1
2. Installation accessories	2
3. Installation	4
4. Specifications	12
5. Features and functions	13
6. Display Definitions	14
7. Buton Definitions	15
8. Setup	16
9. Operation	17
10. Timer functions	27
11. Weekly Timer 1	30
12. Weekly Timer 2	36
13. Troubleshooting	43
14. Compliance Statement	43
15. Function settings	44
16. WiFicontrol connection	49

## 1. Safety precautions



### WARNING

- Be sure to have this equipment professionally installed.
- Installation by non-professionals may lead to improper performance, electric shock or fire.
- Follow this installation manual carefully.
- Service or repair should be performed by professionals.

Disposal must comply with local regulations.

### NOTE

- Do not install this unit in areas where flammable gasses are present.
- Do not operate with wet hands and keep water away from the thermostat. Electric shock could occur. Observe electric current requirements and be sure to use the
- proper outlets and circuit breakers.

## 1. Safety precautions

### NOTE

- Use correct wire gauge. Do not over tighten terminal screws. If the wire is cut due to over-tightening, restrip wire and start again to avoid overheating at the connection.

## 2. Installation Accessories

### Checklist

1. Please confirm that all the following parts were included.

No.	Name	Qty.	Remarks
1	Wire controller	1	certain models only
2	Installation and owner's manual	1	
3	Screws	3	M3.9*25 (For Mounting on the Wall)
4	Wall plugs	3	For Mounting on the Wall
5	Screws	2	M4X25 (For Mounting on switch box)
6	Plastic screw anchors	2	For fixing on switch box
7	Battery	1	
8	Wiring harness	1	Optional
9	Screw	1	M4X8(For Mounting the connective wire group)

## 2. Installation accessory

### 2. Checklist.

No.	Name	Qty.(embeded into wall)	Specification (only for reference)	Remarks
1	Thermostat base	1	_____	_____
2	Wire harness	1	_____	_____

### Thermostat wiring

1. Please refer to the wiring diagram of this installation manual to connect the wire controller with indoor unit.
2. The wired controller works in low voltage loop circuit. Do not connect this unit to 24v, or high voltage (115V,220V). Improper voltage will burn out thermostat circuitry.
3. Thermostat wiring should be 16" away from high voltage wiring to avoid electrical interference.
4. The Shielded wire of the wired controller must be grounded.

### 3. Installation

#### 1. Wired remote controller structural dimensions

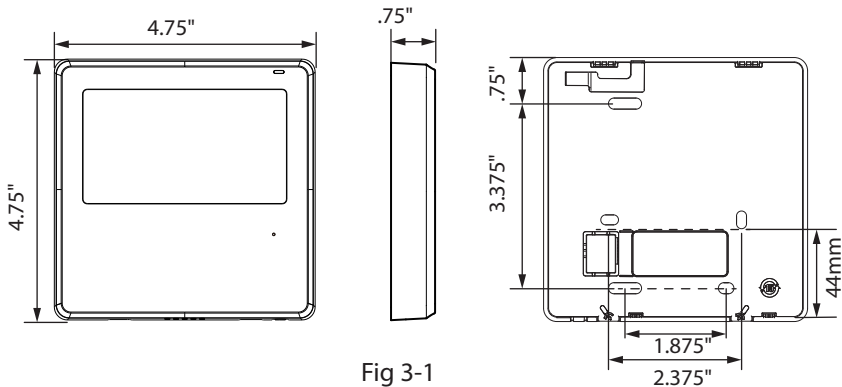

#### 2. Remove the case from the thermostat

- Insert a flat blade screwdriver into the slots in the lower part of the wired controller (2 places), and twist to release tabs. (Fig.3-2)

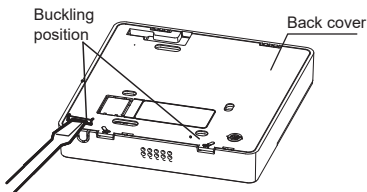

### 3. Installation

**NOTE:** Be careful not to damage the circuit board or other internal components with the screwdriver when opening the case.

#### 3. Fasten the back plate of thermostat

- For wakk mounting, fasten the back plate on the wall with the 3 screws (ST3.9\*25) and anchors. (Fig.3-3)

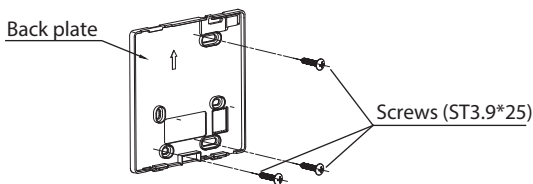

Fig 3-3

- Use included screws to install the back cover on the switch box, and use one screw to attache assembly to the wall.

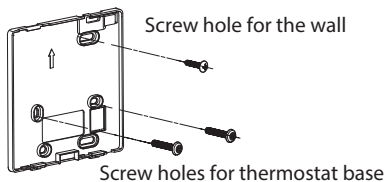

Fig 3-4

### 3. Installation

**NOTE:** Use a flat wall surface for installation location. Be careful not to overtighten the mounting screws.

### 4. Battery installation

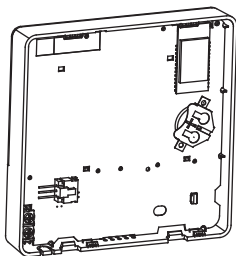

Fig 3-5

- Install the battery making sure the polarity of the battery is in accordance with the +/- indication. (See Fig.3-5)
- The CR2032 battery insures the thermostat will keep time and maintain program settings during a power failure. If the clock is wrong after a power failure, replace the battery.

### 3. Installation

#### 5. Wire to the indoor unit

**A**

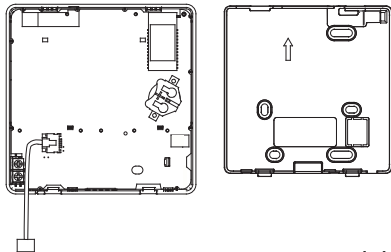

Model A

**B**

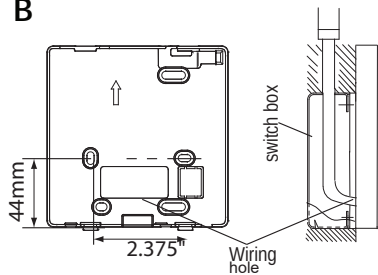

**A**

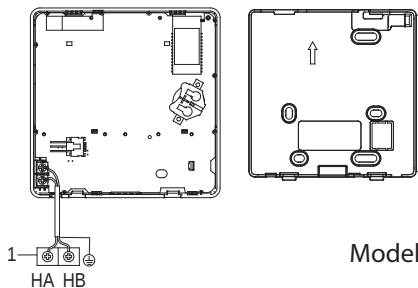

Model B

**B**

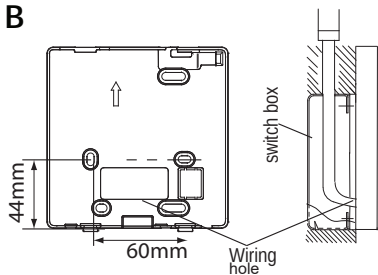
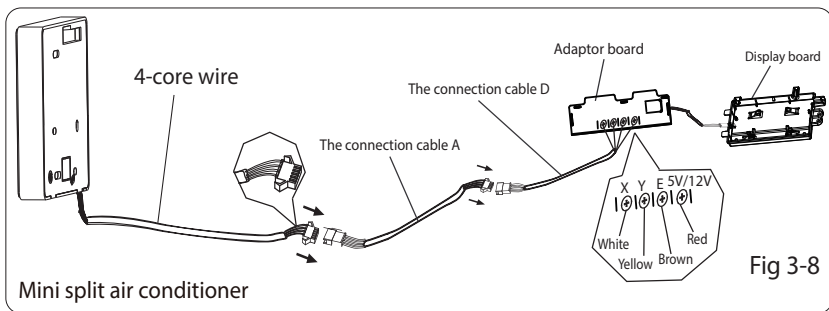
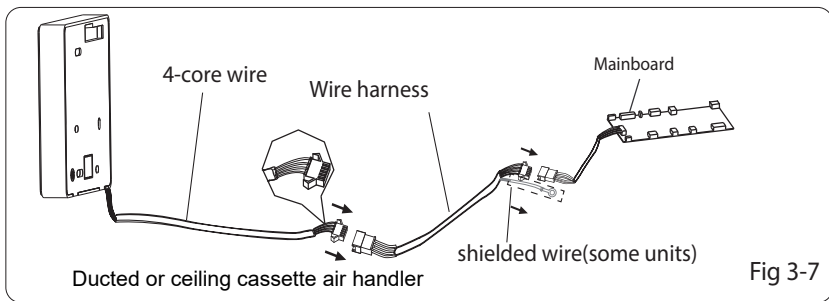

Fig 3-6

### 3. Installation

Model A

Use the included wires to connect the indoor unit to the thermostat as shown. Note there may be unused connections.



### 3. Installation

2-wire model

1 indoor unit

Notch the case for the wiring to pass through with nippers, if needed.

Connect the terminals on the wired controller (HA ,HB), and the terminals of the indoor unit (HA ,HB). (HA and HB do not have polarity.)

#### NOTE:

- Keep water away from thermostat.
- Wires must be firmly connected. Gently pull wires to make sure the connection is secure.

The 2 wire thermostat connects to the air handler HA and HB ports. There is no polarity between HA and HB. See Fig. 3-9

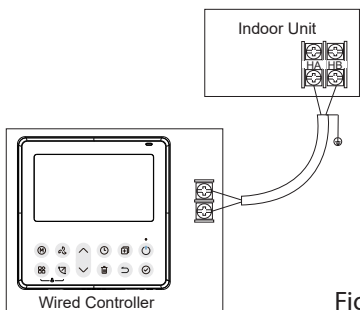

Fig.3-9

### 3. Installation

The main/secondary wired controller can be used to enable two wired controllers to control one unit, and the wired controllers connect to the unit HA and HB ports through the HA and HB port on the controller. There is no polarity between HA and HB. See Fig. 3-10

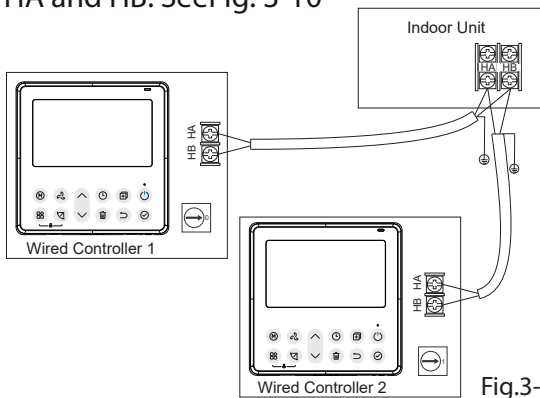

Fig.3-10

**NOTE:** Wire controller with Wireless function does not have this function.

For some units, one wired controller can support multiple units (a maximum of 16 units). In this case, the wired controller and

### 3. Installation

unit need to be connected to the HA and HB ports at the same time. In group control, there will be no error displayed on the wired controller . See Fig. 3-11

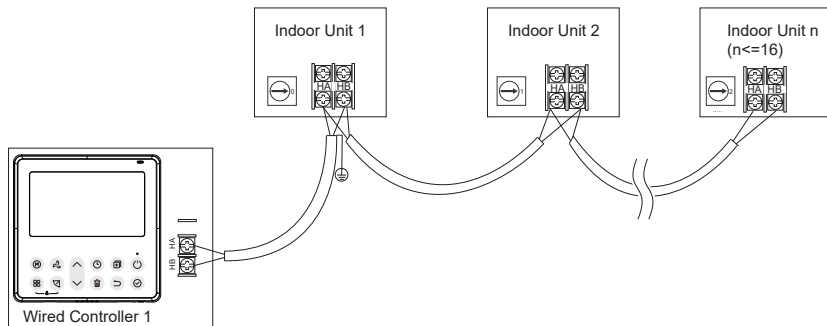

Fig.3-11

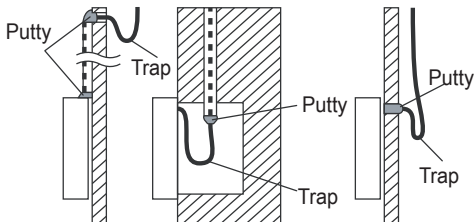

Fig 3-12

## 6. Reattach the thermostat case

- Place the case on the upper mounts, then carefully click into place, being careful not to pinch the wiring. (Fig 3-13)

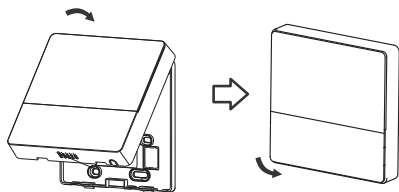

Fig 3-13

All the pictures in this manual are for explanation purpose only. Your thermostat may be slightly different .

## 4. Specifications

Input voltage	12V
Ambient temperature	32~110°F
Ambient humidity	RH40%~RH90%

### Wiring specifications

**NOTE:** If possible, avoid excessive distance for thermostat wiring.  
Under 30' is recommended.

## 5. Thermostat features and functions.

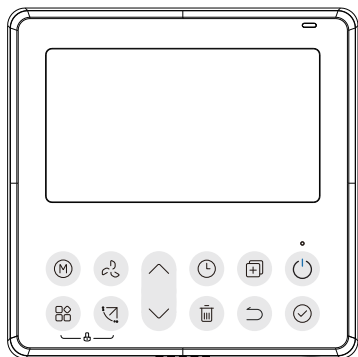

### Features:

- LCD display.
- Error code display: displays the error code for service.
- 4-way wire layout design - gives extra room for wiring for easy installation.
- Room temperature display.
- Weekly Timer.

---

### Functions:

- Mode: Choose Auto-Cool-Dry-Heat-Fan
- Fan speed: Auto/Low/Med/High speed
- Swing(on some models)
- Timer ON/OFF
- Temp setting
- Weekly timer
- Follow me
- Turbo
- 24-hour System
- 12-hour System
- Auto-restart
- Individual louver control (on some models)
- Automatic airflow test
- Rotation&Back-up
- Dual Control
- Group Control
- Child Lock
- LCD display
- Clock

## 6. Display Definitions

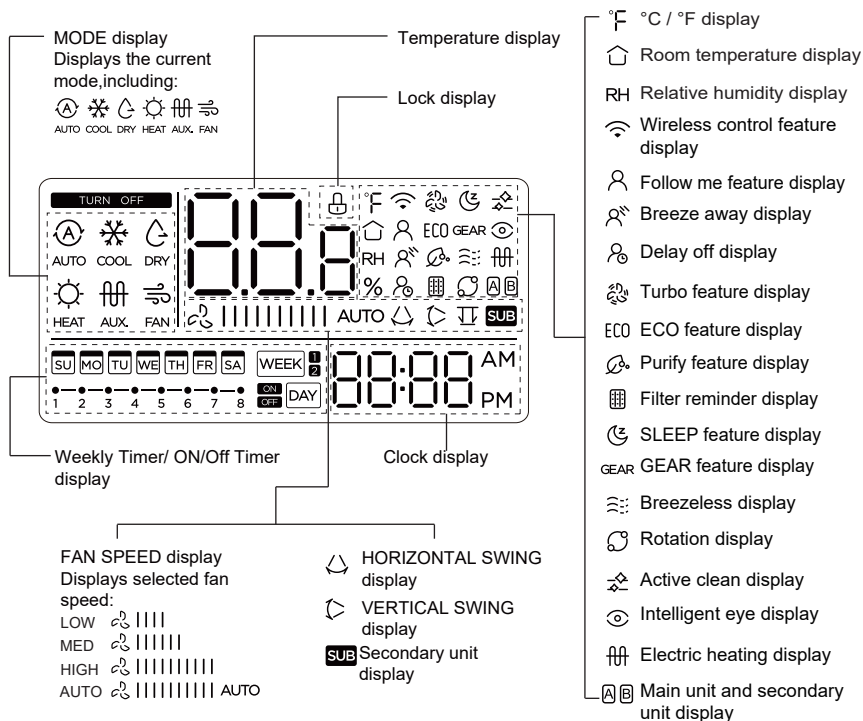

## 7. Button Definitions

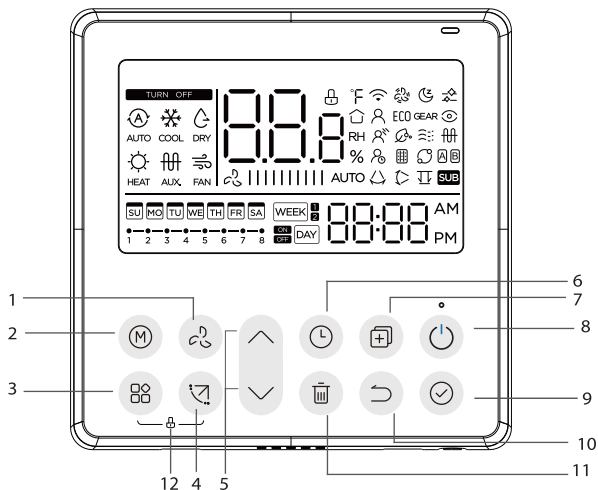

1 FAN SPEED button

2 MODE button

3 FUNC. button

4 SWING button

5 ADJUST button

6 TIMER button

7 COPY button

8 POWER button

9 CONFIRM button

10 BACK button

11 DAY OFF/DELAY button

12 CHILD LOCK button

## 8. Setup

### Set the current day and time



Press the Timer button for 2 seconds or more.  
The timer display will flash.

---

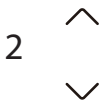

Press the button “^” or “v” to set the date.  
The selected date will flash.



After entering Date, press Timer button or CONFIRM button or wait 10 seconds.

---



Press the button “^” or “v” to set the current time.  
Press repeatedly to adjust the current time in 1-minute increments. Press and hold to adjust the current time continuous.

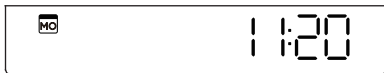

ex. Monday 11:20





The settings are made by pressing CONFIRM button or wait 10 seconds.

6



### Time scale selection

Press the buttons “” and “” for 2 seconds will alternate the clock time display between 12h & 24h scale.

## 9. Operation

### To start/stop operation



Press the Power button.

## 9. Operation

### To set the operation mode

Operation mode setting(Heat mode is invalid for cool only type unit)



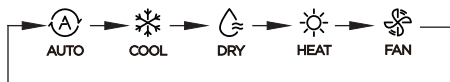

Press this button to select the operation mode:



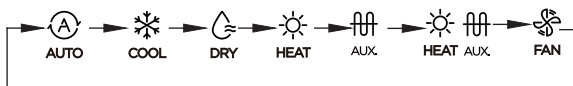

If the indoor unit has Electric heating (Emergency heating) feature, press this button to select the operation mode:





- When the mode is selected as emergency heating (or electric heating) mode,  AUX. is displayed, the fan speed is Auto. The Sleep, 8-degree heating, Turbo, and Rotation functions are not available in emergency heating mode.
- When the mode is selected as heating & electric heating mode,  is displayed, and the Turbo and Rotation functions are disabled.

## 9. Operation

### Room temperature setting

-  Lower Press the button “ ^ ” or “ ∨ ” to set the room temperature. Indoor Setting Temperature Range : (50/60/62~86°F) or (68~82°F).  
 Raise (Model dependent)

 +  °C & °F scale selection (on some models)  
Press the buttons “ ^ ” and “ ∨ ” together for 3 seconds will alternate the temperature display between the °C & °F scale.

### Fan speed setting



Press the Fan speed button to set the fan speed. (This button is unavailable under Auto or Dry mode)

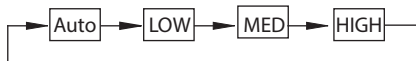

When stepless speed regulation is supported, press the fan speed key to cycle through:

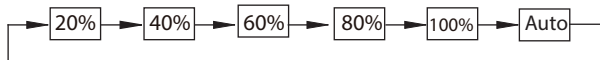



Press the buttons (M) and (fan speed icon) together for 3 seconds to turn on or turn off the keypad tone.

## 9. Operation

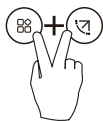
### Child lock function



Press the buttons “” and “” for 3 seconds to activate the child lock function and lock all buttons on the wire controller. You can't press the button to operate or receive remote control signals after the child lock is activated.

Press these two buttons again for 3 seconds to deactivate the child lock function.

When the child lock function is activated, the “” mark appears.

### Swing function(For units with horizontal & vertical swing features only)

#### 1 Up-Down swing



Press the SWING button to start up-down swing function. The “” mark appears. Press it again to stop.

#### 2 Left-Right swing

Press the Swing button for 2 seconds to start Left-Right swing function. The “” mark appears. Press it for 2 seconds again to stop.

## 9. Operation

### Swing function (For units without vertical swing function )



- Use Swing button to adjust the Up-down airflow direction and start the auto swing function.

1. Each time you press this button, the louver swings an angle of 6 degrees. Press this button until the desired direction reaches.

2. If press and hold the button for 2 seconds, the auto swing is activated.



The "  " mark appears. Press it again to stop. (some units)

- For units with four Up-Down louvers, it can be operated individually.



1. Press the Swing button to activate the Up-Down adjusting louver function.

The  mark will flash. (Not applicable to all the models)

2. Pressing the button "  " or "  " can select the movement of four louvers. Each time you push the button, the louver will be selected in a sequence as:

(  means the four louvers move at the same time.)

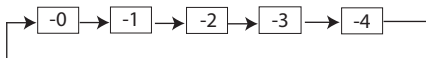



## 9. Operation

Intelligent eye display  (certain models only)

1. This function is valid in any mode of power-on state.
2. If your thermostat has smart eye, press the function key to select the smart eye icon, press the OK key to turn on the smart eye. The smart eye icon will display. Repeat the procedure to toggle Smart Eye off.
3. Shutting down, changing mode, or turning on self-cleaning will automatically cancel the smart eye function.

Filter reset function 

At the appropriate usage time, the filter cleaning prompt icon lights up. To reset after filter change, press the function key to select the filter cleaning prompt icon, and press OK.

## 9. Operation

### Humidity setting function

1. If your model has both temperature and humidity, in dehumidification mode, press the function key to select the RH icon, press the confirm key to enter the humidity control mode, the RH icon flashes, press the up and down keys to adjust the humidity, the setting range is OFF->35%~85%, adjusted with 5% humidity. Exit humidity adjustment state after 5 seconds of inactivity.
2. After entering the humidity control mode, press the up and down keys to adjust the set temperature and display the set temperature for 5 seconds, and then restore the set humidity display.
3. After switching the mode, exit the humidity control mode.

## 9. Operation

GEAR function (certain models)

1. If your model has the GEAR function, in boot cooling mode, press the function key to select the GEAR icon, press the confirm key to enter the GEAR control mode. First the display will show the current GEAR status.

50%->75%->OFF can be selected by the up and down keys within 5 seconds. After 5 seconds, the set temperature will be displayed, press the up and down keys to adjust the set temperature.

Powering off, changing Mode, self clean and certain other maintenance functions will cancel the GEAR function.

When using the follow me function  indicator appears, the room temperature is detected by the thermostat.

Press the button again to cancel the follow me function.

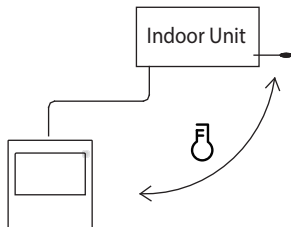

## 9. Operation

This page is intentionally blank.

## 10. Timer functions

WEEK

WEEKLY timer

Use this timer function to set operating times for each day of the week.

ON

DAY

On timer

Use this timer function to start air conditioner operation.

The timer operates and air conditioner operation starts after the time has passed.

OFF

DAY

Off timer

Use this timer function to stop air conditioner operation.

The timer operates and air conditioner operation stops after the time has passed.

ON

OFF

DAY

On and Off timer

Use this timer function to start and stop air conditioner operation.

The timer operates and air conditioner operation starts and stops after the time has passed.

## 10. Timer functions

### To set the On or Off TIMER



Press the Timer button to select the **ON DAY** or **OFF DAY** .

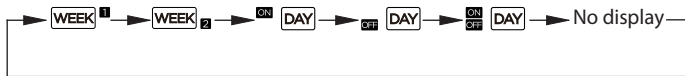

Press the Confirm button and the Timer display is flashing.

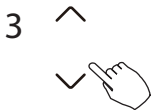

ex. Off timer set at 18:00

Press the button “^” or “v” to set the time.



After the time is set, the timer will start or stop automatically.



Press the Confirm button again to finish the settings.

## 10. Timer functions

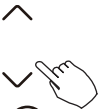

### To set the On and Off TIMER

-  Press the Timer button to select the   .

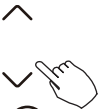

---

-  Press the Confirm button and the Clock display is flashing.

---

-   
  
 Press the button “^” or “v” to set the time of On timer, and then press the Confirm button to confirm the setting.

---

-   
 Press the button “^” or “v” to set the time of Off timer.

---

-  Press the Confirm button to finish the settings.

## 11. Weekly Timer 1

### 1 Weekly timer setting



Press the Timer button to select the **WEEK** and then press the Confirm button to confirm.

### 2 Day of the week setting



Press the button “ $\wedge$ ” or “ $\vee$ ” to select the day of the week and then press the Confirm button to confirm the setting.



### 3 ON timer setting of timer setting 1



Press the button “ $\wedge$ ” or “ $\vee$ ” to set the time of On timer and then press the Confirm button to confirm the setting.

## 11. Weekly Timer 1

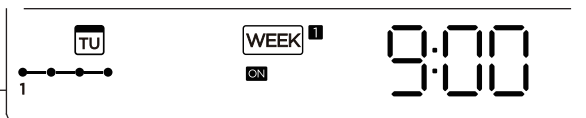

ex. Tuesday time scale 1

Up to 4 timer settings can be saved for each day of the week.

### 4 Off timer setting of timer setting 1



Press the button “^” or “v” to set the time of Off timer and then press the Confirm button to confirm the setting.



ex. Tuesday time scale 1

- Different timer settings can be set by repeating step 3 to 4.
- Other days in one week can be set by repeating step 2 to 5.

**NOTE:** The weekly timer setting can be returned to the previous step by pressing Back button. The timer setting can be deleted by pressing Day off button. The current setting will be restored when there is no operation for 30 seconds.

## 11. Weekly Timer 1

### WEEKLY timer operation

To activate WEEKLY TIMER operation



Press the Timer button while **WEEK** is displayed on the LCD.

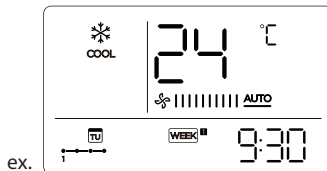

To deactivate WEEKLY TIMER operation



Press the Timer button again **WEEK** will disappear from the LCD.

### To turn off the air conditioner during the weekly timer



1. Press the Power button once to turn the air conditioner off temporarily. The air conditioner will turn on automatically at the next On timer.

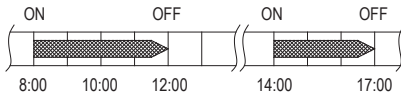

ex. If press the POWER button once at 10:00, the air conditioner will turn on at 14:00.

2. Press the Power button for 2 seconds, the air conditioner will turn off completely, and cancel the timer function.

## 11. Weekly Timer 1

### To set the DAY OFF (temporary change to timer)

1  During the weekly timer, press the Confirm button.

---

2  Press the button “^” or “v” to select the day in this week.

---

3  Press the Day off button to set the DAY OFF.

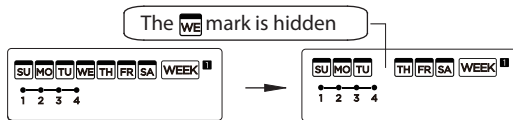

ex.The DAY OFF is set for Wednesday

---

4 The DAY OFF can be set for other days by repeating the steps 2 and 3.

---

5  Press the Back button to back to the weekly timer.

---

To cancel: Follow the same procedures as those for setup.

#### NOTE:

The DAY OFF setting is cancelled automatically after the set day has passed.

## 11. Weekly Timer 1

### DELAY function



While in weekly timer, press the FUNC. button, select the delay function and press the Confirm button, display "0h" "1h" "2h" and wait 3 seconds to confirm. When the delay function is activated, the "⌚" mark appears.



The delay function can only be enabled in Weekly Timer 1 and Weekly Timer 2.

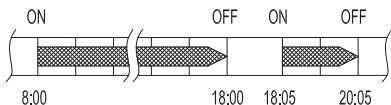
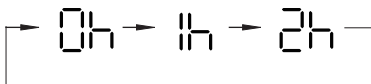

ex. Press select "2h" at 18:05, unit will delay turn off until 20:05

### Copy timer setting from one day to another day.

Timer settings can be copied to another day of the week. All timer settings of the selected day of the week will be copied.



During the weekly timer, press the Confirm button.



Press the button "∧" or "∨" to select the day to copy from.

## 11. Weekly Timer 1



Press the Copy button, the letter "CY" will be shown on the LCD.



Press the button "^" or "v" to select the day to copy to.



Press the Copy button to confirm .

The **WE** mark flashes quickly

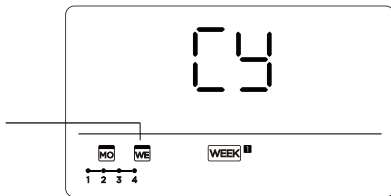

ex. Copy the setting of Monday to Wednesday

6 Other days can be copied by repeating step 4 and 5.



Press the Confirm button to confirm the settings.



Press the Back button to back to the weekly timer.

## 11. Weekly Timer 2

### 1 Weekly timer setting



Press Timer to select the **WEEK** and press Confirm.

### 2 Day of the week setting



Press "v" or "^" to select the day of the week and then press CONFIRM.



### 3 ON timer setting of timer setting 1



Press " ^ " or " v " to select the setting time. The setting time, mode, temperature and fan speed appear on the LCD. Press CONFIRM to enter the setting time process.

## 12. Weekly Timer 2

**IMPORTANT:** Up to 8 scheduled events can be set on one day.  
Various events can be scheduled in either MODE, TEMPERATURE and FAN speeds.

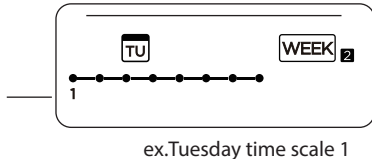

### 4 Time setting



Press " ^ " or " v " to set the time, then press CONFIRM.

### 5 Operation mode setting

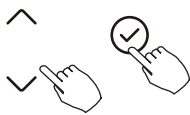

Press " ^ " or " v " to set the operation mode then press CONFIRM.

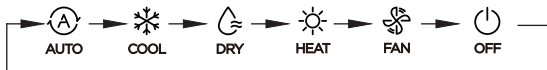

### 6 Room temperature setting

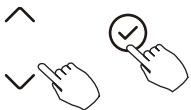

Press " ^ " or " v " to set the room temperature, then press CONFIRM.

**NOTE:** This setting is unavailable in the FAN or OFF modes.

## 12. Weekly Timer 2

### 7 Fan speed setting



Press “^” or “v” to set the fan speed then press CONFIRM.

**NOTE:** This setting is unavailable in the AUTO, DRY or OFF modes.

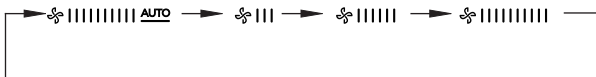

8 **Different scheduled events can be set by repeating steps 3 through 7.**

9 **Additional days, in a one week period, can be set by repeating steps 3 through 8.**

**NOTE:** The weekly timer setting can be returned to the previous step by pressing BACK. The current setting is restored. Unless you press "Confirm" controller will not save the weekly timer settings if there is no input within 30 seconds.

## 12. Weekly Timer 2

### WEEKLY timer operation

To start



Press Timer to select the **WEEK** , and then the timer starts automatically.

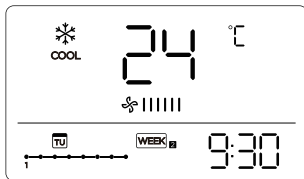

ex.

To cancel



Press the Power buttons for 2 seconds to cancel the timer mode.



The timer mode can also be canceled by changing the timer mode using Timer.

To set the DAY OFF (for a holiday)



After setting the weekly timer, press CONFIRM.

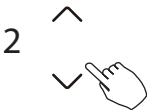

Press " ^ " or " v " to select the day of the week.

## 12. Weekly Timer 2

3



Press DAY OFF to create an off day.

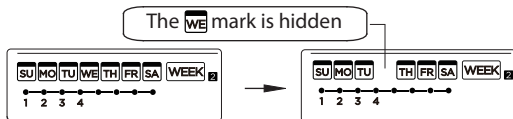

ex.The DAY OFF is set for Wednesday

4

Set the DAY OFF for other days by repeating the steps 2 and 3.

5



Press BACK to revert to the weekly timer.

To cancel, follow the same procedures used for setup.

**NOTE:** The DAY OFF setting is cancelled automatically after the set day has passed.

### Copy settings from one day into another day.

A scheduled event, made once, can be copied to another day of the week. The scheduled events of the selected day of the week will be copied.

1





In the weekly timer, press CONFIRM.

## 12. Weekly Timer 2

2  Press “^” or “v” to select the day to copy from.



3  Press COPY, the letters CY appear on the LCD.

4  Press “^” or “v” to select the day to copy to.



5  Press COPY to confirm.

The  mark flashes quickly

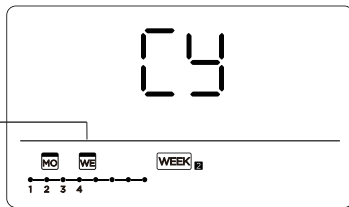

ex. Copy the setting of Monday to Wednesday

6 Other days can be copied by repeating steps 4 and 5.





7  Press CONFIRM to confirm the settings.

8  Press BACK to revert to the weekly timer.



## 12. Weekly Timer 2

### Delete timer settings for one day of the week.

1  During the weekly timer setting, press CONFIRM.

2   Press “” or “” to select the day of the week and then press CONFIRM.

3  

Press “” or “” to select the setting time want to delete. The setting time, mode, temperature and fan speed appear on the LCD. The setting time, mode, temperature and fan speed can be deleted by pressing the DEL (day off).

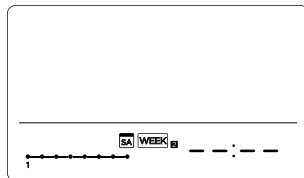
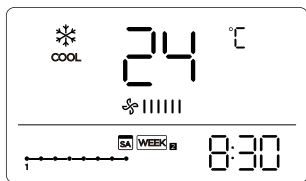

ex. Delet the time scale 1 in saturday

### 13. Troubleshooting

See below for error codes and suggested resolution.

NO.	Error Code Definition	DISPLAY DIGITAL TUBE
1	Error of communication between wire controller and indoor unit	E463

The error displayed on the thermostat are different from those on the unit. If error code appears, please check the <<Owner's And Installation Manual>>and<<SERVICE Manual>>.

### 14. Compliance Statement



EMC and EMI comply with the CE certification requirements.

## 15. Function settings



To enter setup mode, press "COPY" for 3 seconds. The first display you see is P:00, which identifies the first air handler. If connected to multiple indoor units, press  to display P:01, P:02, and then press "Confirm" to select indoor unit.



Display now shows Tn (T1~T4) temperature and fan fault(CF), press "" or "" to select.





Wait 15 seconds or press "Back" or press "ON/OFF" exit setup mode.



To adjust static pressure, the air conditioner must be off.





SP

Enter setup mode, press "" or "" to select SP, press "Confirm" to adjust the static pressure value.

\*|||||||



With air conditioner off, enter setup mode, press "" or "" to select AF, press "Confirm" to enter test mode, press "Back" or press "ON/OFF" or press "Confirm" to exit test mode. In AF mode, 3~6 minutes test completion automatically exits, or press "Back" or press "ON/OFF" or press "Confirm", will also exit test mode.



AF

\*|||||||

## 15. Function settings

### Follow me function temperature compensation



With the air conditioning unit off, enter setup mode, press “^” or “v” to select tF.



The compensation temperature Range : -5~5°C.

Press “Confirm” to make changes, press “^” or “v” to select the temperature, then press “Confirm” to save changes.

tF

tF : compensation temperature



With the air conditioning unit off, enter setup mode, press “^” or “v” to select tyPE.



Press “Confirm” to make changes, press “^” or “v” to select the type, then press “Confirm” to save changes.

tyPE

CH:   
AUTO COOL DRY HEAT FAN

HH:   
HEAT FAN

CC:   
COOL DRY FAN

NA:   
COOL DRY HEAT FAN

## 15. Function settings

### Set the highest and lowest temperature values

- ^ With the air conditioner off, enter setup mode  
press “^” or “v” to select tHI or tLo.
- ✓  Press “Confirm” to make changes, press “^” or “v” to select the temperature, then press “Confirm” again to save changes.

tHI  
tLo

The highest setting temperature range : 25~30°C

The lowest setting temperature range: 17 ~24°C.

tHI : Highest value setting function.

tLo : Minimum value setting function.

---

### Remote control function with thermostat

- ^ With the air conditioner off, enter setup mode,  
press “^” or “v” to select rEC. ON or OF will be  
displayed in the temperature area to indicate whether remote  
is communicating or not.
- ✓ 

rEC

When the selection says OF, the thermostat does not process any remote control signals.

Press “Confirm” into setting state, press “^” or “v” to select , then press “Confirm” again to save changes.

## 15. Function settings

### Two - line controller address selection



With the air conditioner off, enter setup mode,  
press“^”or“v”to select Adr.



The temperature zone will display -- or A, B. Where -- refers to  
the code setting of the thermostat.

Press “Confirm” to make changes, press“^”or“v”to select ,  
then press “Confirm” again to save changes.

Adr

-- : The code setting  of the wire controller shall prevail.

Adr : The wire controller address setting.

---

### Restore factory Settings



With the air conditioner off, enter setup mode,  
press“^”or“v”to select INit, the temperature  
zone displays "--".



Press “Confirm” to make changes, press“^”or“v”to change  
to "ON" , then press “Confirm” to restore factory settings.

INit

INit : Restore factory Settings .

## 15. Function settings

After the wire controller resumes the factory parameter setting, the rotating parameter setting is restored to 10 hours (the highest and lowest temperature are not set); The compensation of body temperature is uncompensated; COOL and HEAT/single COOL mode is restored to COOL and HEAT model;

Restore the temperature range to the factory setting.

Remote receiving function is restored to be effective;

The address of the two-control first-line controller is restored to the code switch.

## 16.WiFicontrol connection

### SAFETY PRECAUTION

- Read the safety precautions carefully before installing the unit.
- Stated below are important safety issues that must be obeyed.  
Applicable system: IOS, Android. (Suggest: IOS 9.0 and above, Android 6.0 and above.)

### NOTE:

- Due to frequent OS upgrades , not all Andriod and IOS systems are compatible with APP.We can not be responsible for any incompatibility as a result of outdated OS.

### Wireless safety strategy

- Smart kit only supports WPA-PSK/WPA2-PSK encryption and no encryption . WPA-PSK/WPA2-PSK encryption is recommended.

## 16.WiFi control connection



### CAUTION

- Please Check The Service Website For More Information.
- Smart Phone camera needs to be 5 million pixels or above to make sure scan QR code well.
- Due to different networks, sometimes network time-out errors can occur. It may be necessary to restart network configuration.
- Due to different networks, control process may return time-out sometimes. If this situation occurs, there may be a delay between unit display and App. Simply enter your desired input again.

### NOTE:

Company will not be liable for any issues and problems caused by Internet, Wireless Router and Smart Devices. Please contact the original provider to get further help.

## 16.WiFi control connection

### DOWNLOAD AND INSTALL APP

On an app market (Google Play Store, Apple App Store), search for "NetHome Plus" and find the NetHome Plus app. Download and install it on your phone, You can also download the app by scanning the QR code below.



**Android**



**iOS**

- Please ensure your mobile device is connected to Wireless Network router. Also, the Wireless Network router is connected to Internet before user registration and network configuration.
- If you have older/ other networks stored in your mobile device - you may wish to forget them to remove a possible configuration error.

## 16.WiFi control connection



### NETWORK CONFIGURATION



#### CAUTION

- It is necessary to forget any other around network and make sure the Android or IOS device just connect to the Wireless Network you want to configure.
- Make sure the Android or IOS device Wireless Network function works well and can be connected back to your original Wireless Network network automatically.

#### Enter AP mode for network discovery

Press the FUNC. button until the  icon is selected and then press the CONFIRM button. AP mode is activated if the  icon is blinking.

## 16.WiFi control connection

### Network configuration by Bluetooth scan

Note: Make sure the bluetooth of your mobile device is working.

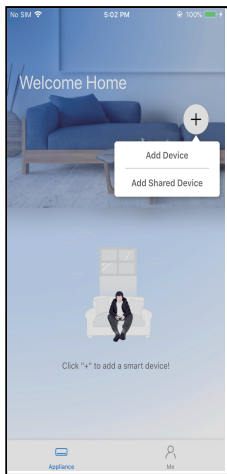

① Press “ + Add Device ”

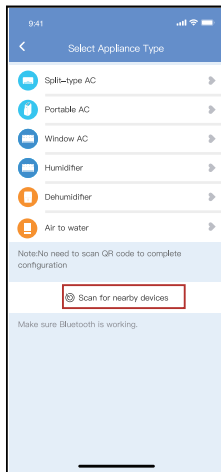

② Press “Scan for nearby devices”

## 16.WiFi control connection

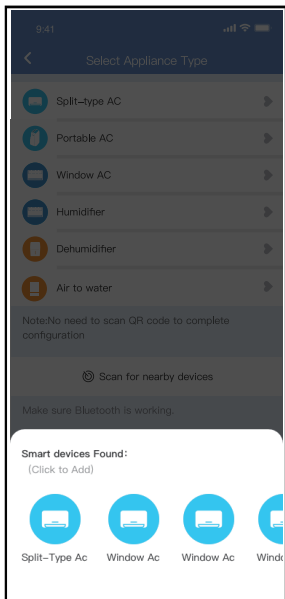

- ③ Wait to find smart devices, then click to add

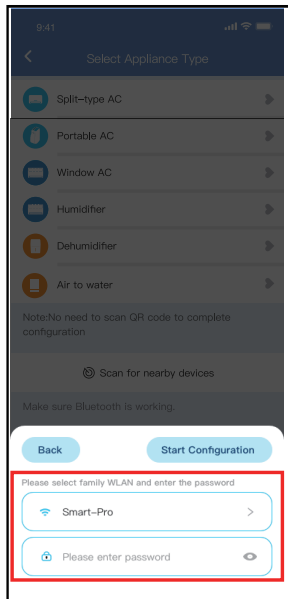

- ④ Select your network, enter the password

## 16.WiFi control connection

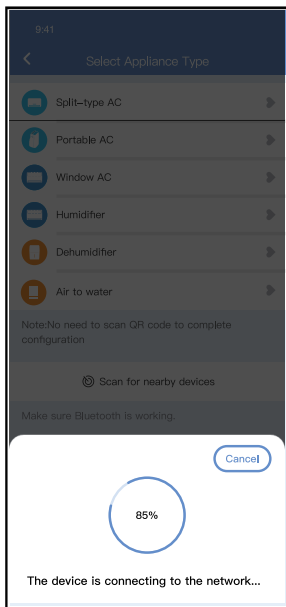

- ⑤ Wait for network connection

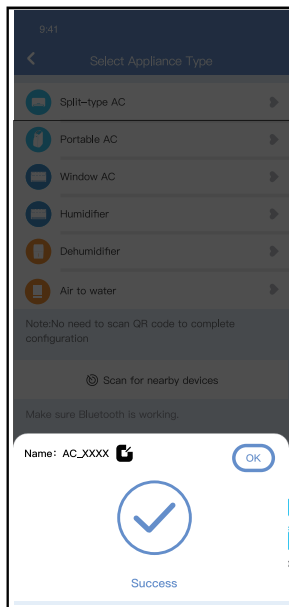

- ⑥ Configuration Success, you can modify the default name.

## 16. WiFicontrol connection

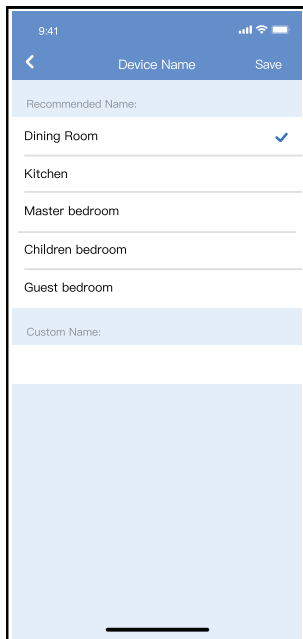

- ⑦ You can choose an existing name or customize a new name.

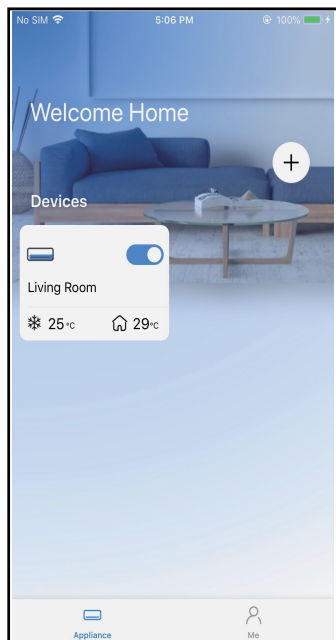

- ⑧ Bluetooth network configuration is successful, now you can see the device in the list.

## 16.WiFi control connection

### NOTE:

- Make sure your devices are powered on.
- Keep your mobile phone close enough to your device when you are connecting network to your device.
- Connect your mobile phone to the wireless network at home, and make sure you know the password of the Wireless Network.
- Check if your router supports 2.4 GHz Wireless Network band and turn it on. If you are not sure whether the router supports 2.4 GHz band, please contact the router manufacturer.
- The device cannot connect to the Wireless Network that requires authentication, and it usually appears in public area such as hotels, restaurants, etc. Please connect to a Wireless that does not require authentication.
- It is recommended to use a Wireless Network name that only contains letters and numbers. If your Wireless Network name contains special characters, please modify it in the router.
- Turn off the WLAN+ (Android) or WLAN Assistant (iOS) function of your mobile phone when connecting network to your devices.
- In the case that your device connected to Wireless Network before but it needs to reconnect, please click "+" on app Home page, and add your device again by the device category and model according to the instructions on app.

## 16. Wireless control connection

### APP DECLARATION

Hereby, we declare that this Smart kit is in compliance with the essential requirements and other relevant provisions of Directive 2014/53/EU. A copy of the full DoC is attached. (European Union products only)

### CAUTIONS:

**Wireless Network module models: US-SK107, EU-SK107:**

FCC ID: 2ADQOMDNA21

IC: 12575A-MDNA21

This device complies with Part 15 of the FCC Rules and it contains licence-exempt transmitter(s)/receiver(s) that comply with Innovation, Science and Economic Development Canada's licence-exempt RSS(s).

Operation is subject to the following two conditions:

- (1) This device may not cause interference; and
- (2) This device must accept any interference, including interference that may cause undesired operation of the device.

Only operate the device in accordance with the instructions supplied. Changes or modifications to this unit not expressly approved by the party responsible for compliance could void the user's authority to operate the equipment.

This device complies with FCC radiation exposure limits set forth for an uncontrolled environment. In order to avoid the possibility of exceeding the FCC radio frequency exposure limits, human proximity to the antenna shall not be less than 20cm (8 inches) during normal operation.

## 16. Wireless control connection

### NOTE:

This equipment has been tested and found to comply with the limits for a Class B digital device, pursuant to part 15 of FCC Rules. These limits are designed to provide reasonable protection against harmful interference in a residential installation. This equipment generates, uses and can radiate radio frequency energy and, if not installed and used in accordance with the instructions, may cause harmful interference to radio communications. However, there is no guarantee that interference will not occur in a particular installation. If this equipment does cause harmful interference to radio or television reception, which can be determined by turning the equipment off and on, the user is encouraged to try to correct the interference by one or more of the following measures:

- Reorient or relocate the receiving antenna.
- Increase the separation between the equipment and receiver.
- Connect the equipment into an outlet on a circuit different from that to which the receiver is connected.
- Consult the dealer or an experienced radio/TV technician for help.

## Breezeless function of dip switch.

**NTOE:** This feature is only available under cool mode.

This feature is for some models.

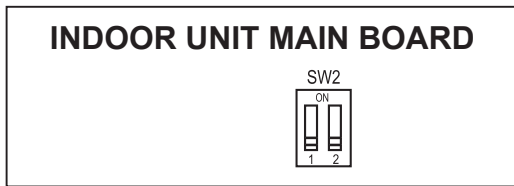

SW2 has 2 dip switch: SW2-1 and SW2-2

SW2-2 is to control the breezeless function.

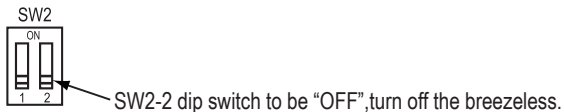
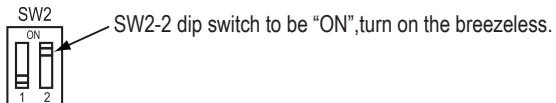
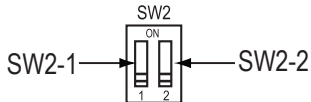

The design and specifications are subject to change without prior notice for product improvement. Consult with the sales agency or manufacturer for details.

