

Service and Troubleshooting

***MVS80*U**

SINGLE STAGE VARIABLE SPEED ULTRA-LOW NOx GAS FURNACES AND ACCESSORIES

Pride and workmanship go into every product to provide our customers with quality products. It is possible, however, that during its lifetime a product may require service. Products should be serviced only by a qualified service technician who is familiar with the safety procedures required in the repair and who is equipped with the proper tools, parts, testing instruments and the appropriate service manual. **REVIEW ALL SERVICE INFORMATION IN THE APPROPRIATE SERVICE MANUAL BEFORE BEGINNING REPAIRS.**

TABLE OF CONTENTS

| | |
|--|----|
| IMPORTANT INFORMATION..... | 2 |
| PRODUCT IDENTIFICATION | 4 |
| SYSTEM OPERATION..... | 6 |
| SCHEDULED MAINTENANCE | 20 |
| SERVICING..... | 23 |
| CHECKING VOLTAGE | 23 |
| CHECKING WIRING | 23 |
| CHECKING THERMOSTAT, WIRING..... | 23 |
| CHECKING TRANSFORMER AND CONTROL CIRCUIT | 23 |
| CHECKING AIR CIRCULATOR BLOWER MOTOR | 24 |
| CHECKING DUCT STATIC..... | 24 |
| CHECKING TEMPERATURE RISE | 24 |
| CHECKING PRIMARY LIMIT CONTROL | 25 |
| CHECKING AUXILIARY LIMIT CONTROL..... | 25 |
| INDUCED DRAFT BLOWER MOTOR | 26 |
| CHECKING GAS VALVE (REDUNDANT) | 26 |
| CHECKING GAS PRESSURE | 26 |
| CHECKING HOT SURFACE IGNITER..... | 28 |
| CHECKING PRESSURE TRANSDUCER | 28 |
| CHECKING FOR DELAYED IGNITION..... | 29 |
| CHECKING INTEGRATED IGNITION CONTROL BOARDS | 29 |
| CHECKING FLAME SENSOR..... | 29 |
| TROUBLESHOOTING CHART | 30 |
| WIRING DIAGRAMS..... | 37 |



WARNING

ONLY PERSONNEL THAT HAVE BEEN TRAINED TO INSTALL, ADJUST, SERVICE OR REPAIR (HEREINAFTER, "SERVICE") THE EQUIPMENT SPECIFIED IN THIS MANUAL SHOULD SERVICE THE EQUIPMENT. THE MANUFACTURER WILL NOT BE RESPONSIBLE FOR ANY INJURY OR PROPERTY DAMAGE ARISING FROM IMPROPER SERVICE OR SERVICE PROCEDURES. IF YOU SERVICE THIS UNIT, YOU ASSUME RESPONSIBILITY FOR ANY INJURY OR PROPERTY DAMAGE WHICH MAY RESULT. IN ADDITION, IN JURISDICTIONS THAT REQUIRE ONE OR MORE LICENSES TO SERVICE THE EQUIPMENT SPECIFIED IN THIS MANUAL, ONLY LICENSED PERSONNEL SHOULD SERVICE THE EQUIPMENT. IMPROPER INSTALLATION, ADJUSTMENT, SERVICING OR REPAIR OF THE EQUIPMENT SPECIFIED IN THIS MANUAL, OR ATTEMPTING TO INSTALL, ADJUST, SERVICE OR REPAIR THE EQUIPMENT SPECIFIED IN THIS MANUAL WITHOUT PROPER TRAINING MAY RESULT IN PRODUCT DAMAGE, PROPERTY DAMAGE, PERSONAL INJURY OR DEATH.

PROP 65 WARNING FOR CALIFORNIA CONSUMERS



WARNING

Cancer and Reproductive Harm -
www.P65Warnings.ca.gov

0140M00517-A

RS6612019r1
October 2020

IMPORTANT INFORMATION

IMPORTANT NOTICES FOR CONSUMERS AND SERVICERS RECOGNIZE SAFETY SYMBOLS, WORDS AND LABELS

Pride and workmanship go into every product to provide our customers with quality products. It is possible, however, that during its lifetime a product may require service. Products should be serviced only by a qualified service technician who is familiar with the safety procedures required in the repair and who is equipped with the proper tools, parts, testing instruments and the appropriate service manual. **REVIEW ALL SERVICE INFORMATION IN THE APPROPRIATE SERVICE MANUAL BEFORE BEGINNING REPAIRS.**

WARNING

THIS UNIT SHOULD NOT BE CONNECTED TO, OR USED IN CONJUNCTION WITH, ANY DEVICES THAT ARE NOT DESIGN CERTIFIED FOR USE WITH THIS UNIT OR HAVE NOT BEEN TESTED AND APPROVED BY THE MANUFACTURER. SERIOUS PROPERTY DAMAGE OR PERSONAL INJURY, REDUCED UNIT PERFORMANCE AND/OR HAZARDOUS CONDITIONS MAY RESULT FROM THE USE OF DEVICES THAT HAVE NOT BEEN APPROVED OR CERTIFIED BY THE MANUFACTURER.

WARNING

TO PREVENT THE RISK OF PROPERTY DAMAGE, PERSONAL INJURY, OR DEATH, DO NOT STORE COMBUSTIBLE MATERIALS OR USE GASOLINE OR OTHER FLAMMABLE LIQUIDS OR VAPORS IN THE VICINITY OF THIS APPLIANCE.

WARNING

HIGH VOLTAGE
DISCONNECT ALL POWER BEFORE SERVICING OR INSTALLING THIS UNIT. MULTIPLE POWER SOURCES MAY BE PRESENT. FAILURE TO DO SO MAY CAUSE PROPERTY DAMAGE, PERSONAL INJURY OR DEATH.

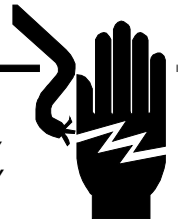

OUTSIDE THE U.S., call 1-713-861-2500.
(Not a technical assistance line for dealers.) Your telephone company will bill you for the call.

IMPORTANT INFORMATION



WARNING

IF THE INFORMATION IN THESE INSTRUCTIONS IS NOT FOLLOWED EXACTLY, A FIRE OR EXPLOSION MAY RESULT CAUSING PROPERTY DAMAGE, PERSONAL INJURY OR LOSS OF LIFE.

- DO NOT STORE OR USE GASOLINE OR OTHER FLAMMABLE VAPORS AND LIQUIDS IN THE VICINITY OF THIS OR ANY OTHER APPLIANCE.

- **WHAT TO DO IF YOU SMELL GAS:**
 - DO NOT TRY TO LIGHT ANY APPLIANCE.
 - DO NOT TOUCH ANY ELECTRICAL SWITCH; DO NOT USE ANY PHONE IN YOUR BUILDING.
 - IMMEDIATELY CALL YOUR GAS SUPPLIER FROM A NEIGHBOR'S PHONE. FOLLOW THE GAS SUPPLIER'S INSTRUCTIONS.
 - IF YOU CANNOT REACH YOUR GAS SUPPLIER, CALL THE FIRE DEPARTMENT.

- INSTALLATION AND SERVICE MUST BE PERFORMED BY A QUALIFIED INSTALLER, SERVICE AGENCY OR THE GAS SUPPLIER.



WARNING

SHOULD OVERHEATING OCCUR OR THE GAS SUPPLY FAIL TO SHUT OFF, TURN OFF THE MANUAL GAS SHUTOFF VALVE EXTERNAL TO THE FURNACE BEFORE TURNING OFF THE ELECTRICAL SUPPLY.



DANGER PELIGRO



CARBON MONOXIDE POISONING HAZARD

Special Warning for Installation of Furnace or Air Handling Units in Enclosed Areas such as Garages, Utility Rooms or Parking Areas

Carbon monoxide producing devices (such as an automobile, space heater, gas water heater, etc.) should not be operated in enclosed areas such as unventilated garages, utility rooms or parking areas because of the danger of carbon monoxide (CO) poisoning resulting from the exhaust emissions. If a furnace or air handler is installed in an enclosed area such as a garage, utility room or parking area and a carbon monoxide producing device is operated therein, there must be adequate, direct outside ventilation.

This ventilation is necessary to avoid the danger of CO poisoning which can occur if a carbon monoxide producing device continues to operate in the enclosed area. Carbon monoxide emissions can be (re)circulated throughout the structure if the furnace or air handler is operating in any mode.

CO can cause serious illness including permanent brain damage or death.

B10259-216

RIESGO DE INTOXICACIÓN POR MONÓXIDO DE CARBONO

Advertencia especial para la instalación de calentadores ó manejadoras de aire en áreas cerradas como estacionamientos ó cuartos de servicio.

Los equipos ó aparatos que producen monóxido de carbono (tal como automóvil, calentador de gas, calentador de agua por medio de gas, etc) no deben ser operados en áreas cerradas debido al riesgo de envenenamiento por monóxido de carbono (CO) que resulta de las emisiones de gases de combustión. Si el equipo ó aparato se opera en dichas áreas, debe existir una adecuada ventilación directa al exterior. Esta ventilación es necesaria para evitar el peligro de envenenamiento por CO, que puede ocurrir si un dispositivo que produce monóxido de carbono sigue operando en el lugar cerrado.

Las emisiones de monóxido de carbono pueden circular a través del aparato cuando se opera en cualquier modo.

El monóxido de carbono puede causar enfermedades severas como daño cerebral permanente ó muerte.

B10259-216

RISQUE D'EMPOISONNEMENT AU MONOXYDE DE CARBONE

Avertissement special au sujet de l'installation d'appareils de chauffage ou de traitement d'air dans des endroits clos, tels les garages, les locaux d'entretien et les stationnements.

Evitez de mettre en marche les appareils produisant du monoxyde de carbone (tels que les automobile, les appareils de chauffage autonome, etc.) dans des endroits non ventilés tels que les d'empoisonnement au monoxyde de carbone. Si vous devez faire fonctionner ces appareils dans un endroit clos, assurez-vous qu'il y ait une ventilation directe provenant de l'exterieur.

Cette ventilation est nécessaire pour éviter le danger d'intoxication au CO pouvant survenir si un appareil produisant du monoxyde de carbone continue de fonctionner au sein de la zone confinée.

Les émissions de monoxyde de carbone peuvent être recirculés dans les endroits clos, si l'appareil de chauffage ou de traitement d'air sont en marche.

Le monoxyde de carbone peut causer des maladies graves telles que des dommages permanents au cerveau et même la mort.

B10259-216

PRODUCT IDENTIFICATION

NOMENCLATURE

The model and manufacturing number are used for positive identification of component parts used in manufacturing. Please use these numbers when requesting service or parts information.

| Furnace Nomenclature | | | | | | | | | | | | | | | |
|---------------------------------|---|---|---|---|---|---|---|---|---|----|----|----|----|----|-----------------------|
| | * | M | E | S | 9 | 6 | 0 | 6 | 0 | 3 | B | N | A | A | |
| | 1 | 2 | 3 | 4 | 5 | 6 | 7 | 8 | 9 | 10 | 11 | 12 | 13 | 14 | |
| Brand | | | | | | | | | | | | | | | Minor Revision |
| A - Amana® Brand G- Goodman® | | | | | | | | | | | | | | | A - Initial Release |
| V - GMC® | | | | | | | | | | | | | | | B - 1st Revision |
| Configuration | | | | | | | | | | | | | | | Major Revision |
| M - Upflow/Horizontal | | | | | | | | | | | | | | | A - Initial Release |
| C - Downflow/Horizontal | | | | | | | | | | | | | | | B - 1st Revision |
| Airflow | | | | | | | | | | | | | | | Nox |
| V - Variable Speed/ComfortNet | | | | | | | | | | | | | | | N - Natural Gas |
| E - High Efficiency Multi Speed | | | | | | | | | | | | | | | X - Low Nox |
| S - Single Speed | | | | | | | | | | | | | | | U - Ultra - Low Nox |
| Gas Valve Stages | | | | | | | | | | | | | | | Cabinet Width |
| M - Modulating | | | | | | | | | | | | | | | A - 14" |
| V - 2 Stage | | | | | | | | | | | | | | | B - 17.5" |
| S - Single Stage | | | | | | | | | | | | | | | C - 21" |
| | | | | | | | | | | | | | | | D - 24.5" |
| AFUE | | | | | | | | | | | | | | | Maximum CFM |
| 97 - 97% AFUE | | | | | | | | | | | | | | | 3 - 1200 CFM |
| 80 - 80% AFUE | | | | | | | | | | | | | | | 4 - 1600 CFM |
| 92 - 92% AFUE | | | | | | | | | | | | | | | 5 - 2000 CFM |
| 80 - 80% AFUE | | | | | | | | | | | | | | | |
| MBTU/h | | | | | | | | | | | | | | | |
| 040 - 40,000 | | | | | | | | | | | | | | | |
| 060 - 60,000 | | | | | | | | | | | | | | | |
| 080 - 80,000 | | | | | | | | | | | | | | | |

PRODUCT IDENTIFICATION

| MODEL FAMILY | MODEL | DESCRIPTION |
|-------------------------------------|--|---|
| <p align="center">AMVS80</p> | <p>AMVS800604BU AA AMVS800805CU AA</p> | <p>Amana ® Brand 80% Ultra-Low NOx Gas Furnace, Eligible for installation in California's South Coast Air Quality Management District (SCAQMD) and San Joaquin Valley Air Pollution Control District (SJVUAPCD). This furnace complies with the 14 ng/J NOx emission limit in SCAQMD Rule 1111 and SJVUAPCD Rule 4905. This furnace is eligible for the SCAQMD Clean Air Furnace Rebate Program: www.CleanAirFurnaceRebate.com. Up flow/Horizontal Left and Right, Induced Draft, Nidec variable speed ECM motor. Stainless Steel tubular heat exchanger. 115 volt silicon nitride igniter. Left or right gas entry. Line voltage EAC terminal</p> |
| <p align="center">GMVS80</p> | <p>GMVS800604BU AA GMVS800805CU AA</p> | <p>Goodman ® Brand 80% Ultra-Low NOx Gas Furnace, Eligible for installation in California's South Coast Air Quality Management District (SCAQMD) and San Joaquin Valley Air Pollution Control District (SJVUAPCD). This furnace complies with the 14 ng/J NOx emission limit in SCAQMD Rule 1111 and SJVUAPCD Rule 4905. This furnace is eligible for the SCAQMD Clean Air Furnace Rebate Program: www.CleanAirFurnaceRebate.com. Up flow/Horizontal Left and Right, Induced Draft, Nidec variable speed ECM motor. Stainless Steel tubular heat exchanger. 115 volt silicon nitride igniter. Left or right gas entry. Line voltage EAC terminal</p> |

SYSTEM OPERATION

Safety

Please adhere to the following warnings and cautions when installing, adjusting, altering, servicing, or operating the furnace.

WARNING

TO PREVENT PERSONAL INJURY OR DEATH DUE TO IMPROPER INSTALLATION, ADJUSTMENT, ALTERATION, SERVICE OR MAINTENANCE, REFER TO THIS MANUAL. FOR ADDITIONAL ASSISTANCE OR INFORMATION, CONSULT A QUALIFIED INSTALLER, SERVICE AGENCY OR THE GAS SUPPLIER.

WARNING

TO PREVENT POSSIBLE PROPERTY DAMAGE, PERSONAL INJURY OR DEATH DUE TO ELECTRICAL SHOCK, THE FURNACE MUST BE LOCATED TO PROTECT THE ELECTRICAL COMPONENTS FROM WATER.

Charge (ESD) Precautions

NOTE: Discharge your body's static electricity before touching unit. An electrostatic discharge can adversely affect electrical components.

Use the following precautions during furnace installation and servicing to protect the integrated control module from damage. By putting the furnace, the control, and the person at the same electrostatic potential, these steps will help avoid exposing the integrated control module to electrostatic discharge. This procedure is applicable to both installed and uninstalled (ungrounded) furnaces.

1. Disconnect all power to the furnace. Do not touch the integrated control module or any wire connected to the control prior to discharging your body's electrostatic charge to ground.
2. Firmly touch a clean, unpainted, metal surface of the furnace near the control. Any tools held in a person's hand during grounding will be discharged.
3. Service integrated control module or connecting wiring following the discharge process in Step 2. Use caution not to recharge your body with static electricity; (i.e., do not move or shuffle your feet, do not touch ungrounded objects, etc.). If you come in contact with an ungrounded object, repeat Step 2 before touching control or wires.
4. Discharge any static electricity from your body to ground before removing a new control from its container. Follow Steps 1 through 3 if installing the control on a furnace. Return any old or new controls to their containers before touching any ungrounded object.

Product Application

This product is designed for use as a residential home gas furnace. It is **not** designed or certified for use in mobile home, trailer, or recreational vehicle applications.

In the U.S.A., this furnace can be used in the following non-industrial commercial applications: Schools, Office buildings, Churches, Retail stores, Nursing homes, Hotels/motels, Common or office areas. In all applications, the furnace must be installed per the installation instructions.

Goodman® brand GMVS80*U and Amana® brand AMVS80*U furnaces are ETL certified. All *MVS80*U furnaces are built for use with Natural gas only & may not be converted for use with LP gas.

To ensure proper installation, operation and servicing, thoroughly read the installation and service manuals for specifics pertaining to the installation, servicing and application of this product.

WARNING

POSSIBLE PROPERTY DAMAGE, PERSONAL INJURY OR DEATH DUE TO FIRE, EXPLOSION, SMOKE, SOOT, CONDENSTAIION, ELECTRICAL SHOCK OR CARBON MONOXIDE MAY RESULT FROM IMPROPER INSTALLATION, REPAIR, OPERATION, OR MAINTENANCE OF THIS PRODUCT.

WARNING

TO PREVENT PROPERTY DAMAGE, PERSONAL INJURY OR DEATH DUE TO FIRE, DO NOT INSTALL THIS FURNACE IN A MOBILE HOME, TRAILER, OR RECREATIONAL VEHICLE.

To ensure proper furnace operation, install, operate, maintain and service the furnace in accordance with the installation, operation and service instructions, all local building codes and ordinances. In their absence, follow the latest edition of the National Fuel Gas Code (NFPA 54/ANSI Z223.1), and/or CAN/CGA B149 Installation Codes, local plumbing or waste water codes, and other applicable codes.

EMI Filter (Electromagnetic Interference Filter)

All *MVS80*U furnaces must have an EMI Filter installed.

Early production furnaces will require the EMI filter to be field installed at the time of furnace installation as furnaces are shipped without this component. The kit (EMIULN-1) is available from your furnace distributor at no cost.

The purpose of the EMI Filter is to reduce electromagnetic interference between the furnace and other electrical devices.

A copy of the National Fuel Gas Code (NFPA 54/ANSI Z223.1) can be obtained from any of the following:

American National Standards Institute
25 West 43rd Street, 4th Floor
New York, NY 10036

National Fire Protection Association
1 Batterymarch Park
Quincy, MA 02169-7471

SYSTEM OPERATION

CSA International
8501 East Pleasant Valley
Cleveland, OH 44131

A copy of the CAN/CGA B149 Installation Codes can be obtained from:

CSA International
178 Rexdale Boulevard
Etobicoke, Ontario, Canada M9W, 1R3

The rated heating capacity of the furnace should be greater than or equal to the total heat loss of the area to be heated. The total heat loss should be calculated by an approved method or in accordance with "ASHRAE Guide" or "Manual J-Load Calculations" published by the Air Conditioning Contractors of America.

 **WARNING**

DO NOT OPERATE THE FURNACE WITH THE RAIN CAP REMOVED AS RECIRCULATION OF THE FLUE GASES MAY OCCUR. WATER MAY ALSO COLLECT INSIDE THE LARGER COMBUSTION AIR PIPE AND FLOW TO THE BURNER ENCLOSURE. FAILURE TO FOLLOW THIS WARNING CAN RESULT IN PROPERTY DAMAGE, EQUIPMENT DAMAGE, PERSONAL INJURY OR DEATH.

 **WARNING**

IN UPRIGHT UPFLOW INSTALLATIONS, THE DRAIN TRAP MUST BE MOUNTED ON THE OPPOSITE SIDE OF THE UNIT FROM THE JUNCTION BOX. THIS WILL REDUCE THE RISK OF WATER REACHING THE JUNCTION BOX IN THE EVENT OF A BLOCKED DRAIN CONDITION. FAILURE TO FOLLOW THESE INSTRUCTIONS CAN RESULT IN POSSIBLE PROPERTY DAMAGE, PERSONAL INJURY, OR DEATH DUE TO ELECTRICAL SHOCK.

GAS SUPPLY AND PIPING

The furnace rating plate includes the approved furnace gas input rating.

 **CAUTION**

TO PREVENT UNRELIABLE OPERATION OR EQUIPMENT DAMAGE, THE INLET GAS SUPPLY PRESSURE MUST BE AS SPECIFIED ON THE UNIT RATING PLATE WITH ALL OTHER HOUSEHOLD GAS FIRED APPLIANCES OPERATING.

Inlet gas supply pressures must be maintained within the ranges specified below. The supply pressure must be constant and available with all other household gas fired appliances operating. The minimum gas supply pressure must be maintained to prevent unreliable ignition. The maximum must not be exceeded to prevent unit overfiring.

| INLET GAS SUPPLY PRESSURE | | |
|---------------------------|--------------------|---------------------|
| Natural Gas | Minimum: 4.5" w.c. | Maximum: 10.0" w.c. |

GAS VALVE

This unit is equipped with a 24 volt gas valve controlled during furnace operation by the integrated control module. Taps for measuring the gas supply pressure and manifold pressure are provided on the valve.

NOTE: The gas supply pressure on White-Rodgers "J" model gas valve, used on single stage furnaces, can be checked with a gas pressure test kit (Part #0151K0000S) available through our authorized distributors.

The gas valve has a manual ON/OFF control located on the valve itself. This control may be set only to the "ON" or "OFF" position. Refer to the *Lighting Instructions Label* or the *"Putting the Furnace Into Operation"* section of this manual or the installation instructions for use of this control during start up and shut down periods.

| Natural Gas Capacity of Pipe | | | | | |
|-------------------------------------|-------------------------|------|-----|--------|--------|
| In Cubic Feet of Gas Per Hour (CFH) | | | | | |
| Length of Pipe in Feet | Nominal Black Pipe Size | | | | |
| | 1/2" | 3/4" | 1" | 1 1/4" | 1 1/2" |
| 10 | 132 | 278 | 520 | 1050 | 1600 |
| 20 | 92 | 190 | 350 | 730 | 1100 |
| 30 | 73 | 152 | 285 | 590 | 980 |
| 40 | 63 | 130 | 245 | 500 | 760 |
| 50 | 56 | 115 | 215 | 440 | 670 |
| 60 | 50 | 105 | 195 | 400 | 610 |
| 70 | 46 | 96 | 180 | 370 | 560 |
| 80 | 43 | 90 | 170 | 350 | 530 |
| 90 | 40 | 84 | 160 | 320 | 490 |
| 100 | 38 | 79 | 150 | 305 | 460 |

(Pressure 0.5 psig or less and pressure drop of 0.3" W.C.; Based on 0.60 Specific Gravity Gas)

$$CFH = \frac{BTUH \text{ Furnace Input}}{\text{Heating Value of Gas (BTU/Cubic Foot)}}$$

GAS PIPING CHECKS

Before placing unit in operation or after servicing, leak test gas connections.

 **WARNING**

TO AVOID THE POSSIBILITY OF EXPLOSION OR FIRE, NEVER USE A MATCH OR OPEN FLAME TO TEST FOR LEAKS.

Check for leaks using an approved chloride-free soap and water solution, an electronic combustible gas detector, or other approved testing methods.

NOTE: Never exceed specified pressures for testing. Higher pressure may damage the gas valve and cause subsequent overfiring, resulting in heat exchanger failure. Disconnect this unit and shutoff valve from the gas supply piping system before pressure testing the supply piping system with pressures in excess of 1/2 psig (3.48 kPa). Isolate this unit from the gas supply piping system by closing its external manual gas shutoff valve before pressure testing supply piping system with test pressures equal to or less than 1/2 psig (3.48 kPa).

SYSTEM OPERATION

WARNING

AN UNDETECTED GAS LEAK WILL CREATE A DANGER OF EXPLOSION OR FIRE. IF THE PRESENCE OF GAS IS SUSPECTED, FOLLOW THE INSTRUCTIONS ON THE COVER OF THIS MANUAL. FAILURE TO DO SO COULD RESULT IN SERIOUS PERSONAL INJURY OR DEATH.

WARNING

IF THE INFORMATION IN THESE INSTRUCTIONS IS NOT FOLLOWED EXACTLY, A FIRE OR EXPLOSION MAY RESULT CAUSING PROPERTY DAMAGE, PERSONAL INJURY OR LOSS OF LIFE.

- DO NOT STORE OR USE GASOLINE OR OTHER FLAMMABLE VAPORS AND LIQUIDS IN THE VICINITY OF THIS OR ANY OTHER APPLIANCE.

- WHAT TO DO IF YOU SMELL GAS:

- DO NOT TRY TO LIGHT ANY APPLIANCE.
- DO NOT TOUCH ANY ELECTRICAL SWITCH; DO NOT USE ANY PHONE IN YOUR BUILDING.
- IMMEDIATELY CALL YOUR GAS SUPPLIER FROM A NEIGHBOR'S PHONE. FOLLOW THE GAS SUPPLIER'S INSTRUCTIONS.
- IF YOU CANNOT REACH YOUR GAS SUPPLIER, CALL THE FIRE DEPARTMENT.

- INSTALLATION AND SERVICE MUST BE PERFORMED BY A QUALIFIED INSTALLER, SERVICE AGENCY OR THE GAS SUPPLIER.

HIGH ALTITUDE DERATE

The furnace, as shipped, requires no change to run between 0-4500 feet. At all altitudes the air temperature rise must be within the range listed on the Specification Sheet applicable to your model for the fuel used. Manifold pressure adjustments and combustion analysis are required for all installations above 4500 ft. Refer to "Gas Supply Pressure Measurement" section for instruction on how to properly measure and adjust manifold "outlet" pressure. The furnace should operate for a minimum of 15 minutes before taking a combustion sample. Combustion samples should be taken from beyond the furnace exhaust and must be within provided CO₂% range. See table below for recommended manifold pressure adjustments and proper CO₂% range. Gas heating values can vary; further pressure adjustment may be necessary to ensure furnace operates within acceptable CO₂ range.

| Model | Manifold Pressure at 5000 ft | Manifold Pressure at 7500 ft | CO ₂ % Natural Gas |
|-------|------------------------------|------------------------------|-------------------------------|
| 40 | 2.5" w.c. | 2.4" w.c. | 5.5 – 7.0 |
| 60 | 2.5" w.c. | 2.4" w.c. | 5.7 – 7.2 |
| 80 | 2.5" w.c. | 2.4" w.c. | 6.0 – 7.5 |

ELECTRICAL CONNECTIONS

WARNING

TO AVOID THE RISK OF ELECTRICAL SHOCK, WIRING TO THE UNIT MUST BE PROPERLY POLARIZED AND GROUNDED.

WARNING

HIGH VOLTAGE

DISCONNECT ALL POWER BEFORE SERVICING OR INSTALLING THIS UNIT. MULTIPLE POWER SOURCES MAY BE PRESENT. FAILURE TO DO SO MAY CAUSE PROPERTY DAMAGE, PERSONAL INJURY OR DEATH.

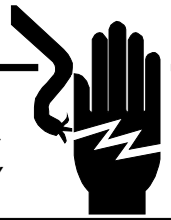

CAUTION

LABEL ALL WIRES PRIOR TO DISCONNECTION WHEN SERVICING CONTROLS. WIRING ERRORS CAN CAUSE IMPROPER AND DANGEROUS OPERATION. VERIFY PROPER OPERATION AFTER SERVICING.

CAUTION

EDGES OF SHEET METAL HOLES MAY BE SHARP. USE GLOVES AS PRECAUTION WHEN REMOVING HOLE PLUGS.

WARNING

TO AVOID THE RISK OF ELECTRICAL SHOCK, INJURY, OR DEATH, THE FURNACE MUST BE ELECTRICALLY GROUNDED IN ACCORDANCE WITH LOCAL CODES OR, IN THEIR ABSENCE, WITH THE LATEST EDITION OF THE NATIONAL ELECTRIC CODE.

WARNING

HIGH VOLTAGE

DISCONNECT ALL POWER BEFORE SERVICING OR CHANGING ANY ELECTRICAL WIRING. MULTIPLE POWER SOURCES MAY BE PRESENT. FAILURE TO DO SO MAY CAUSE PROPERTY DAMAGE, PERSONAL INJURY OR DEATH.

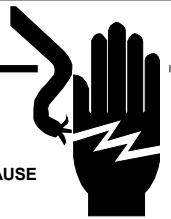

24 VOLT THERMOSTAT WIRING

NOTE: Low voltage connections can be made through either the right or left side panel. Wire routing must not interfere with circulator blower operation, filter removal, or routine maintenance.

A 40 V.A. transformer and an integrated electronic control are built into the furnace to allow use with most cooling equipment. Consult the wiring diagram, located in the Technical Manual or on the blower door for further details of 115 Volt and 24 Volt wiring.

The single stage furnace will have a "W" terminal and will use a single stage thermostat. The following drawing illustrates the typical field wiring for a heat only single stage system and a single stage heating/single stage cooling system. Refer to the following figures for proper connections to the integrated control module.

EXTREMELY IMPORTANT: This system does not contain an O wire input (reversing valve signal). If a heat pump is installed, the thermostat should be setup for single stage heat/single stage cool installs (W= Heat Call and Y = Cool Call). Setting thermostat for heat pump control will result in incorrect performance.

SYSTEM OPERATION

QUICK START GUIDE

- 1) Connect all necessary thermostat wires to the thermostat connector on the furnace control (only available connections on the furnace are R & C for power, Y for Cooling Calls, W for Heating Calls, G for Fan Calls, Dehum for Dehumidification Calls. Furnace will control staging of indoor unit and outdoor unit automatically based on these inputs).
- 2) Make sure thermostat is set to single stage heat / single stage cool mode. When a cool call is given, 24VAC should be applied to the Y terminal (G will have 24VAC as well if a G wire is installed). When a heat call is given 24VAC should be applied to the W terminal (G may have 24VAC as well if a G wire is installed). Even if a heat pump is installed, do not setup the thermostat in heat pump mode. Single stage heat / single stage cool mode is all that is required for all applications. See rest of manual for any exceptions. Do not setup thermostat in multi stage mode either, it is not necessary.
- 3) For communicating 2 stage AC/HP or inverter AC/HP outdoor units, connect the 1&2 wires between the indoor and outdoor unit. It is recommended for 2 stage applications that a separate transformer be installed in the outdoor unit to provide 24VAC to the outdoor control. R&C can be used between the indoor and outdoor in 2 stage AC application but only if there isn't already a transformer installed in the outdoor unit.
- 4) Turn on power to Indoor and Outdoor units
- 5) Charging outdoor unit: Provide a cooling call (Y or Y+G) – this initial cooling call after the power is turned on will run the outdoor unit at full capacity until the call is removed. Use this mode for charging. If system is running low stage cooling just cycle power and provide a cool call again to ensure full capacity cooling.
- 6) System Testing: Download the CoolCloudHVAC phone application (see pages 31 and 32) and use it to test all operations of both indoor and outdoor units.
- 7) Confirm thermostat heat (W or W+G) and cool (Y or Y+G) function properly and the system is turning on in the correct mode. The internal algorithms will constantly be adjusting the staging times / cooling capacities based on load changes to the space.

NOTE: If a heat pump is installed it will be treated as a priority heat for a W call. To test gas heat only, without waiting for the system to stage between the heat pump and furnace, disconnect communications between the indoor and outdoor unit before running the heating test.

Control System – General Information

The furnace contains internal logic to control equipment staging. An adjustable target runtime is available (range from 1 to 240 minutes) and set through the appropriate system menu. The system will constantly be adjusting staging in an effort to satisfy the thermostat call for cooling (Y only) or heating (W Only) as close to the set target runtime as possible. See information below for setting options.

Comfort Setting Menu (CFS): There are 6 options available in the Comfort Setting Menu which impacts both the System Target Runtime and Dual Fuel Operation. Dual Fuel operation adjustments only apply if a communicating heat pump is installed. Comfort Setting Options 1 – 5 have set values for the System Target Runtime and option 6 enables additional menus to customize all comfort settings. See list below for the System Target Runtimes associated with the first 5 Comfort Settings. These first 5 options are setup to help satisfy the thermostat slower or faster based on the selection where option 1, with a 10 minute Target Runtime, is attempting to satisfy much faster than option 5, with a 30 minute Target Runtime.

System Target Runtime:

- Comfort Setting Option 1) 10 Minute System Target Runtime**
- Comfort Setting Option 2) 15 Minute System Target Runtime**
- Comfort Setting Option 3) 20 Minute System Target Runtime**
- Comfort Setting Option 4) 25 Minute System Target Runtime**
- Comfort Setting Option 5) 30 Minute System Target Runtime**

Dual Fuel Adjustment: This system will automatically determine if the heat pump is capable of satisfying the thermostat in the selected System Target Runtime. If the heat pump is unable to satisfy in the selected time, dual fuel settings will determine how many attempts should be given to the heat pump before temporarily locking it out and using the furnace. These dual fuel settings also determine at what time the system should remove the temporary heat pump lockout and run the heat pump again.

There are four adjustable items associated with Dual Fuel control. In the same way as the System Target Time, each of these items have defaulted values for Comfort Settings 1 – 5. Only when Comfort Setting 6 is selected will each item be available for full adjustment.

- 1) **Stage Up Percent (7 segment menu SUP):** This is a value that determines how far past the target runtime the system should continue running the heat pump before transitioning to the furnace. For example, assume this menu was set to 20% with a target runtime of 20 minutes. If the thermostat did not remove the heating call after 20 minutes, the system would allow for an additional 20% heat pump run (20% of the 20 minute target is an additional 4 minutes). In this case, the system would transition to gas heat after 24 minutes if the thermostat call was still present. Each time this occurs, the system records this as a strike against the heat pump (the strike is important when looking at the Over Target Threshold)

SYSTEM OPERATION

- 2) **Over Target Threshold (7 segment menu Ott):** If the heat pump has consecutively transitioned to gas heat for the selected Over Target Threshold amount of times, meaning for this many consecutive cycles it has been unable to satisfy the target time by itself, then the heat pump will be temporarily locked out and the furnace will become the primary heat source.
- 3) **Stage Down Percent (7 segment menu SdP):** This only applies when the heat pump is in a temporary lockout condition. In this case, the system will be trying to determine when the best time is to remove the lockout and run the heat pump again. To determine the best time to remove the heat pump lockout the system looks at how easily the furnace is able to satisfy the thermostat using Low Stage Gas Heat Only. Assume this setting is 15% and the target time is 20 minutes. If Low Stage Gas Heat can satisfy the thermostat in less than 17 minutes (20 minutes - 15% = 17 minutes) then the algorithm records a strike against the gas furnace. (this strike is important when looking at the Under Target Threshold).
- 4) **Under Target Threshold (7 segment menu Utt):** If the furnace is able to satisfy the thermostat using Low Stage Gas Heat Only for the selected number of consecutive cycles the heat pump lockout will be temporarily removed. The heat pump will then be used during the next cycle. If the heat pump can satisfy the thermostat in less than the System Target Runtime the temporary heat pump hold will be completely removed and the heat pump will become the primary heat source again. if it fails to do so, the strike count against the furnace will be reset and the furnace will remain the temporary primary heat source until the Under Target Threshold is reached again.

The system will automatically make adjustments in an attempt to satisfy the thermostat as close to this target runtime as possible. After a power cycle or mode change (cooling to heating or heating to cooling) the system will run full capacity for the selected mode during the first thermostat call. Based on the selected target runtime and how long the initial cycle takes to satisfy the thermostat, the control algorithm will adjust the system stage times for a 2 stage unit or the capacity demand percentage for an inverter / modulating unit for the next cycle. Note: actual runtimes may change depending on variations of load throughout the day.

The following table shows the default values for all Comfort Setting Options (1 - 5)

| Comfort Setting Option | Target Time (Minutes) | Stage Up Percentage (%) | Stage Down Percentage (%) | Over Target Threshold (Strike Count) | Under Target Threshold (Strike Count) |
|------------------------|-----------------------|-------------------------|---------------------------|--------------------------------------|---------------------------------------|
| 1 | 10 | 20 | 20 | 2 | 10 |
| 2 | 15 | 20 | 20 | 4 | 8 |
| 3 | 20 | 20 | 20 | 6 | 6 |
| 4 | 25 | 20 | 20 | 8 | 4 |
| 5 | 30 | 20 | 20 | 10 | 2 |

The following table shows the ranges for each of item when the adjustable Comfort Setting Option 6 is selected. The table shows the minimum value, the maximum value and the defaulted value. All items can be adjusted up or down by increments of 1 which provides full flexibility for all items. Note: it is critical that these numbers be set properly. If Comfort Setting option 3 is desired but a target time of 60 is preferred, select Comfort Setting Option 6 to enable all the adjustable menus, set the Target Time to 60 and make sure the other menus are set to match that of Comfort Setting Option 3.

| Menu | Minimum Value | Maximum Value | Default Value |
|------------------------------|---------------|---------------|---------------|
| Target Time (t9t) | 1 minute | 240 minutes | 60 minutes |
| Stage Up Percent (SUP) | 0% | 100% | 20% |
| Stage Down Percent (SdP) | 0% | 100% | 20% |
| Over Target Threshold (Ott) | 1 strike | 254 strikes | 20 strikes |
| Under Target Threshold (Utt) | 1 strike | 254 strikes | 20 strikes |

CIRCULATOR BLOWER SPEED

The Airflow quantity is displayed as a number on the three 7 segment displays, rounded to the nearest 100 CFM. The display alternates airflow amount and the system operating status.

Each furnace has a “Maximum CFM” it is capable of providing. All fan operations (Constant CFM, Cooling Airflow Profiles, Low and High Stage gas heat airflow, outdoor Air Conditioner / Heat Pump Airflow, etc.) are based off of multipliers which are percentages of this maximum CFM. Max CFM is as follows:

- 3 Ton Models 1400 CFM
- 4 Ton Models 1760 CFM
- 5 Ton Models 2200 CFM

Setup Furnace Airflow: adjust the Gas Heating Airflow menu (gAF) setting to the desired percentage of maximum airflow. In most cases the default gas heat airflow will provide a temperature rise near the middle of the acceptable range. High Stage CFM can be calculated by the following equation: CFM = Max CFM * Selected Heating Airflow Percentage.

For Communicating Outdoor Units: Main airflow adjustment is not required. The Outdoor unit will determine the appropriate amount of indoor airflow to request. Airflow Trims can be made if desired.

For Non-Communicating outdoor units, determine the proper airflow (based off tonnage of) the outdoor unit. Most cooling systems are designed to work with airflow

SYSTEM OPERATION

between 350 and 450 CFM per ton. 400 CFM/TON is the industry standard. Once desired airflow has been determined, see Tonnage / Airflow table to identify the Tonnage Selection that is closest to the desired airflow. This table is based on 400 CFM per ton where Airflow = (400 CFM) x (Selected Tonnage).

Example: if 1520 CFM is the desired airflow the Tonnage Selection that matches this is 3.8

Enter the Tonnage (ton) menu either by using the on board push buttons or phone application and select the Tonnage Selection you identified. Note: Trim is also available if additional adjustment is required.

| Tonnage Selection | Airflow | Tonnage Selection | Airflow | Tonnage Selection | Airflow | Tonnage Selection | Airflow |
|-------------------|---------|-------------------|---------|-------------------|---------|-------------------|---------|
| 1 | 400 | 2.3 | 920 | 3.6 | 1440 | 4.9 | 1960 |
| 1.1 | 440 | 2.4 | 960 | 3.7 | 1480 | 5 | 2000 |
| 1.2 | 480 | 2.5 | 1000 | 3.8 | 1520 | 5.1 | 2040 |
| 1.3 | 520 | 2.6 | 1040 | 3.9 | 1560 | 5.2 | 2080 |
| 1.4 | 560 | 2.7 | 1080 | 4 | 1600 | 5.3 | 2120 |
| 1.5 | 600 | 2.8 | 1120 | 4.1 | 1640 | 5.4 | 2160 |
| 1.6 | 640 | 2.9 | 1160 | 4.2 | 1680 | 5.5 | 2200 |
| 1.7 | 680 | 3 | 1200 | 4.3 | 1720 | 5.6 | 2240 |
| 1.8 | 720 | 3.1 | 1240 | 4.4 | 1760 | 5.7 | 2280 |
| 1.9 | 760 | 3.2 | 1280 | 4.5 | 1800 | 5.8 | 2320 |
| 2 | 800 | 3.3 | 1320 | 4.6 | 1840 | 5.9 | 2360 |
| 2.1 | 840 | 3.4 | 1360 | 4.7 | 1880 | 6 | 2400 |
| 2.2 | 880 | 3.5 | 1400 | 4.8 | 1920 | | |

COOLING AIRFLOW RAMPING PROFILES

The multi-circulator blower also offers several custom ON/ OFF ramping profiles. These profiles may be used to enhance cooling performance and increase comfort level. The ramping profiles are selected using the Cooling Airflow Profile menu (if push buttons are used, use the CAP menu to select the desired profile). Refer to the bullet points below for a description of each ramping profile.

- Profile A(1) provides only an OFF delay of one (1) minute at 100% of the cooling demand

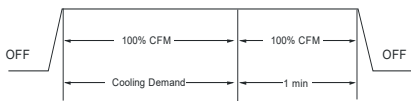

- Profile B(2) ramps up to full cooling demand airflow by first stepping up to 50% of the full demand for 30 seconds. The motor then ramps to 100% of the required airflow. A one (1) minute OFF delay at 100% of the cooling airflow is provided.

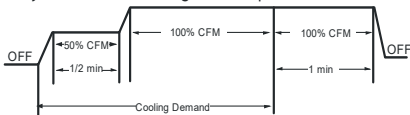

- Profile C(3) ramps up to 85% of the full cooling demand airflow and operates there for approximately 7 1/2 minutes. The motor then steps up to the full demand airflow. Profile C also has a one (1) minute 100% OFF delay.

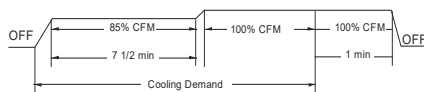

- Profile D(4 or 5) ramps up to 50% of the demand for 1/2 minute, then ramps to 85% of the full cooling demand airflow and operates there for approximately 7 1/2 minutes. The motor then steps up to the full demand airflow. Profile D has a 1/2 minute at 50% airflow OFF delay.

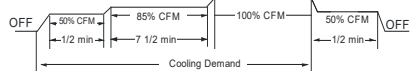

In general lower heating speeds will: reduce electrical consumption, lower operating sound levels of the blower, and increase the outlet air temperature delivered to the home if heatmode is running. If cooling mode is running the same airflow adjustment will decrease the outlet air temperature delivered to the home. The speeds available allow the blower performance to be optimized for the particular homeowner's needs.

LOW VOLTAGE WIRING - GENERAL INFORMATION

The Furnace functions with any thermostat that can be configured to provide 24VAC on Y for cooling calls and 24VAC on W for Heating calls. Based on these simple inputs, internal algorithms will decide how to control two stages of furnace heat in addition to any single or multi stage outdoor heating / cooling operation (the algorithms will handle dual fuel multi-stage systems as well). The thermostat must be setup to provide only a Y call when cooling is required and only a W call when heating is required. This is generally accomplished by selecting single stage heat / single stage cool mode during setup (if setup is required). Do not set thermostat to heat pump operation as system will not operate properly.

Note: The only exception is if a single stage non-communicating Heat Pump is connected to the furnace. Refer to Non-Communicating Single Stage Heat Pump diagram for details.

Thermostat connections to the control board are R, C, G, W, Y & Dehum. Provided the thermostat does not require a common wire as few as two thermostat wires may be used for heat only (R and W) or cool only (R and Y) systems. A minimum three thermostat wires may be used for heating and cooling systems (R, W and Y). Refer to thermostat wiring diagrams below for your system configuration.

Low voltage connections can be made through either the right or left side panel of the furnace. Thermostat wiring entrance holes are located in the blower compartment.

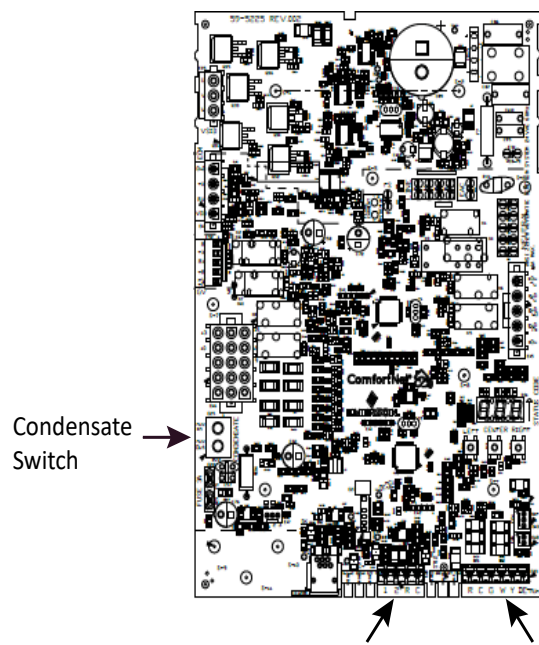

Figure 35

MAIN CONTROL BOARD

SYSTEM OPERATION

For gas heat only operations (no outdoor unit installed) the thermostat must be setup to provide a single stage W call when heating is required. See Gas Heat Only wiring diagram for wiring instructions.

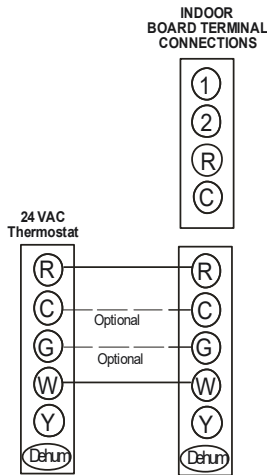

Figure 36

GAS HEAT ONLY

LOW VOLTAGE WIRING - COMMUNICATING OUTDOOR UNIT

Internal logic will control staging of all multi stage equipment (2 stage AC/HP units and Inverter AC/HP units). The thermostat is only required to provide a single stage heat / cool call and fan or dehumidification call during operation.

Two wires are required between the indoor unit and outdoor unit on the 1 and 2 terminals. It is recommended to install a separate transformer with all 2 stage outdoor units to reduce the power draw on the indoor transformer.

4 wires (R,C for power and 1, 2 for communications) can be used for AC applications. See wiring images for details.

Do not connect R & C between the indoor unit and the outdoor unit if there is already a transformer installed in the outdoor unit providing 24VAC to the outdoor control. In this case, just use 1 and 2 terminals for communications

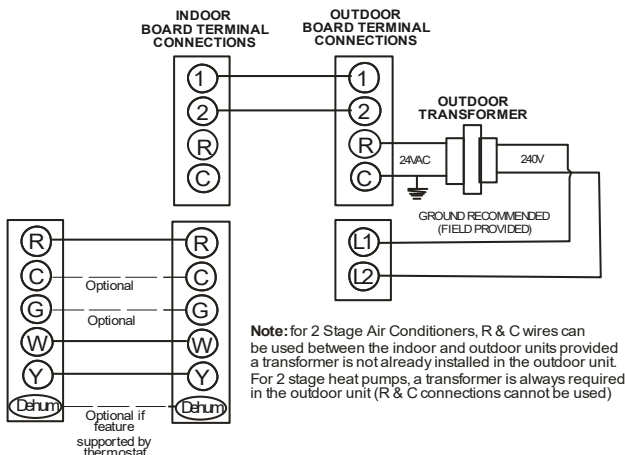

Figure 37

COMMUNICATING TWO STAGE AIR CONDITIONER OR HEAT PUMP

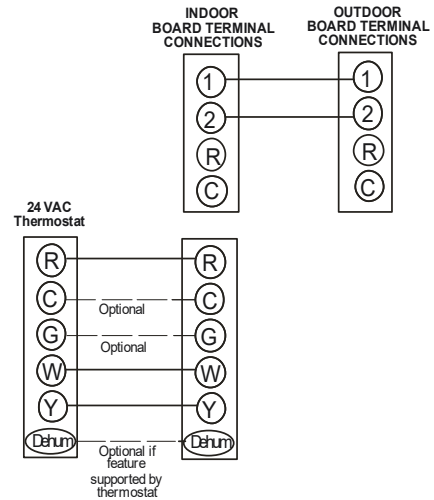

Figure 38

COMMUNICATING INVERTER AIR CONDITIONER OR HEAT PUMP

LOW VOLTAGE WIRING - NON-COMMUNICATING OUTDOOR UNIT

When using the furnace with a single stage non-communicating air conditioner or heat pump use the wiring methods shown. When using a single stage air conditioner, the thermostat must be setup for single stage heating and single stage cooling mode. When using a single stage heat pump, the thermostat must be setup for dual fuel operation where the reversing valve is energized in cooling mode (see Non-Communicating Single Stage Heat Pump wiring diagram). In both cases airflow must be selected using the tonnage menu where Airflow = (400 CFM) x (Selected Tonnage). Tonnage values range from 1 to 6 in 0.1 increments.

NOTE: Airflow will not go above the system Max CFM. If the tonnage value selected generates an airflow value above the Max CFM, the system will cap this value and not provide any more airflow than the Max CFM.

SYSTEM OPERATION

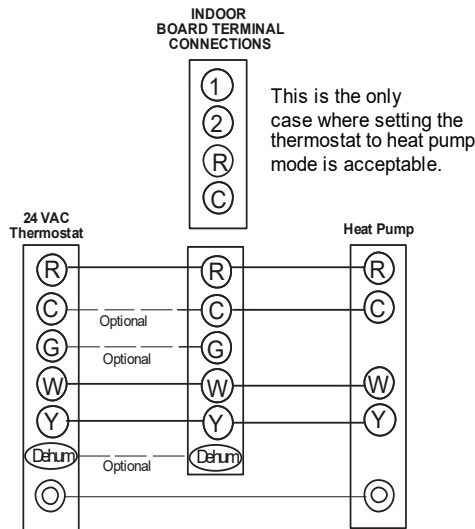

Figure 39

NON-COMMUNICATING SINGLE STAGE HEAT PUMP

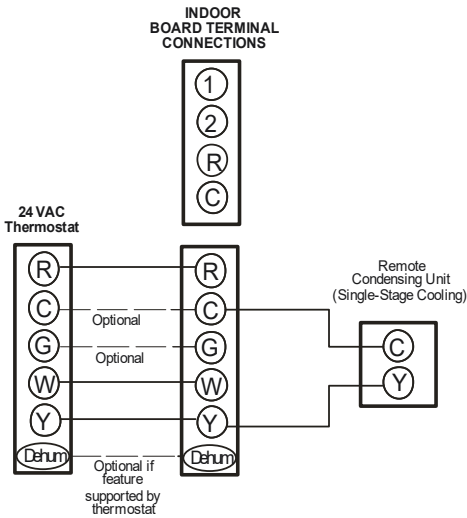

Figure 40

NON-COMMUNICATING SINGLE STAGE A/C

DEHUMIDIFICATION

The control board is equipped with a 24 volt dehum input in the thermostat wiring connector to be used with a thermostat or dehumidistat. Dehumidification mode allows the air handler's circulator blower to operate at a slightly lower speed (85% of calculated speed) during a combined thermostat call for cooling and thermostat call for dehumidification or dehumidistat call for dehumidification. This lower blower speed enhances dehumidification of the conditioned air as it passes through the AC coil. If using the dehum input with a thermostat, configure the thermostat to energize this terminal when dehumidification is desired. If using an external dehumidistat, connect it between the R and Dehum terminals. The dehumidistat must operate on 24 VAC and utilize a switch which *closes on humidity rise*. Refer to the low voltage wiring diagrams for additional wiring details.

Dehumidistat (close on humidity rise)

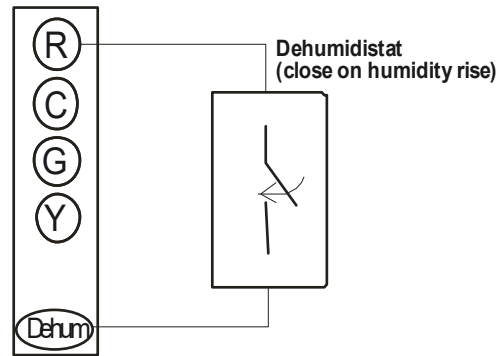

Figure 41

SYSTEM OPERATION

Dehumidification Control Options

Key Mitigations:

1. Full featured TS (dehum & overcool)
2. Connect G and dehum wire correctly
3. Dehumidistat

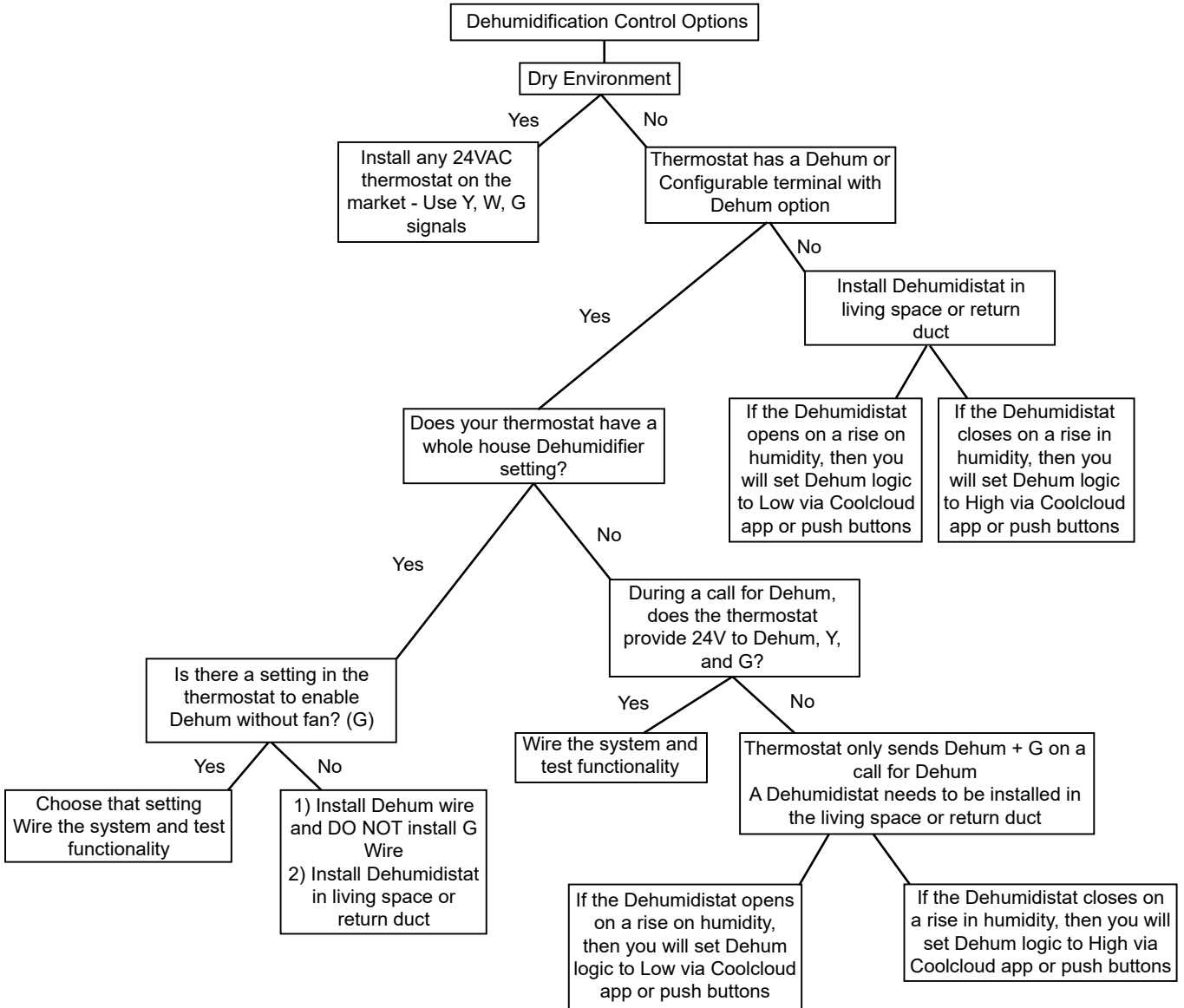

SYSTEM OPERATION

FOSSIL FUEL APPLICATIONS

This furnace can be used in conjunction with a heat pump in a fossil fuel application. A fossil fuel application refers to a combined gas furnace and heat pump installation which uses an outdoor temperature sensor to determine when to run the heat pump or gas furnace.

For non-communicating single stage heat pump installations a fossil fuel kit can be used. Follow the wiring guidelines in the fossil fuel kit installation instructions. All furnace connections must be made to the furnace integrated control module and the "FURNACE" terminal strip on the fossil fuel control board.

For Fossil Fuel systems the heat pump is given priority when a compressor balance point lockout condition is not present. Transitions from primary heat pump heating to backup gas heating will result in full capacity operation during the first thermostat call. The furnace PCB algorithms will then continuously adjust the stage times or the percent capacity after the initial call in an attempt to satisfy the thermostat at the target runtime.

Automatic Fossil Fuel Adjustment: If both compressor balance point and backup heat balance point lockouts are not present, the furnace algorithms will determine if the heat pump is capable of satisfying the thermostat in the selected target runtime. If the heat pump is not capable of this it will be locked out until the furnace can satisfy the thermostat, under the target runtime, while running completely in low stage. At that point, an attempt will be given to the heat pump and a decision made to keep using gas heat or to transition back to the heat pump.

115 VOLT LINE CONNECTION OF ELECTRONIC AIR CLEANER



WARNING



HIGH VOLTAGE !

TO AVOID PERSONAL INJURY OR DEATH DUE TO ELECTRICAL SHOCK, DISCONNECT ELECTRICAL POWER BEFORE SERVICING OR CHANGING ANY ELECTRICAL WIRING.

The accessory load specifications are as follows:

| | |
|-----|----------------------------|
| EAC | 1.0 Amp maximum at 120 VAC |
|-----|----------------------------|

The furnace integrated control module is equipped with a line voltage accessory terminal for controlling power to an optional field supplied electronic air cleaner or any device required to operate in parallel with a circulating fan demand.

To connect an electronic air cleaner using the line voltage EAC terminal:

- Turn OFF power to the furnace before installing any accessories.

- Follow the air cleaner manufacturers' instructions for locating, mounting, grounding, and controlling accessories. Utilize 1/4" quick connect terminals to make accessory wiring connections to the furnace integrated control module.
- Connect the hot terminal utilized for accessory operation to the EAC terminal and the neutral side of power to NEUTRAL bus on the integrated furnace control or the neutral connection in the furnace junction box.
- All field wiring must conform to applicable codes.
- Connections should be made as shown.
- If it is necessary for the installer to supply additional line voltage wiring to the inside of the furnace, the wiring must conform to all local codes, and have a minimum temperature rating of 105°C.
- All line voltage wire splices must be made inside the furnace junction box.

AUXILIARY ALARM SWITCH:

The control is equipped with a 24VAC Aux Alarm to be used for a condensate switch install (designated by "Condensate" on the control). These contacts could also be used with compatible CO₂ sensors or Fire Alarms. By default, an AUX switch is normally closed and opens when the water level in the evaporator coil base pan reaches an undesirable level. The control will respond by turning off the outdoor condensing unit and display EEd. If the AUX switch is detected closed for 30 seconds, normal operation resumes and error messages are no longer displayed.

CoolCloudHVAC Phone Application - General Information

Examples of CoolCloudHVAC Phone Application Screens

NOTE: Actual screen may look different based on the device being used.

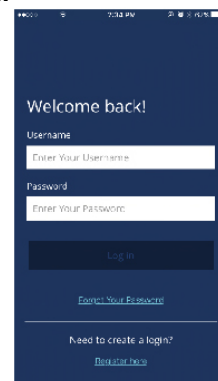

SYSTEM OPERATION

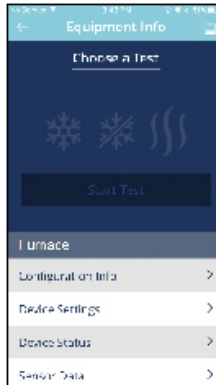
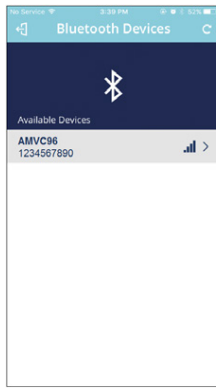

This furnace is Bluetooth ready and functions with a custom phone application designed to improve the setup / diagnostic experience of the installing contractor. Users can see specific model information, review active diagnostic error codes, observe system status during operation, make system menu adjustments such as the target runtime, add site visit notes and run system testing of all operational modes (heat / cool / fan) directly from the phone. The phone application is also capable of directly updating the furnace software anytime updates are available (the application will automatically notify the user if updates are available). Software update time could take approximately 15 minutes to complete. The phone must remain within Bluetooth range for only the download step of an update. The user will be notified once the download is completed and installation begins. At this time the phone can be removed from the Bluetooth range if necessary (Note: if the phone is out of range, the user will not know when the installation has completed or what the existing status of the installation is). Download the CoolCloud Phone Application and create an account to get started. A Wi-Fi/Cellular connection will be required for account setup.

Connecting Phone Application to Furnace

When in close proximity to the furnace, the phone application will detect the Bluetooth Network being broadcasted by the system. Once the Bluetooth network is selected by the user, due to security reasons, the user will be prompted for a 3 digit access code be-

fore system information can be displayed. The 3 digit code will be displayed on the three seven segment displays of the furnace control board. A sightglass is located close to the control board that can be used to see these digits. The user must enter the access code into the phone application when prompted to do so in order to gain access to system information. 3 failed entry attempts will result in a new code being displayed on the control. If all 3 digits are not visible from the sight glass, the user has two options to connect.

Option 1) Perform thermostat task as instructed by the phone application to gain access. The following steps will explain what this task involves.

- **Step 1**, ensure the thermostat is in an idle state (no cool, heat or fan calls). To do this, set the thermostat fan mode to Auto (not ON) and then remove any active heat / cool calls. This task needs to be completed within 5 minutes of the process beginning.
- **Step 2**, provide any 24VAC call to the control from the thermostat (cooling, heating or fan will work). This task must occur within 8 minutes after the Step 1 is complete.
- **Step 3**, remove the call that was provided during Step 2. This task must be completed within 1 minute after the call is provided during Step 2.

If the phone remains within Bluetooth range during the three steps, the user will be notified when each step has been completed and informed about what to do next. If the user is not within Bluetooth range during this process the phone application will still provide instruction about what tasks to complete. After all 3 steps have successfully been completed, the user will have access to system information once in range.

Option 2) Remove the furnace door, ensure the control has power and then read the 3 digits. The code will temporarily remain active after a power cycle so the door can be put back on before making the connection if desirable. Note: power will be cycled to the control board with this option. If it is not desirable to cycle power to the unit for diagnostic purposes Option 1 may be a better method to connect.

At power-up, the furnace control will display the unit address (a two digit number) on the 2nd and 3rd characters of the three seven segment displays. After the furnace control has completed its' internal start-up routine, the furnace control will display the Status Menu.

The control board will display "Id L" while in idle (stand-by) mode waiting for a call from the thermostat. The furnace control is now ready to receive inputs from the room thermostat.

SYSTEM OPERATION

The furnace control board will detect any compatible communicating outdoor unit connected to it. Items that appear in the main menu will vary accordingly. Example, you will not see heat pump specific menus unless a compatible heat pump is detected by the furnace control.

Push Button Switches



Three push-button switches on the control board may be used to navigate menus and select options. The three switches are labeled Left, Center and Right. The center switch is used to enter into the option menu and make the selection, the left and right switches are used to browse the main menu and option menus. When the center switch is pressed in the main menu, the furnace control will go to the option menu and display the default or previously-selected option. Pressing the left or right button will display the next available option. When the next adjustable or selectable option is displayed, the furnace control will flash the option with 1/2 second ON and 1/2 second OFF indicating the option has not yet been selected. To select an option; press and release the center button to stop the current option from flashing. When the option has stopped flashing, press the center button again to select that option.

While navigating through options; if no switches are pressed during a 30 second time period, the display will time-out and return to the Status Menu. Simultaneously pressing & releasing any two switches will also return the furnace control back to the Status Menu. If the previously displayed option was not selected and a timeout occurs, the displayed option will not be stored in control memory as a selected option.

The Status Menu includes the following items;

- The operation mode
- Blower CFM (if blower is running)
- Humidification/Dehumidification mode (if active)
- Ventilator operation (if active)
- any active fault codes

Menu items will appear in rotation as follows:

- Each item is ON for 2 seconds
- OFF for 1 second
- Then to the next item

Example of Menu Navigation & Option Change

This is an example for how to use the push buttons to make a change to the constant fan speed.

COOL CLOUD HVAC PHONE APPLICATION

- 1) When looking at the Furnace Control, the three 7 Segment displays (located just above the push buttons) will be displaying system status. System status includes the current modes of operation, airflow and any active error codes.

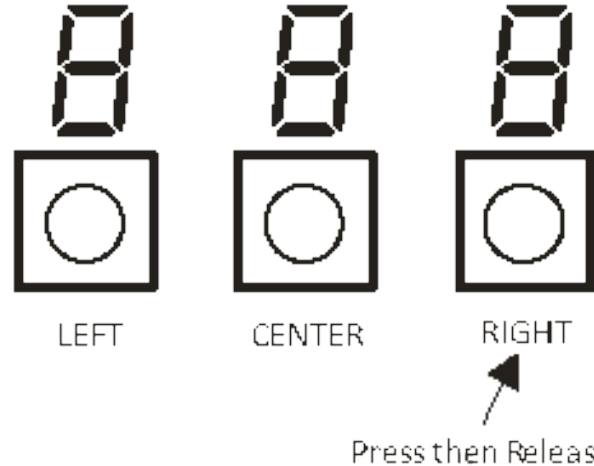

- 2) Press and release the Right Button (this will cycle through the menus in one direction. Pressing the Left Button would cycle through the menus in the opposite direction. For this example, the right button will be used).
- 3) The screen will now display Menu L6F (Last 6 Faults). Continue pressing and releasing the Right Button until you see FSd which is the menu for Constant Fan Multiplier. Before reaching the FSd menu you will scroll through Menus L6F, Lm, Cr, Sr and rFd.

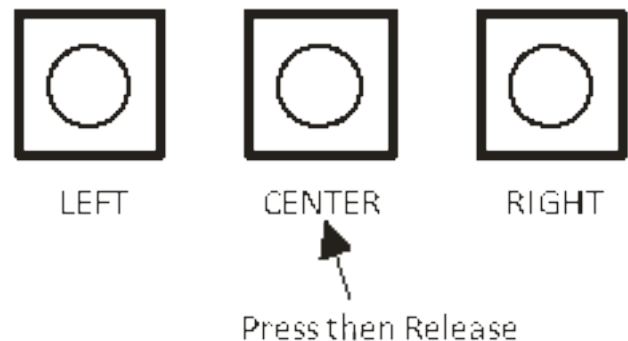

- 4) Press and release the Center Button. The center button is used to enter menus and make selections within menus.
- 5) What will be displayed is the currently selected fan only percentage. For this example the assumption is that this currently selected fan only percentage is 25% and changing this to 45% is the objective.
- 6) Press and Release the Right button. The screen will change to 35 and start flashing. The flashing indicates the displayed option has not been selected yet.

SYSTEM OPERATION

- 7) Press and Release the Right button again. The 7 segment displays will continue flashing but will now display 45.

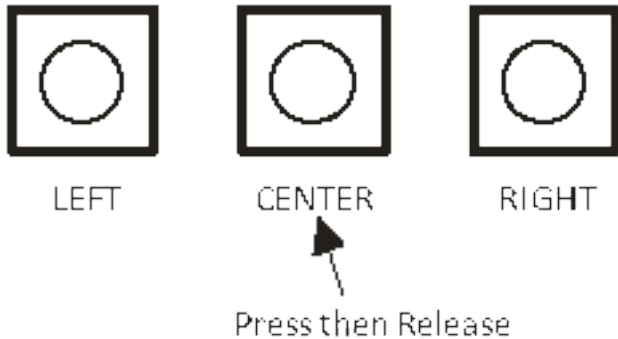

- 8) Press and Release the Center Button again. The 45 being displayed will stop flashing. To then complete the selection process and make 45 the official fan only setting Press and Release the Center Button for the last time. This final step will jump the user back to the main menu list and FSd will be displayed again.
- 9) The constant fan multiplier has now been changed from 25 to 45

Airflow Display

When the blower is running the CFM will be displayed in Status Menu. The first 7 segment character will display "A". The second & third characters will display the actual CFM divided by 100. The actual CFM will display rounded up or down to the nearest 100 CFM as follows;

- 550 to 649 CFM display as "A06"
- 1150 to 1249 CFM display as "A12"

Alarm Display

If an active alarm is present, the alarm code shall be reported in Status Menu starting with "E" and following with the appropriate two digit alarm code.

Clearing Faults

While in the Last 6 Faults option menu, push & hold the center button for 5 seconds. This will clear all non-active alarm(s) in the Last 6 Faults menu. The display will flash three times to confirm faults have been cleared.

Learn Menu

Using this option resets the communicating network which will cause the furnace to discover what devices are present on ClimateTalk™ network. This menu will not appear when the furnace control is connected to a Non-Comm OD unit.

Code Release Number Menu

This is a reference only menu to display the firmware release revision numbers for each micro-controller.

Constant Fan Speed Menu

This menu allows for adjustment of the multiplier for constant fan operation in 10% increments. Each furnace has a "Maximum CFM" determined by motor HP. All fan operations are based off of multipliers which are percentages of this number. Max CFM is shown below. The default constant fan multiplier is 25%.

| Model | Max CFM |
|--------------|---------|
| 3 Ton Models | 1400 |
| 4 Ton Models | 1760 |
| 5 Ton Models | 2200 |

Gas Heat Airflow Multiplier Menu

The menu is used to change the gas heat airflow multiplier for gas heat operation. In most cases the default gas heat airflow will provide a temperature rise near the middle of the acceptable range. The multiplier will be expressed by the 2nd & 3rd characters of the display as a percentage of max CFM.

Gas Heat Fan Off Delay Menu

The default setting is 90 seconds. The available adjustment range is from 30 to 180 seconds in 30 second increments.

Gas Heat Fan On Delay Menu

The default setting is 30 seconds. The available adjustment range is from 5 to 30 seconds in 5 second increments.

Gas Heat Trim Factor Option Menu

Gas Heat airflow may be trimmed from -10% to +10% in 2% increments.

Gas Heat Stage Multiplier Menu (CFM)

This menu allows adjustment of the low fire CFM multiplier. The default CFM for low fire is 70% of high fire.

Gas Pressure Test Menu

This menu allows 100% firing rate be locked in to check gas valve pressure.

CAUTION

TO PREVENT UNRELIABLE OPERATION OR EQUIPMENT DAMAGE, THE INLET GAS SUPPLY PRESSURE MUST BE AS SPECIFIED ON THE UNIT RATING PLATE WITH ALL OTHER HOUSEHOLD GAS FIRED APPLIANCES OPERATING.

SYSTEM OPERATION

| INLET GAS SUPPLY PRESSURE | | |
|---------------------------|---------------------|---------------------|
| Natural Gas | Minimum: 4.5" w.c. | Maximum: 10.0" w.c. |
| Propane Gas | Minimum: 11.0" w.c. | Maximum: 13.0" w.c. |

NORMAL SEQUENCE OF OPERATION

POWER UP

- 120 VAC power applied to furnace.
- Integrated ignition control performs internal checks.
- The control board will display I D L. awaiting a call from the thermostat
- Integrated ignition control monitors safety circuit continuously.
- Furnace awaits call from thermostat.

HEATING MODE

The normal operational sequence in heating mode is as follows:

- R and W thermostat contacts close, initiating a call for heat.
- Integrated control module performs safety circuit checks.
- **Pressure Sensor Verification:** The control operates the inducer in a manner to verify the pressure sensor null value and span operation are within specification. If the system is operating correctly, this test takes only a few seconds. If the system is not functioning properly, the control times out after a maximum 90 seconds and display the proper fault code.
- Induced draft blower is energized for 30 second prepurge.
- Igniter warm up begins after 30 second prepurge expires.
- Gas valves open at end of igniter warm up period, delivering gas to burners and establishing flame.
- Integrated control module monitors flame presence. Gas valve will remain open only if flame is detected.
- Circulator blower is energized on high heat speed following a fixed 30 second blower on delay. Electronic air cleaner terminal is energized with circulator blower.
- Furnace operates; integrated control module monitors safety circuits continuously.
- R and W thermostat contacts open, completing the call for heat.
- Gas valve closes, extinguishing flame.
- Induced draft blower is de-energized following a thirty second post purge.
- Circulator blower continues running for selected heat off delay period factory set at 120 seconds. If required this can be changed in the field.
- Electronic air cleaner is de-energized.
- Furnace awaits the next call from thermostat.

COOLING MODE

The normal operational sequence in cooling mode is as follows:

- R, Y and G thermostat contacts close, initiating a call for cool.
- Integrated control module performs safety circuit checks.
- Outdoor fan and compressor are energized.
- Circulator blower is energized on cool speed following a fixed six second on delay. If required this can be changed in the field to 45 seconds. Electronic air cleaner terminal is energized with circulator blower.
- Furnace circulator blower and outdoor cooling unit run, integrated control module monitors safety circuits continuously.
- R, Y and G thermostat contacts open, completing the call for cool.
- Outdoor fan and compressor are de-energized.
- Circulator blower is de-energized following a fixed forty five second cool off delay period. Electronic air cleaner terminal is de-energized.
- Furnace awaits the next call from thermostat.

FAN ONLY MODE

The normal operational sequence in Fan Only Mode is as follows:

- R and G thermostat contacts close, initiating a call for fan.
- Integrated control module performs safety circuit checks.
- Circulator blower is energized on low heat speed. Electronic air cleaner terminal is energized.
- Circulator blower runs, integrated control module monitors safety circuits continuously.



Combustion Quality

Combustion quality can be affected by several factors. Major factors are venting and draining.

Other Causes

1. Manifold Gas Pressure must be set within the range stated on the furnace rating plate.
2. Remove Draft Inducer, Check the integrity of the gasket between the inducer and the collector box cover, any air leak here will have a negative effect on combustion. Check the orifice hole in the collector box, it must be free of burrs on both sides.
3. Make sure the field installed gas line is not binding and causing distortion of burner assembly
4. Make sure there are no cabinet air leaks allowing supply air to affect combustion
5. If heat exchanger integrity is uncertain, follow procedures in Service Bulletin SF-041

SCHEDULED MAINTENANCE

| | |
|--|---|
|  WARNING |  |
| HIGH VOLTAGE DISCONNECT ALL POWER BEFORE SERVICING OR INSTALLING THIS UNIT. MULTIPLE POWER SOURCES MAY BE PRESENT. FAILURE TO DO SO MAY CAUSE PROPERTY DAMAGE, PERSONAL INJURY OR DEATH. | |

| |
|--|
|  CAUTION |
| IF YOU MUST HANDLE THE IGNITOR, HANDLE WITH CARE. TOUCHING THE IGNITOR BODY WITH BARE FINGERS, ROUGH HANDLING, OR VIBRATION COULD RESULT IN EARLY IGNITOR FAILURE. ONLY A QUALIFIED SERVICER SHOULD EVER HANDLE THE IGNITOR. |

ANNUAL INSPECTION

The furnace should be inspected by a qualified installer, or service agency at least once per year. This check should be performed at the beginning of the heating season. This will ensure that all furnace components are in proper working order and that the heating system functions appropriately. Pay particular attention to the following items. Repair or service as necessary.



- Flue pipe system. Check for blockage and/or leakage. Check the outside termination and the connections at and internal to the furnace.
- Heat exchanger. Check for corrosion and/or buildup within the heat exchanger passageways.
- Burners. Check for proper ignition and flame sense.
- Wiring. Verify that electrical connections are tight and free from corrosion.
- Filters.

AIR FILTER

| |
|---|
|  WARNING |
| NEVER OPERATE FURNACE WITHOUT A FILTER INSTALLED AS DUST AND LINT WILL BUILD UP ON INTERNAL PARTS RESULTING IN LOSS OF EFFICIENCY, EQUIPMENT DAMAGE, AND POSSIBLE FIRE. |

Filters must be used with this furnace. Filters do not ship with these furnaces but must be provided by the installer for proper furnace operation.

Dirty filters are the most common cause of inadequate heating or cooling performance.

| | |
|---|---|
|  WARNING |  |
| HIGH VOLTAGE DISCONNECT ALL POWER BEFORE SERVICING, REMOVING THE FILTER OR PERFORMING ANY OTHER MAINTENANCE. MULTIPLE POWER SOURCES MAY BE PRESENT. FAILURE TO DO SO MAY CAUSE PROPERTY DAMAGE, PERSONAL INJURY OR DEATH. | |

Maintenance

Improper filter maintenance is the most common cause of inadequate heating or cooling performance. Filters should

be cleaned (permanent) or replaced (disposable) every two months or as required.

Horizontal Unit Filter Removal

Filters in horizontal installations are located in the central return register.

INDUCED DRAFT AND CIRCULATION BLOWERS

The bearings in the induced draft blower and circulator blower motors are permanently lubricated by the manufacturer. No further lubrication is required. Check motor windings for accumulation of dust which may cause overheating. Clean as necessary.

FLAME SENSOR (QUALIFIED SERVICER ONLY)

Under some conditions, the fuel or air supply can create a nearly invisible coating on the flame sensor. This coating acts as an insulator, causing a drop in the flame sensing signal. If this occurs, a qualified servicer must carefully clean the flame sensor with steel wool. After cleaning, the flame sensor output should be as listed on the specification sheet.

The following is a must for every service technician and service shop.

1. Dial type thermometers or thermocouple meter (optional) - to measure dry bulb temperature.
2. Amprobe - to measure amperage and voltage.
3. Volt-Ohm Meter - testing continuity, capacitors, and motor windings.
4. Inclined Manometer - to measure static pressure, pressure drop across coils, filters, and draft.
5. Water Manometer (12") - to test gas inlet and manifold pressure.

Other recording type instruments can be essential in solving abnormal problems, however, in many instances they may be rented from local sources.

Proper equipment promotes faster, more efficient service and accurate repairs resulting in fewer call backs.

HEATING PERFORMANCE TEST

Before attempting to diagnose an operating fault code, run a Heating Performance Test to determine if the heating system is performing within 5% of the BTU input found on the rating plate of the unit being tested. To conduct a heating performance test, the BTU input to the unit must be calculated (see Clocking a Gas Meter). Before clocking a gas meter, contact your local utility to provide the caloric value (BTU content) of the natural gas in the area.

It is also important to confirm the airflow (CFM) is within the temperature rise range (see Airflow Data in spec sheet) and external static pressure range (approximately 0.5" water column). How-to instructions can be found in the service manual under Checking External Static Pressure and Checking Temperature Rise.

SCHEDULED MAINTENANCE

CLOCKING A GAS METER

1. Turn off all gas appliances in the home.
2. Turn on the furnace. Ensure the furnace is operating at a 100% firing rate on 2 stage and modulating furnace product.
3. Once heating cycle is at a steady state (typically 15 minutes of operation), use a stopwatch to time how long it takes the smallest unit of measure dial on the gas meter to make a full revolution. In Table 1, one cubic foot is selected. The smallest unit of measure will vary depending on the gas meter.

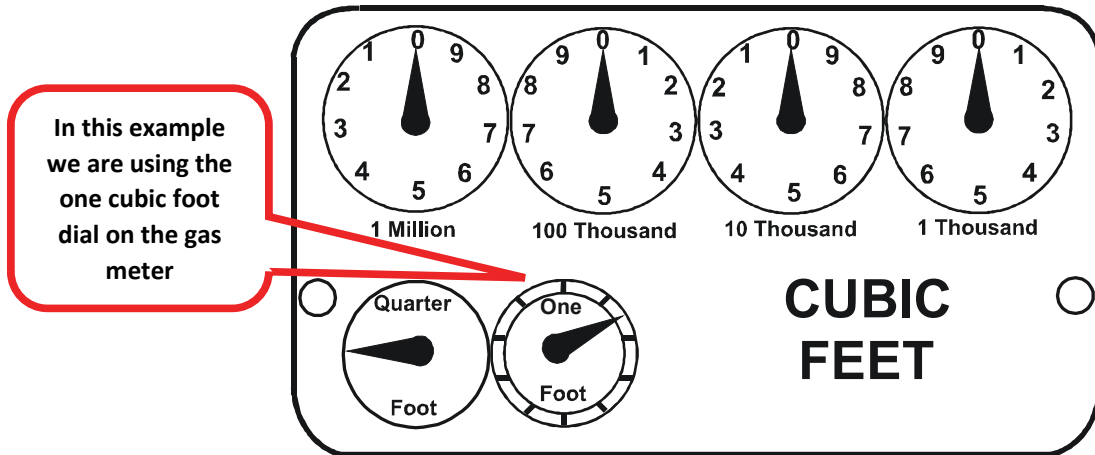

TABLE 1

4. Using Table 2 below, find the number of seconds it took for the dial to make a full revolution. To the right of that number of seconds and below the Size of Test Dial (selected in step 3 and shown in Table 1) will be the Cubic Feet per Hour (CFH).

Locate 40 seconds for one revolution in the chart below

Then locate the 1 cu ft dial column and select the corresponding CFH from the 40 seconds for one revolution row

| GAS RATE -- CUBIC FEET PER HOUR | | | | | | | | | | | |
|---------------------------------|-------------------|-----------|---------|---------|---------|----------------------------|-------------------|-----------|---------|---------|---------|
| Seconds for One Revolution | Size of Test Dial | | | | | Seconds for One Revolution | Size of Test Dial | | | | |
| | 1/4 cu/ft | 1/2 cu/ft | 1 cu/ft | 2 cu/ft | 5 cu/ft | | 1/4 cu/ft | 1/2 cu/ft | 1 cu/ft | 2 cu/ft | 5 cu/ft |
| 10 | 90 | 180 | 360 | 720 | 1800 | 36 | 25 | 50 | 100 | 200 | 500 |
| 11 | 82 | 164 | 327 | 655 | 1636 | 37 | -- | -- | 97 | 195 | 486 |
| 12 | 75 | 150 | 300 | 600 | 1500 | 38 | 23 | 47 | 95 | 189 | 474 |
| 13 | 69 | 138 | 277 | 555 | 1385 | 39 | -- | -- | 92 | 185 | 462 |
| 14 | 64 | 129 | 257 | 514 | 1286 | 40 | 22 | 45 | 90 | 180 | 450 |
| 15 | 60 | 120 | 240 | 480 | 1200 | 41 | -- | -- | -- | 176 | 439 |
| 16 | 56 | 113 | 225 | 450 | 1125 | 42 | 21 | 43 | 86 | 172 | 429 |
| 17 | 53 | 106 | 212 | 424 | 1059 | 43 | -- | -- | -- | 167 | 419 |
| 18 | 50 | 100 | 200 | 400 | 1000 | 44 | -- | 41 | 82 | 164 | 409 |
| 19 | 47 | 95 | 189 | 379 | 947 | 45 | 20 | 40 | 80 | 160 | 400 |
| 20 | 45 | 90 | 180 | 360 | 900 | 46 | -- | -- | 78 | 157 | 391 |
| 21 | 43 | 86 | 171 | 343 | 857 | 47 | 19 | 38 | 76 | 153 | 383 |
| 22 | 41 | 82 | 164 | 327 | 818 | 48 | -- | -- | 75 | 150 | 375 |
| 23 | 39 | 78 | 157 | 313 | 783 | 49 | -- | -- | -- | 147 | 367 |
| 24 | 37 | 75 | 150 | 300 | 750 | 50 | 18 | 36 | 72 | 144 | 360 |
| 25 | 36 | 72 | 144 | 288 | 720 | 51 | -- | -- | -- | 141 | 355 |
| 26 | 34 | 69 | 138 | 277 | 692 | 52 | -- | -- | 69 | 138 | 346 |
| 27 | 33 | 67 | 133 | 265 | 667 | 53 | 17 | 34 | -- | 136 | 340 |
| 28 | 32 | 64 | 129 | 257 | 643 | 54 | -- | -- | 67 | 133 | 333 |
| 29 | 31 | 62 | 124 | 248 | 621 | 55 | -- | -- | -- | 131 | 327 |
| 30 | 30 | 60 | 120 | 240 | 600 | 56 | 16 | 32 | 64 | 129 | 321 |
| 31 | -- | -- | 116 | 232 | 581 | 57 | -- | -- | -- | 126 | 316 |
| 32 | 28 | 56 | 113 | 225 | 563 | 58 | -- | 31 | 62 | 124 | 310 |
| 33 | -- | -- | 109 | 218 | 545 | 59 | -- | -- | -- | 122 | 305 |
| 34 | 26 | 53 | 106 | 212 | 529 | 60 | 15 | 30 | 60 | 120 | 300 |
| 35 | -- | -- | 103 | 206 | 514 | -- | -- | -- | -- | -- | -- |

TABLE 2

SCHEDULED MAINTENANCE

5. Use this formula to verify the Cubic Feet per Hour (CFH) input determined in step 4 is correct:

$$(3600 \times \text{Gas Meter Dial Size}) / \text{Time (seconds)} = \text{Cubic Feet per Hour (CFH)}$$

3600 is used as there are 60 seconds in a minute and 60 minutes in an hour.
60x60=3600

6. Check with your local utility for actual BTU content (caloric value) of natural gas in the area (the average is 1025 BTU's).
7. Use this formula to calculate the BTU/HR input (See BTU/HR Calculation Example):

$$\text{Cubic Feet per Hour (CFH)} \times \text{BTU content of your natural gas} = \text{BTU/HR input}$$

8. Should the figure you calculated not fall within five (5) percent of the nameplate rating of the unit, adjust the gas valve pressure regulator or resize orifices. To adjust the pressure regulator on the gas valve, turn downward (clockwise) to increase pressure and input, and upward (counterclockwise) to decrease pressure and input. A properly operating unit must have the BTU per hour input and CFM of air, within the limits shown to prevent short cycling of the equipment. As the external static pressure goes up, the temperature rise will also increase. Consult the proper tables for temperature rise limitation.

BTU/HR Calculation Example:

The unit being tested takes 40 seconds for the 1 cubic foot dial to make one complete revolution. Using the chart, this translates to 90 cubic feet per hour. Based upon the assumption that one cubic foot of natural gas has 1,025 BTU's (Check with your local utility for actual BTU content), the **calculated input is 92,250 BTU's per hour.**

Furnace Nameplate Input in this example: 90,000 BTU/HR

Calculated Gas Input in this example: 92,250 BTU/HR



This example is within the 5% tolerance input and does not need adjustment.

| |
|---|
|  CAUTION |
| ALWAYS CONNECT A MANOMETER TO THE OUTLET TAP AT THE GAS VALVE BEFORE ADJUSTING THE PRESSURE REGULATOR. IN NO CASE SHOULD THE FINAL MANIFOLD PRESSURE VARY MORE THAN PLUS OR MINUS .2 INCHES WATER COLUMN FROM 3 INCHES WATER COLUMN FOR NATURAL GAS. |

A properly operating unit must have the BTU per hour input and CFM of air, within the limits shown to prevent short cycling of the equipment. As the external static pressure goes up, the temperature rise will also increase. Consult the proper tables for temperature rise limitation.

SERVICING

CHECKING VOLTAGE

| | |
|--|---|
|  WARNING |  |
| HIGH VOLTAGE DISCONNECT ALL POWER BEFORE SERVICING OR CHANGING ANY ELECTRICAL WIRING. MULTIPLE POWER SOURCES MAY BE PRESENT. FAILURE TO DO SO MAY CAUSE PROPERTY DAMAGE, PERSONAL INJURY OR DEATH. | |

1. Remove the burner door to gain entry to the Junction Box.
2. Remove cover from the Junction Box and gain access to incoming power lines.

With Power ON:

| |
|--|
|  WARNING |
| LINE VOLTAGE NOW PRESENT |

3. Using a voltmeter, measure the voltage across the hot and neutral connections.

NOTE: To energize the furnace, the Door Interlock Switch must be engaged at this point.

4. No reading - indicates open wiring, open fuse, no power, or faulty Door Interlock Switch from unit to fused disconnect service. Repair as needed.
5. With ample voltage at line voltage connectors, energize the furnace blower motor by jumpering terminals R to G on the integrated ignition control.
6. With the blower motor in operation, the voltage should be 115 volts \pm 10 percent.
7. If the reading falls below the minimum voltage, check the line wire size. Long runs of undersized wire can cause low voltage. If wire size is adequate, notify the local power company of the condition.
8. After completing check and/or repair, replace Junction Box cover and reinstall the service panel doors.
9. Turn on electrical power and verify proper unit operation.

CHECKING WIRING

| |
|--|
|  WARNING |
| DISCONNECT ALL POWER BEFORE SERVICING. |

1. Check wiring visually for signs of overheating, damaged insulation and loose connections.
2. Use an ohmmeter to check continuity of any suspected open wires.
3. If any wires must be replaced, replace with AWM, 105°C. 2/64 thick insulation of the same gauge or its equivalent.

CHECKING THERMOSTAT, WIRING

| |
|--|
|  WARNING |
| DISCONNECT ALL POWER BEFORE SERVICING. |

1. Remove the blower compartment door to gain access to the thermostat low voltage wires located at the furnace integrated control module terminals.
2. Remove the thermostat low voltage wires at the furnace control panel terminal board.
3. Jumper terminals R to W on the integrated ignition control.

With Power On (and Door Interlock Switch closed):

| |
|--|
|  WARNING |
| LINE VOLTAGE NOW PRESENT |



4. Induced Draft Motor must run and pull in pressure switch.
5. If the hot surface ignitor heats and at the end of the ignitor warm-up period the gas valve opens and the burners ignite, the trouble is in the thermostat or wiring.
6. With power off, check the continuity of the thermostat and wiring. Repair or replace as necessary.

If checking the furnace in the air conditioning mode, proceed as follows.

7. With power off, Jumper terminals R to Y to G.
8. Turn on the power.
9. If the furnace blower motor starts and the condensing unit runs, then the trouble is in the thermostat or wiring. Repair or replace as necessary.
10. After completing check and/or repair of wiring and check and/or replacement of thermostat, reinstall blower compartment door.
11. Turn on electrical power and verify proper unit operation.

CHECKING TRANSFORMER AND CONTROL CIRCUIT

A step-down transformer 120 volt primary to 24 volt secondary, 40 VA (Heating and Cooling Models) supplies ample capacity of power for either operation.

| | |
|--|---|
|  WARNING |  |
| HIGH VOLTAGE DISCONNECT ALL POWER BEFORE SERVICING OR CHANGING ANY ELECTRICAL WIRING. MULTIPLE POWER SOURCES MAY BE PRESENT. FAILURE TO DO SO MAY CAUSE PROPERTY DAMAGE, PERSONAL INJURY OR DEATH. | |

SERVICING

1. Remove blower compartment door to gain access to the thermostat low voltage wires located at the furnace integrated control module.
2. Remove the thermostat low voltage wires at the furnace integrated control module terminals.

With Power On (and Door Interlock Switch closed):



3. Use a voltmeter, check voltage across terminals R and C. Must read 24 VAC.
4. No voltage indicates faulty transformer, open fuse, bad wiring, bad splice, or open door interlock switch.
5. Check transformer primary voltage at incoming line voltage connections, fuse, splices, and blower door interlock switch.
6. If line voltage is available to the primary side of transformer and not at secondary side, the transformer is inoperative. Replace.
7. After completing check and/or replacement of transformer and check and/or repair of control circuit, reinstall blower compartment door.
8. Turn on electrical power and verify proper unit operation.

CHECKING AIR CIRCULATOR BLOWER MOTOR



1. Remove blower compartment door to gain access to the circulator blower motor and integrated ignition control.
2. Disconnect the motor wire leads from its connection point at the integrated ignition control module and capacitor if applicable.
3. Using a ohmmeter, test for continuity between each of the motor leads.
4. Touch one probe of the ohmmeter to the motor frame (ground) and the other probe in turn to each lead.

If the windings do not test continuous or a reading is obtained to ground, replace the motor.

5. After completing check and/or replacement of circulator blower motor or induced draft blower motor, reinstall blower compartment door.
6. Turn on electrical power and verify proper unit operation.



CHECKING DUCT STATIC

The maximum and minimum allowable external static pressures are found in the specification section. These tables also show the amount of air being delivered at a given static by a given motor speed or pulley adjustment.

The furnace motor cannot deliver proper air quantities (CFM) against statics other than those listed.

Too great of an external static pressure will result in insufficient air that can cause excessive temperature rise, resulting in limit tripping, etc. Whereas not enough static may result in motor overloading.

To determine proper air movement, proceed as follows:

1. With clean filters in the furnace, use a draft gauge (inclined manometer) to measure the static pressure of the return duct at the inlet of the furnace. (Negative Pressure)
2. Measure the static pressure of the supply duct. (Positive Pressure)
3. Add the two (2) readings together for total external static pressure.

NOTE: Both readings may be taken simultaneously and read directly on the manometer if so desired. If an air conditioner coil or Electronic Air Cleaner is used in conjunction with the furnace, the readings must also include these components, as shown in the following drawing.

4. Consult proper tables for the quantity of air.

If the total external static pressure exceeds the minimum or maximum allowable statics, check for closed dampers, registers, undersized and/or oversized poorly laid out duct work.

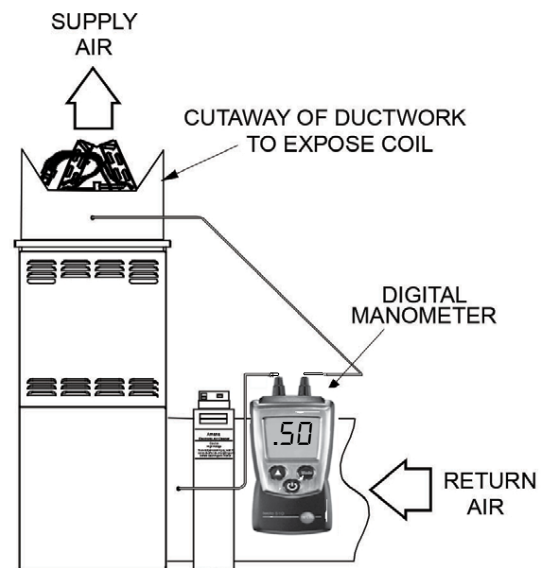

Checking Static Pressure

CHECKING TEMPERATURE RISE

The more air (CFM) being delivered through a given furnace, the less the rise will be; so the less air (CFM) being delivered, the greater the rise. The temperature rise should be adjusted in accordance to a given furnace specifications and its

SERVICING

external static pressure. An incorrect temperature rise may result in condensing in or overheating of the heat exchanger. An airflow and temperature rise table is provided in the blower performance specification section. Determine and adjust temperature rise as follows:

1. Operate furnace with burners firing for approximately ten minutes. Check BTU input to furnace - do not exceed input rating stamped on rating plate. Ensure all registers are open and all duct dampers are in their final (fully or partially open) position.
2. Place thermometers in the return and supply ducts as close to the furnace as possible. Thermometers must not be influenced by radiant heat by being able to "see" the heat exchanger.

CROSS-HATCHED AREA SUBJECTED TO RADIANT HEAT. DO NOT MEASURE SUPPLY AIR TEMPERATURE IN THIS AREA.

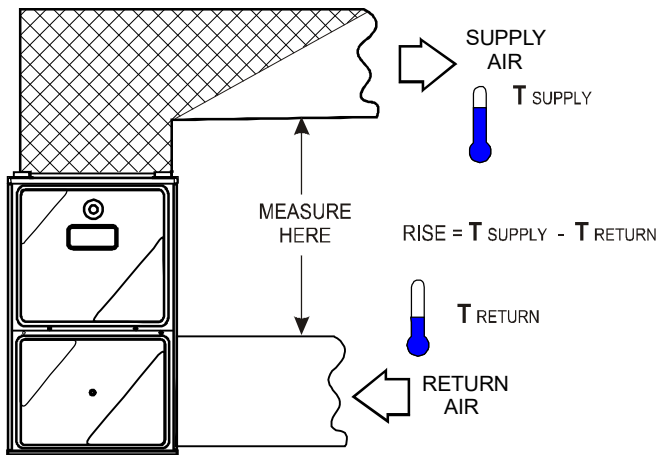

Checking Temperature Rise

3. Subtract the return air temperature from the supply air temperature to determine the air temperature rise. Allow adequate time for thermometer readings to stabilize.
4. Adjust temperature rise by adjusting the circulator blower speed. Increase blower speed to reduce temperature rise. Decrease blower speed to increase temperature rise. Refer to *Circulator Blower Speed* section in the Product Design section of this manual for speed changing details. Temperature rise is related to the BTUH output of the furnace and the amount of air (CFM) circulated over the heat exchanger. Measure motor current draw to determine that the motor is not overloaded during adjustments.

CHECKING PRIMARY LIMIT CONTROL

All use a nonadjustable, automatic reset, bi-metal type limit control.

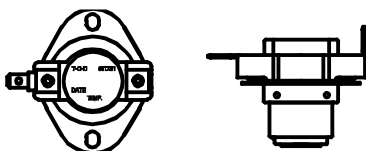

Style 1

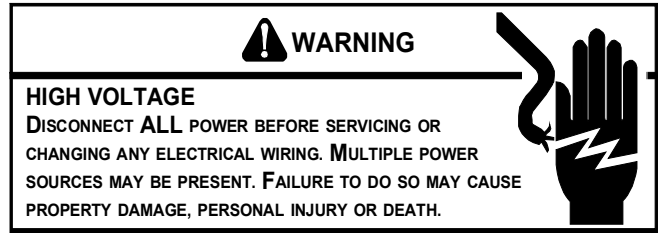

1. Remove burner compartment door to gain access to the primary limit.
2. Remove low voltage wires at limit control terminals.
3. With an ohmmeter, test between these two terminals as shown in the following drawing. The ohmmeter should read continuous unless heat exchanger temperature is above limit control setting. If not as above, replace the control.

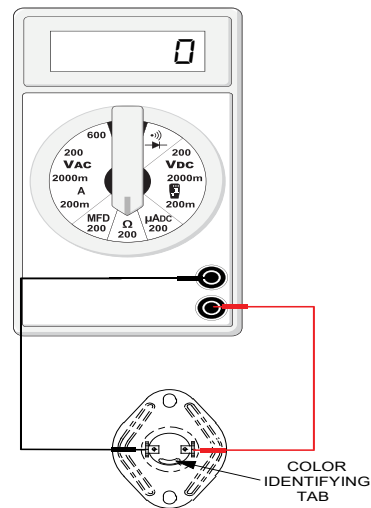

Testing Primary Limit Control

CHECKING AUXILIARY LIMIT CONTROL

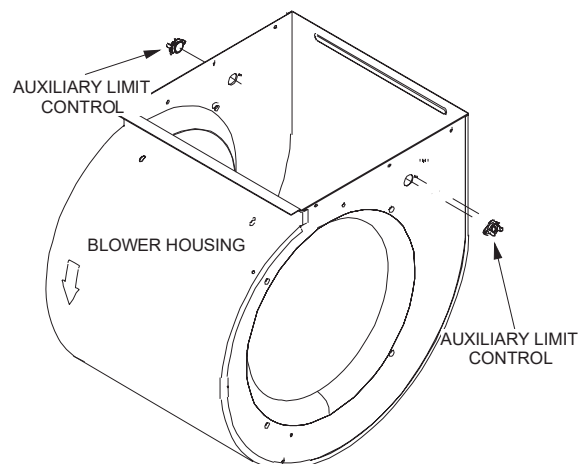

Auxiliary Limit Control Location

SERVICING

| | |
|--|---|
| ⚠ WARNING |  |
| HIGH VOLTAGE DISCONNECT ALL POWER BEFORE SERVICING OR INSTALLING THIS UNIT. MULTIPLE POWER SOURCES MAY BE PRESENT. FAILURE TO DO SO MAY CAUSE PROPERTY DAMAGE, PERSONAL INJURY OR DEATH. | |

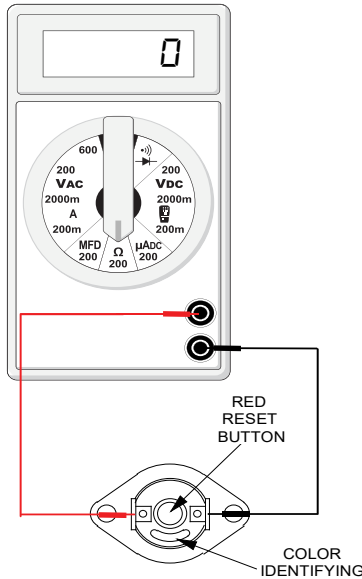

Testing Auxiliary Limit Control

| |
|--|
| ⚠ WARNING |
| TO AVOID POSSIBLE FIRE, ONLY RESET THE AUXILIARY LIMIT CONTROL ONCE. IF IT SHOULD OPEN A SECOND TIME, A QUALIFIED SERVICER MUST DETERMINE WHY THE AUXILIARY LIMIT OPENED BEFORE RESETTING AGAIN. |

INDUCED DRAFT BLOWER MOTOR

| | |
|--|---|
| ⚠ WARNING |  |
| HIGH VOLTAGE DISCONNECT ALL POWER BEFORE SERVICING OR INSTALLING THIS UNIT. MULTIPLE POWER SOURCES MAY BE PRESENT. FAILURE TO DO SO MAY CAUSE PROPERTY DAMAGE, PERSONAL INJURY OR DEATH. | |

The induced draft assembly uses a three phase motor to draw flue gases through the heat exchanger. The inducer uses ball bearings and is permanently lubricated. This motor is driven at varying speeds by the VFD (variable frequency drive) section of the IFC. The IFC takes typical single phase power supplied to the furnace and converts it to a three phase supply to operate the draft inducer at the desired speed. The windings of the induced draft motor will

have equal resistance +/- 5%. Normal resistance readings at room temperature will range from 14-17 ohms. The voltage supplied by the IFC to drive the induced draft blower will vary from 15-110 volts A/C between any two windings. This would be read between any two of the three power wires between the IFC and the induced draft blower. This voltage to the IBD will vary between furnace models and is dependent on what percentage of maximum fire is being called for. The power wires are colored red, white, and black. A green colored ground wire is also present.

CHECKING GAS VALVE (Redundant)

A combination redundant operator type gas valve which provides all manual and automatic control functions required for gas fired heating equipment is used.

The valve provides control of main burner gas flow, pressure regulation, and 100 percent safety shut-off.

| |
|---------------------------------------|
| ⚠ WARNING |
| DISCONNECT ALL POWER BEFORE SERVICING |

Single stage gas valves should be tested on the furnace with 24 VAC connected to the gas valve and manometers reading supply line and manifold pressures.

| |
|---|
| ⚠ WARNING |
| DISCONNECT ALL GAS AND ELECTRICAL POWER SUPPLY. |

Orifices should be treated with care in order to prevent damage. They should be removed and installed with a box-end wrench in order to prevent distortion. In no instance should an orifice be peened over and redrilled. This will change the angle or deflection of the vacuum effect or entraining of primary air, which will make it difficult to adjust the flame properly. This same problem can occur if an orifice spud of a different length is substituted.

| |
|---|
| ⚠ WARNING |
| DISCONNECT ALL GAS AND ELECTRICAL POWER SUPPLY. |

CHECKING GAS PRESSURE

Gas Supply Pressure Measurement

| |
|---|
| ⚠ CAUTION |
| TO PREVENT UNRELIABLE OPERATION OR EQUIPMENT DAMAGE, THE INLET GAS SUPPLY PRESSURE MUST BE AS SPECIFIED ON THE UNIT RATING PLATE WITH ALL OTHER HOUSEHOLD GAS FIRED APPLIANCES OPERATING. |

Gas inlet and manifold pressures should be checked and adjusted in accordance to the type of fuel being consumed. The line pressure supplied to the gas valve must be within the

SERVICING

range specified below. The supply pressure can be measured at the gas valve inlet pressure tap or at a hose fitting installed in the gas piping drip leg. The supply pressure must be measured with the burners operating. To measure the gas supply pressure, use the following procedure.

⚠ WARNING

DISCONNECT ELECTRICAL POWER AND SHUT OFF GAS SUPPLY.

1. After turning off gas to furnace at the manual gas shutoff valve external to the furnace, remove burner compartment door to gain access to the gas valve.
2. Connect a calibrated water manometer (or appropriate gas pressure gauge) at either the gas valve inlet pressure tap or the gas piping drip leg as shown in the following figures. Refer to *Measuring Gas Pressure: Single Stage Valves* figure for single stage valve inlet pressure tap connections.

NOTE: At either location, a hose fitting must be installed prior to making the hose connection.

NOTE: Use apapter kit #0151K00000S to measure gas pressure on White-Rodgers 36J22 gas valves.

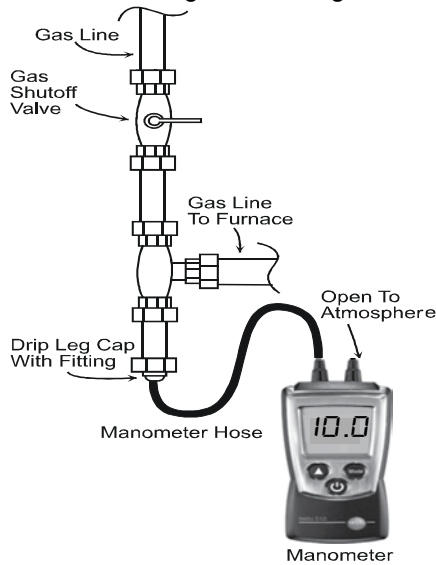

Measuring Inlet Gas Pressure (Alternate Method)

3. Turn ON the gas and electrical power supply and operate the furnace and all other gas consuming appliances on the same gas supply line.
4. Measure furnace gas supply pressure with burners firing. Supply pressure must be within the range specified in the following table.

| INLET GAS SUPPLY PRESSURE | | |
|---------------------------|--------------------|---------------------|
| Natural Gas | Minimum: 4.5" w.c. | Maximum: 10.0" w.c. |

If supply pressure differs from above, make necessary adjustments to pressure regulator, gas piping size, etc., and/or consult with local gas utility.

⚠ WARNING

HIGH VOLTAGE
DISCONNECT ALL ELECTRICAL POWER AND SHUT OFF GAS SUPPLY BEFORE SERVICING OR INSTALLING THIS UNIT.
MULTIPLE POWER SOURCES MAY BE PRESENT. FAILURE TO DO SO MAY CAUSE PROPERTY DAMAGE, PERSONAL INJURY OR DEATH.

5. Disconnect manometer after turning off gas at manual shutoff valve. Reinstall plug before turning on gas to furnace.
6. Turn OFF any unnecessary gas appliances started in step 3.
7. Turn on gas to furnace and check for leaks. If leaks are found, repair and then reinstall burner compartment door.
8. Turn on electrical power and verify proper unit operation.

Gas Manifold Pressure Measurement and Adjustment

⚠ CAUTION

TO PREVENT UNRELIABLE OPERATION OR EQUIPMENT DAMAGE, THE GAS MANIFOLD PRESSURE MUST BE AS SPECIFIED ON THE UNIT RATING PLATE. ONLY MINOR ADJUSTMENTS SHOULD BE MADE BY ADJUSTING THE GAS VALVE PRESSURE REGULATOR.

NOTE: Use apapter kit #0151K00000S to measure gas pressure on White-Rodgers 36J22 gas valves.

Only small variations in gas pressure should be made by adjusting the gas valve pressure regulator. The manifold pressure must be measured with the burners operating. To measure and adjust the manifold pressure, use the following procedure.

⚠ WARNING

HIGH VOLTAGE
DISCONNECT ALL ELECTRICAL POWER AND SHUT OFF GAS SUPPLY BEFORE SERVICING OR INSTALLING.

1. After turning off gas to furnace at the manual gas shutoff valve external to the furnace, remove burner compartment door to gain access to the gas valve.
2. Connect a calibrated water manometer (or appropriate gas pressure gauge) at the gas valve outlet pressure tap. Refer to *Measuring Gas Pressure: Single Stage Valves* figure for single stage valve outlet pressure tap connections.

⚠ WARNING

LINE VOLTAGE NOW PRESENT

SERVICING

3. Turn ON the gas and electrical power supply and operate the furnace.
4. Measure gas manifold pressure with burners firing. Adjust manifold pressure using the table below.

| Manifold Gas Pressure | |
|-----------------------|----------------|
| Natural Gas | 2.8 -3.2" w.c. |

The final manifold pressure must not vary from the above specified pressures. Any necessary major changes in gas flow rate should be made by changing the size of the burner orifice.

5. White-Rodgers 36J22 Valves:
 - a. Back outlet pressure test screw (inlet/outlet pressure boss) out one turn (counterclockwise, not more than one turn).
 - b. Attach a hose and manometer to the outlet pressure outlet pressure boss.
 - c. Turn ON the gas supply.
 - d. Turn on power and close thermostat "R" and "W" contacts to provide a call for low stage heat.
 - e. Measure the gas manifold pressure with burners firing. Adjust manifold pressure using the *Manifold Gas Pressure* table shown below.
 - f. Remove regulator cover screw from the outlet pressure regulator adjust tower and turn screw clockwise to increase pressure or counterclockwise to decrease pressure. Replace regulator cover screw.
 - i. Turn off all electrical power and gas supply to the system.
 - j. Remove the manometer hose from the hose barb fitting or outlet pressure boss.
 - k. Turn outlet pressure test screw in to seal pressure port (clockwise, 7 in-lb minimum).

WARNING

HIGH VOLTAGE
DISCONNECT ALL ELECTRICAL POWER AND SHUT OFF GAS SUPPLY BEFORE SERVICING OR INSTALLING.

WARNING

DISCONNECT ALL POWER BEFORE SERVICING.

CHECKING HOT SURFACE IGNITER

120V Silicon Nitride Igniter - ULN furnaces use a 120V silicone nitride igniter, part #0130F00717. The normal operating temperature is approximately 2156°F - 2678°F. At room temperature the igniter ohm reading should be from 20-100 ohms.

WARNING

LINE VOLTAGE NOW PRESENT

CHECKING PRESSURE TRANSDUCER (80% ULN)

The 80% ULN products utilize a pressure transducer (in lieu of a pressure switch). The pressure transducer signals the control board to modulate the heating cycle during a call for heat by regulating the induced draft motor speed. By regulating the speed of the induced draft motor, proper air-fuel ratios are maintained.

Sensing range specification: 0.0-4.0 inches W.C.

Voltage specifications:

- Steady State: 5.0 vDC from red to green wire (transducer wiring harness input)
- With Inducer off: 0.5 vDC from black to green wire (transducer wiring harness output).
- During operation: Output range equals 0.5 - 4.5 vDC

Potential errors:

1. Control board does not receive 0.25 vDC for inducer motor with motor off
 - a. Will result in 2-flash error code on the control board
2. Control board does not receive the required voltage change (0.5 - 4.5 vDC) during inducer motor operation.
 - a. Will result in 3-flash error code on the control board

WARNING

HIGH VOLTAGE
DISCONNECT ALL POWER BEFORE SERVICING OR INSTALLING THIS UNIT. MULTIPLE POWER SOURCES MAY BE PRESENT. FAILURE TO DO SO MAY CAUSE PROPERTY DAMAGE, PERSONAL INJURY OR DEATH.

WARNING

HIGH VOLTAGE
DISCONNECT ALL ELECTRICAL POWER AND SHUT OFF GAS SUPPLY BEFORE SERVICING OR INSTALLING THIS UNIT.
MULTIPLE POWER SOURCES MAY BE PRESENT. FAILURE TO DO SO MAY CAUSE PROPERTY DAMAGE, PERSONAL INJURY OR DEATH.

6. Turn on gas to furnace and check for leaks. If leaks are found, repair and then reinstall burner compartment door.
7. Turn on electrical power and verify proper unit operation.

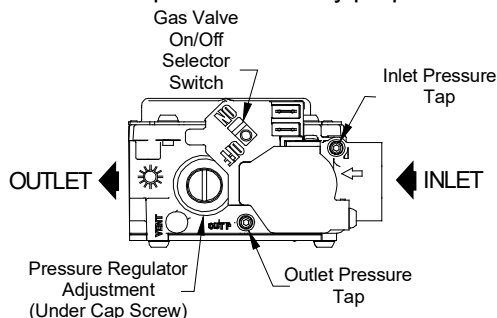

SERVICING

CHECKING FOR DELAYED IGNITION

Delayed ignition is a delay in lighting a combustible mixture of gas and air which has accumulated in the combustion chamber.

Furnace design makes this extremely unlikely unless safety controls have been by-passed or tampered with. Never by-pass or alter furnace controls.

If delayed ignition should occur, the following should be checked:

1. Improper gas pressure - adjust to proper pressure (See *CHECKING GAS PRESSURE*).

CHECKING INTEGRATED IGNITION CONTROL BOARDS

NOTE: Failure to earth ground the furnace, reversing the neutral and hot wire connection to the line (polarity), or a high resistance connection in the neutral line may cause the control to lockout due to failure to sense flame.

| |
|--|
|  WARNING |
| TO AVOID THE RISK OF ELECTRICAL SHOCK, WIRING TO THE UNIT MUST BE PROPERLY POLARIZED AND GROUNDED. DISCONNECT POWER BEFORE PERFORMING SERVICE LISTED BELOW. |

The ground wire must run from the furnace all the way back to the electrical panel. Proper grounding can be confirmed by disconnecting the electrical power and measuring resistance between the neutral (white) connection and the burner closest to the flame sensor. Resistance should be less than 10 ohms.



The ignition control is a combination electronic and electromechanical device and is not field repairable. Complete unit must be replaced.

| |
|--|
|  WARNING |
| LINE VOLTAGE NOW PRESENT |

These tests must be completed within a given time frame due to the operation of the ignition control.

1. Check for 120 volts from Line 1 (Hot) to Line 2 (Neutral) at the ignition control. No voltage, check the door switch connections and wire harness for continuity.
2. Check for 24 volts from W to C terminal on the ignition control. No voltage. Check transformer, room thermostat, and wiring.
If you have 24 volts coming off the transformer but receive approximately 13 volts on the terminal board between (C) and (R), check for blown fuse.
3. Check for 120 volts to the induced draft blower by measuring voltage between Pin 4 & 5 (black & white wire on 5 pin connector.)

4. If voltage is present in Steps 1 through 3 and the induced draft blower is operating, check for 120 volts to the ignitor during the preheat cycle.
5. After the ignitor warmup time, begin checking for 24 volts to the gas valve. Voltage will be present for seven seconds only if proof of flame has been established.

| | |
|--|---|
|  WARNING |  |
| HIGH VOLTAGE DISCONNECT ALL POWER BEFORE SERVICING OR INSTALLING THIS UNIT. MULTIPLE POWER SOURCES MAY BE PRESENT. FAILURE TO DO SO MAY CAUSE PROPERTY DAMAGE, PERSONAL INJURY OR DEATH. | |

CHECKING FLAME SENSOR

1. Disconnect the yellow flame sensor wire from the sensor
2. Connect a micro-amp meter in series with this wire and the sensor terminal.
3. Place the unit into a heating cycle.

| |
|--|
|  WARNING |
| LINE VOLTAGE NOW PRESENT |

4. As soon as flame is established a micro-amp reading should be evident once proof of flame (micro-amp reading) is established, the hot surface ignitor will be de-energized.
5. The Integrated Ignition controls will have 2 - 4 uAmps. Anything below .08 uAmps and the unit will shut down. If the micro-amp reading is less than the minimum specified, check for high resistance wiring connections, sensor to burner gap, dirty flame sensor, or poor grounding.
6. If absolutely no reading, check for continuity on all components and if good - replace ignition control module.

NOTE: Contaminated fuel or combustion air can create a nearly invisible coating on the flame sensor. This coating works as an insulator causing a loss in the flame sense signal. If this situation occurs the flame sensor must be cleaned with steel wool.

TROUBLESHOOTING

MENU OPTIONS

| LED Display | Menu Description |
|-------------|---|
| <i>A5E</i> | Aux (condensate switch enabled) |
| <i>b5t</i> | Enable or disable inverter boost operation. (compressor speed may increase when this feature is on) (inverter only) |
| <i>btt</i> | Boost mode will operate above this selected temperature. On = boost mode always on (default = 105°F) (inverter only) |
| <i>CP</i> | Cooling Airflow Profile setting (default = profile D shown as 4) |
| <i>cbP</i> | Heat Pump compressor lockout temperature. Furnace will act as primary heat source below this temperature. (Default = 45°F) |
| <i>cdL</i> | Compressor off delay at the beginning and end of a defrost cycle. (default = 30 seconds) |
| <i>CFd</i> | Cooling Airflow Off Delay Time. (default = 60 seconds) |
| <i>CLr</i> | Resets all cooling settings to a factory default |
| <i>Cnd</i> | Cooling Airflow On Delay Time (default = 5 seconds) |
| <i>Cr</i> | Control Firmware Revision Number |
| <i>Cr9</i> | Enable or disable inverter charge mode |
| <i>CrP</i> | Select the range that includes the desired compressor RPS for inverter cooling operation. See inverter manual for menu options |
| <i>Cr5</i> | Maximum Compressor RPS for cooling mode (inverter only) |
| <i>C5t</i> | Percentage of high stage cooling airflow to run during low stage operation (default = 70%) |
| <i>CtF</i> | Cooling Airflow Trim (default 0%) |
| <i>CtH</i> | High Cooling Airflow Trim for inverter units. See inverter manual for menu options and defaults |
| <i>CtI</i> | Intermediate Cooling Airflow Trim for inverter units. See inverter manual for menu options and defaults |
| <i>CtL</i> | Low Cooling Airflow Trim for inverter units. See inverter manual for menu options and defaults |
| <i>dF</i> | Compressor run time between defrost cycles. (default = 30 minutes) (2 stage units) |
| <i>dHE</i> | Enables or disables dehumidification feature in the outdoor unit (default = Enabled) |
| <i>dHL</i> | Select "1" to enable dehumidification when the thermostat DH terminal is energized. Select "0" to enable dehumidification when the thermostat DH terminal is de-energized (default = 1) |
| <i>FCL</i> | View 6 most recent fault codes and Clear Fault Codes if desired (outdoor communicating units) |
| <i>FdF</i> | Force system into a defrost cycle (inverter units) |
| <i>F5d</i> | Constant Fan Speed as percent of maximum airflow (Default = 25%) |
| <i>GFd</i> | Gas Heat Fan Off Delay (default = 90 seconds) |
| <i>Gnd</i> | Gas Heat Fan On Delay (default = 30 seconds) |
| <i>g5t</i> | Percentage of high stage gas heating airflow to run during low stage gas heat operation (default = 70%) |
| <i>GH</i> | Gas Heat |

| LED Display | Menu Description |
|-------------|--|
| <i>gLF</i> | Gas Heat Airflow Trim (default = 0%) |
| <i>HdI</i> | Maximum Compressor Run Time Between Defrost Cycles (default = 120 minutes) |
| <i>HFd</i> | Heat Pump Heating Airflow Off Delay Time (default = 60 seconds) |
| <i>Hnd</i> | Heat Pump Heating Airflow On Delay Time (default = 5 seconds) |
| <i>HrP</i> | Select the range that includes the desired compressor RPS for inverter heating operation. See inverter manual for menu options |
| <i>Hr5</i> | Maximum Compressor RPS for Heating Mode (inverter only) |
| <i>Hrt</i> | Reset all heat pump heating settings to factory default. |
| <i>H5t</i> | Percentage of high stage heat pump heating airflow to run during low stage operation. (default = 70%) |
| <i>HLF</i> | Heat Pump Indoor Airflow Trim (default = 0%) |
| <i>HLH</i> | High Heating Airflow Trim for Inverter Units. See inverter manual for menu options and defaults |
| <i>HLI</i> | Intermediate Heating Airflow Trim for Inverter Units. See inverter manual for menu options and defaults |
| <i>HLL</i> | Low Heating Airflow Trim for Inverter Units. See inverter manual for menu options and defaults |
| <i>L6F</i> | View 6 most recent fault codes and clear all fault codes if desired. (furnace) |
| <i>Lrn</i> | Restart communications between the indoor and outdoor unit. |
| <i>Od5</i> | Select the number of stages for the non-communicating outdoor unit. Default = OFF meaning no outdoor unit. |
| <i>PPd</i> | Enable Pump Down Mode |
| <i>rFd</i> | Resets furnace settings to factory defaults. |
| <i>SCt</i> | Maximum Current Option (system will limit capacity to percentage of maximum current) (default = 100%) |
| <i>5r</i> | Control Shared Data Revision Number |
| <i>5rt</i> | Resets all outdoor unit settings to factory defaults. |
| <i>5Ut</i> | System Verification Test (inverters only) |
| <i>ton</i> | Indoor Airflow for non-communicating outdoor units. (values based on 400CFM per ton) (default = 3.0 Ton) |
| <i>Utr</i> | Select Outdoor Unit Elevation (SL=same level, OL = outdoor lower, IL = indoor lower) Default = Outdoor Lower |
| <i>CF5</i> | 1 = system will try to satisfy the thermostat quickly. 5 (default) = system will try to satisfy the thermostat more slowly. |
| <i>t9t</i> | Menu is enabled if the <i>CF5</i> menu is set to 6. Select the target time the system will attempt to satisfy the thermostat. |
| <i>SUP</i> | Menu is enabled if the <i>CF5</i> menu is set to 6. Select the percentage past the target time when the system will transition to gas furnace operation during heat mode. |
| <i>0tt</i> | Menu is enabled if the <i>CF5</i> is set to 6. (the gas furnace will run during the next heat call if the heat pump fails to satisfy the custom target time for this number of consecutive cycles) (default = 20 cycles) |
| <i>Utt</i> | Menu is enabled if the <i>CF5</i> menu is set to 6. (if low stage gas heat is able to consecutively satisfy the thermostat under the set target time for this number of cycles, the system will transition to the heat pump for primary heating) |
| <i>5dP</i> | Menu is enabled if the <i>CF5</i> menu is set to 6. (this percentage will help determine when switching back to heat pump operation is appropriate. Default = 20%. If target time = 20 minutes, low stage furnace operation must satisfy the thermostat by less than 16 minutes. (target time - 20% default = 16 minutes). |

TROUBLESHOOTING

STATUS CODES

| LED Display | Description of System Status |
|-------------|---|
| <i>1AC</i> | Compressor Cooling, Low Stage (non-communicating units) |
| <i>2AC</i> | Compressor Cooling, High Stage (non-communicating units) |
| <i>1AC</i> | Compressor Heat, Low Stage (non-communicating units) |
| <i>2AC</i> | Compressor Heat, High Stage (non-communicating units) |
| <i>AC</i> | Compressor Cooling, Single-Stage (single stage non-comm. units) |
| <i>AC 1</i> | Compressor Cooling, Low Stage (communicating units) |
| <i>AC 2</i> | Compressor Cooling, High Stage (communicating units) |
| <i>dHU</i> | Dehumidification |
| <i>FAn</i> | Constant Fan |
| <i>HP</i> | Compressor Heat, Single-Stage (single stage non-comm. units) |
| <i>HP 1</i> | Compressor Heat, Low Stage (Communicating Units) |
| <i>HP 2</i> | Compressor Heat, High Stage (Communicating Units) |
| <i>1 dL</i> | Idle |
| <i>uAC</i> | Inverter Cooling |
| <i>uHP</i> | Inverter Heating |
| <i>dFt</i> | Defrost |
| <i>GH</i> | Gas Heat |

TROUBLESHOOTING

| Symptom | LED Status | Fault Description | Corrective Actions |
|--|------------|--|--|
| | <i>d0</i> | Equipment lacks shared data | Populate shared data set using memory card |
| | <i>IDL</i> | Normal operation | None |
| Furnace fails to operate Integrated control module LED display provides no signal | None | No 115 power to furnace or no 24 volt power to integrated control module Blown fuse or tripped circuit breaker Integrated control module is non-functional | Restore high voltage power to furnace and integrated control module. Replace non-functional integrated control module. |
| Furnace fails to operate | <i>Eb0</i> | Circulator blower motor is not running when it should be running | Tighten or correct wiring connection Verify continuous circuit through inductor Replace if open or short circuit Check circulator blower motor, replace if necessary |
| Furnace fails to operate | <i>Eb1</i> | Integrated control module has lost communications with circulator blower motor | Tighten or correct wiring connection Check circulator blower motor. Replace if necessary Check integrated control module, replace if necessary |
| Furnace fails to operate | <i>Eb2</i> | Circulator blower motor horse power in shared data set does not match circulator blower motor horse power. | Verify circulator blower motor horse power match with nameplate, replace if necessary Verify shared data set is correct for the specific model, re-populate data using correct memory card if required |
| Furnace operates at reduced performance Airflow delivered is less than expected | <i>Eb3</i> | Circulator blower motor is operating in a power, temperature, or speed limiting condition | Check filters for blockage, clean filters or remove obstruction Check ductwork for blockage and verify all registers are fully open Verify ductwork is appropriately sized for system, resize and/or replace ductwork if necessary |
| Furnace fails to operate | <i>Eb4</i> | Circulator blower motor senses a loss of rotor control Circulator blower motor senses high current | Check filters, filter grille, registers, duct system and equipment inlet/outlet for blockage, make necessary corrections and retest |
| Furnace fails to operate | <i>Eb5</i> | Circulator blower motor fails to start 10 consecutive times | Check circulating blower for obstructions Repair or replace blower motor or wheel as required Check circulating blower shaft for proper rotation |
| Furnace fails to operate | <i>Eb6</i> | Circulator blower motor shuts down for over or under voltage condition Circulator blower motor shuts down due to over temperature condition on power module | Check voltage to furnace and verify within nameplate specified range |
| Furnace fails to operate | <i>Eb7</i> | Circulator blower motor lacks information to operate properly Motor fails to start 40 consecutive times | Check for locked rotor condition Check integrated control module and verify it is populated with the correct shared data |

TROUBLESHOOTING

| Symptom | LED Status | Fault Description | Corrective Actions |
|--|--------------|--|---|
| Furnace operates at reduced performance or operates on low stage when high stage is expected | <i>E b g</i> | Airflow is lower than demanded | <p>Check filters for blockage, clean filters or remove obstruction</p> <p>Check ductwork for blockage, remove obstruction and verify all registers are fully open</p> <p>Verify ductwork is appropriately sized for system, resize and/or replace ductwork if necessary</p> |
| Furnace fails to operate | <i>E l b</i> | Analog Pressure Sensor Reference Error. APS reference is out of the range (5.0+/-0.2)V for 5 seconds | Verify electrical connections to pressure sensor |
| Furnace fails to operate | <i>E l c</i> | Analog Pressure Sensor Null Error. Inconsistent Pressure reading with inducer OFF | Verify electrical connections to pressure sensor |
| Furnace fails to operate | <i>E l d</i> | Analog Pressure Sensor Span Error. Inconsistent pressure reading with inducer ON | Verify electrical connections to pressure sensor |
| Furnace fails to operate | <i>E l E</i> | Analog Pressure Error (Blocked Vent Error) | <p>Need to check the APS Sensor or its connection if this error is occurred. The failure conditions occur as per the following for 5 seconds:</p> <ol style="list-style-type: none"> 1. The vent is blocked, and the pressure could not reach (lower than) the target pressure when inducer stayed at maximum RPM which stored in Shared Data. 2. The vent is blocked, and the pressure could not reach (higher than) the target pressure when inducer stays at the minimum RPM (Pressure Switch Min Limit). 3. APS fault causes the pressure fixed at a value lower than the target pressure when inducer stayed at maximum RPM which stored in Shared Data. 4. APS fault causes the pressure fixed at a value higher than the target pressure when inducer stayed at minimum RPM (Pressure Switch Min Limit). |
| Furnace fails to Operate | <i>E l F</i> | Analog Pressure Sensor, Input Error | <p>Check the APS Sensor or its connection if this error is occurred. APS input voltage is out of the below ranges for 5 seconds.</p> <ol style="list-style-type: none"> 1. If 2" is selected, the voltage range shall be from (0.25-0.06)V to (4+0.06)V. 2. If 4" is selected, the voltage range shall be from (0.5-0.06)V to (4.5+0.06)V. |

TROUBLESHOOTING

| Symptom | LED Status | Fault Description | Corrective Actions |
|--|--------------|--|--|
| Furnace fails to operate | <i>E 10</i> | Grounding fault Poor neutral connection | Verify neutral wire connection to furnace & continuity to ground source |
| Furnace fails to operate | <i>E 11</i> | Open roll out switch | Check for correct gas pressure Check for correct burner alignment Check for and correct burner restriction |
| Furnace fails to operate | <i>E d0</i> | Data not yet on network | Populate shared data set using memory card |
| Operation different than expected or no operation | <i>E d 1</i> | Invalid memory card data | Verify shared data set is correct for the specific model, re-populate data using correct memory card if required |
| Furnace fails to operate | <i>E E0</i> | Furnace lockout due to an excessive number of ignition "retries" (3 total) Failure to establish flame Loss of flame after establishment | Locate and correct gas interruption Check front cover pressure switch operation and verify proper drainage (hose, wiring, contact operation), correct if necessary Replace or realign igniter Check flame sense signal, sand sensor if coated and/or oxidized Check flue piping for blockage, proper length, elbows, and termination Verify proper induced draft blower performance |
| Furnace fails to operate | <i>E E 1</i> | Low stage pressure switch circuit is closed at start of heating cycle Low stage pressure switch contacts sticking Short in pressure switch circuit wiring | Replace low stage pressure switch Repair short in wiring |
| Induced draft blower runs continuously with no furnace operation | <i>E E 2</i> | Low stage pressure switch circuit is not closed Pressure switch hose blocked pinched, or connected improperly Blocked flue and/or inlet air pipe, blocked drain system or weak induced draft blower Incorrect pressure switch set point or malfunctioning switch contacts Loose or improperly connected wiring | Inspect pressure switch hose, repair/replace if necessary Inspect flue and/or inlet air piping for blockage, proper length, elbows, and termination Check drain system, correct as necessary Check induced draft blower performance, correct as necessary Check pressure switch operation, replace as needed Tighten or correct wiring connection |
| Circulator blower runs continuously No furnace operation | <i>E E 3</i> | Primary limit circuit is open Insufficient conditioned air over the heat exchanger Blocked filters, restrictive ductwork, improper circulator blower speed, or failed circulator blower motor Loose or improperly connected wiring in high limit circuit | Check filters and ductwork for blockage Clean filters or remove obstruction Check circulator blower speed and performance Correct speed or replace blower motor if necessary Tighten or correct wiring connection |

TROUBLESHOOTING

| Symptom | LED Status | Fault Description | Corrective Actions |
|--|------------|--|--|
| Induced draft blower and circulator blower runs continuously No furnace operation | EE4 | Flame sensed with no call for heat Short to ground in flame sense circuit Lingering burner flame Slow closing gas valve | Correct short at flame sensor or in flame sensor wiring Check for lingering or lazy flame Verify proper operation of gas valve |
| No furnace operation | EE5 | Open fuse Short in low voltage wiring | Replace fuse Locate and correct short in low voltage wiring |
| Normal furnace operation | EE6 | Flame sense micro amp signal is low Flame sensor is coated/oxidized Flame sensor incorrectly positioned in burner fame Lazy burner flame due to improper gas pressure or combustion air | Clean flame sensor if coated or oxidized Inspect for proper flame sensor alignment Check inlet air piping for blockage, proper length, elbows, and termination Compare current gas pressure to rating plate and adjust as needed |
| Furnace fails to operate | EE7 | Problem with igniter circuit Improperly connected or shorted igniter Poor unit ground Igniter relay fault on integrated control module | Check and correct wiring from integrated control module to igniter Diagnose and replace shorted igniter as needed Verify and correct unit ground wiring if needed Check igniter output from control, replace if necessary |
| Furnace fails to operate on high stage; furnace operates normally on low stage Induced draft blower operating | EE8 | High stage pressure switch circuit is closed at start of heating cycle. High stage pressure switch contacts sticking Shorts in pressure switch circuit wiring | Diagnose and replace high stage pressure switch if needed Repair short in wiring |
| Furnace fails to operate on high stage; furnace operates normally on low stage Induced draft blower operating | EE9 | High stage pressure switch circuit is not closed Furnace is operating on low stage only | Inspect pressure switch hose, repair/replace if necessary Inspect flue and/or inlet air piping for blockage, proper length, elbows, and termination Check drain system, correct as necessary Check induced draft blower performance, correct as necessary Tighten or correct wiring connection |
| Furnace fails to operate | EEA | Polarity of 115 volt AC is reversed Poor unit ground | Correct polarity, check and correct wiring if necessary Verify proper ground, correct if necessary |
| Furnace fails to operate | EEb | Gas valve is not energized when it should be External Gas Valve Error | Check wiring in gas valve circuit Replace integrated control board |
| Furnace fails to operate | EEc | Gas valve is energized when it should not be Internal gas valve error | Check wiring in gas valve circuit Replace integrated control board |

TROUBLESHOOTING

| Symptom | LED Status | Fault Description | Corrective Actions |
|--------------------------|------------------|--|--|
| Furnace fails to operate | EE \mathcal{D} | Aux limit switch open (blower compartment) | <p>Check filters and ductwork for blockage, clean filters or remove obstruction</p> <p>Check circulator blower speed and performance, correct speed or replace blower motor if necessary</p> <p>Tighten or correct wiring connection</p> |
| Furnace fails to operate | EE \mathcal{F} | Aux switch (condensate switch) open | Check evaporator drain pan, trap, piping |

Fault Code Recall

Accessing the furnace's diagnostic menu provides access to the last six faults detected by the furnace. Faults are stored most recent to least recent, Any consecutively repeated fault is stored a maximum of three times. Example: A clogged return air filter causes the furnace limit to trip repeatedly. The control will only store this fault the first three consecutive times the fault occurs. **NOTE: It is highly recommended that the fault history be cleared when performing maintenance or servicing the furnace.**

WIRING DIAGRAMS

HIGH VOLTAGE!
DISCONNECT ALL POWER BEFORE SERVICING OR INSTALLING THIS UNIT. MULTIPLE POWER SOURCES MAY BE PRESENT. FAILURE TO DO SO MAY CAUSE PROPERTY DAMAGE, PERSONAL INJURY OR DEATH.

WARNING

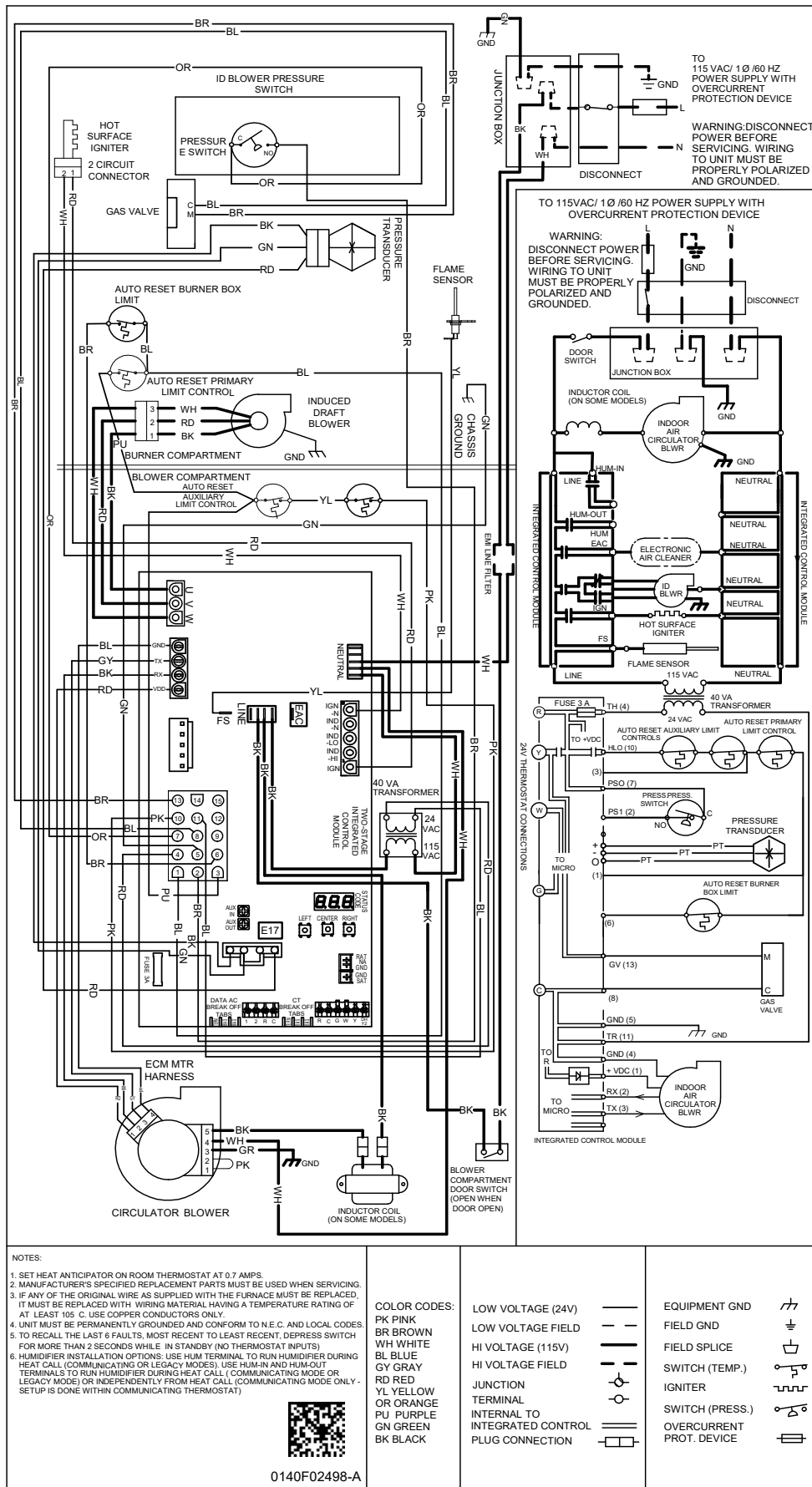

- NOTES:**
1. SET HEAT ANTICIPATOR ON ROOM THERMOSTAT AT 0.7 AMPS.
 2. MANUFACTURER'S SPECIFIED REPLACEMENT PARTS MUST BE USED WHEN SERVICING.
 3. IF ANY OF THE ORIGINAL WIRE AS SUPPLIED WITH THE FURNACE MUST BE REPLACED, IT MUST BE REPLACED WITH WIRING MATERIAL HAVING A TEMPERATURE RATING OF AT LEAST 105 °C. USE COPPER CONDUCTORS ONLY.
 4. UNIT MUST BE PERMANENTLY GROUNDING AND CONFORM TO N.E.C. AND LOCAL CODES.
 5. TO RECALL THE LAST 6 FAULTS, MOST RECENT TO LEAST RECENT, DEPRESS SWITCH FOR MORE THAN 2 SECONDS WHILE IN STANDBY (NO THERMOSTAT INPUTS).
 6. HUMIDIFIER INSTALLATION OPTIONS: USE HUM TERMINAL TO RUN HUMIDIFIER DURING HEAT CALL (COMMUNICATING OR LEGACY MODES). USE HUM-IN AND HUM-OUT TERMINALS TO RUN HUMIDIFIER DURING HEAT CALL (COMMUNICATING MODE OR LEGACY MODE) OR INDEPENDENTLY FROM HEAT CALL (COMMUNICATING MODE ONLY - SETUP IS DONE WITHIN COMMUNICATING THERMOSTAT).

COLOR CODES:
 PK PINK
 BR BROWN
 WH WHITE
 BL BLUE
 GY GRAY
 RD RED
 YL YELLOW
 OR ORANGE
 PU PURPLE
 GN GREEN
 BK BLACK

LOW VOLTAGE (24V)
 LOW VOLTAGE FIELD
HI VOLTAGE (115V)
 HI VOLTAGE FIELD
 JUNCTION
 TERMINAL
 INTERNAL TO INTEGRATED CONTROL
 PLUG CONNECTION

EQUIPMENT GND
FIELD GND
FIELD SPLICE
SWITCH (TEMP.)
IGNITER
SWITCH (PRESS.)
OVERCURRENT PROT. DEVICE

0140F02498-A

Wiring is subject to change. Always refer to the wiring diagram on the unit for the most up-to-date wiring.

CUSTOMER FEEDBACK

We are very interested in all product comments.

Please fill out the feedback form on one of the following links:

Goodman® Brand Products: (<http://www.goodmanmfg.com/about/contact-us>).

Amana® Brand Products: (<http://www.amana-hac.com/about-us/contact-us>).

You can also scan the QR code on the right for the product brand you purchased to be directed to the feedback page.



GOODMAN® BRAND



AMANA® BRAND

Amana is a registered trademark of Maytag Corporation or its related companies and is used under license.

All rights reserved.

Copyright © 2020 Goodman Manufacturing Company, L.P.