



SERVICE MANUAL

Indoor Unit

MODELS:

FLEXX24HP230V1BH
FLEXX36HP230V1BH
FLEXX48HP230V1BH
FLEXX60HP230V1BH

Outdoor Unit

MODELS:

FLEXX36HP230V1AO
FLEXX60HP230V1AO

Thank you for choosing our product.
Please read this Installation & Owner's Manual carefully before
operation and retain it for future reference.



If you lose this Manual, please contact your local distributor or
visit www.greecomfort.com/resources now to download and
file the electronic version.

Foreword

Thank you for choosing Gree air conditioner/heat pumps. In order to correctly install and use our units, and for the satisfactory operation effect, please read this manual carefully.

This manual specifies safe operation requirements from perspectives of product introduction, control, troubleshooting and maintenance, as well as basic principles and implementation methods. Professional operators must abide by relevant national (local) safety requirements and technical specifications set forth in this manual during operations; otherwise, the air conditioning system may fail or be damaged, and personnel safety accident may also occur.

Safety Notice

	Before using the air conditioner, please first read the instruction manual.
	Before installing the air conditioner, please first read the instruction manual.
	Before repairing the air conditioner, please first read the technical service manual.

CONTENTS

1 Product Introduction	3
1.1 Lists of Units	3
1.2 Electrical Parameters	5
2 Control	6
2.1 Operation Mode	6
2.2 Control Mode	8
2.3 Functions	10
3 Troubleshooting.....	14
3.1 Wiring Diagrams	14
3.2 PCB Layout.....	17
3.3 Error Code	25
3.4 Troubleshooting	26
3.5 Failures Not Caused by Errors	53
4 Maintenance	55
4.1 System Diagram	55
4.2 Connection Pipe Vacuum Pumping	55
4.3 Refrigerant Charging.....	57
4.4 Maintenance of Major Components.....	59
4.5 Removal of Major Components.....	69
4.6 Explosive View and Lists of Parts.....	104
Appendices	110
1 Resistance/Temperature Lists of Temperature Sensors	110
1.1 Voltage List of 15 K Ω Temperature Sensors.....	110
1.2 Voltage List of 20 K Ω Pipeline Temperature Sensors	112
1.3 Voltage List of 50 K Ω Discharge Temperature Sensors	114
2 Temperature/Pressure List of Refrigerant	117
3 Operation Tools	117

Safety Notice on Maintenance



PROHIBITED:

- (1) Do not pierce or burn.
- (2) Please note that refrigerant may be odorless.
- (3) The appliance shall be stored in a room without continuously operating ignition sources (For example: open flames, an operating gas appliance or an operating electric heater).
- (4) Indoor unit adopts special joints that can't be detached. The installation method is the same with the common joints. However, because the joint can't be detached, if it is badly connected and causes leakage, it needs to be cut and replaced by a new one through welding.
- (5) Using unsuitable parts or tools may lead to electric shock or fire hazard.
- (6) If refrigerant leaks during maintenance, please ventilate the room immediately. Heavy leakage may lead to breathing difficulty, severe injury or death.
- (7) Disconnect power before disassembling the appliance for maintenance.
- (8) The appliance should be maintained and cared by authorized technical personnel with necessary qualifications.



WARNING:

- (1) If the working place is more than 2m's high, please wear a safety helmet, gloves and a safety belt.
- (2) Never mix any other substances except the specified refrigerant into the refrigerant circuit.
- (3) When re-locating the appliance, check whether the new location is strong enough to withstand the weight of the appliance.
- (4) If there is refrigerant leak, please fix the leak before charging in the refrigerant. After refrigerant is charged, check for refrigerant leaks. If you cannot spot the leak, stop the maintenance work. Please evacuate the system and close the service valve to prevent refrigerant leaking into the room.
- (5) Prepare suitable tools and protectors.
- (6) If you need to carry out maintenance or check the electric circuit without cutting off the power, please be careful not to touch the electrical parts.



NOTICE:

- (1) If the appliance is maintained at a humid place, it should be grounded to avoid electric shock.
- (2) Never repair the unit with wet hands. Operating the unit with wet hands may lead to electric shock.
- (3) If the unit is not correctly grounded, please check and fix it.
- (4) Before cleaning the unit, please disconnect power to prevent the inner fan from starting up and running at

high speed; Otherwise personal injury may occur.

- (5) Measure the insulation resistance after maintenance. The resistance must be 1M or higher. Bad insulation may lead to electric shock.
- (6) Welding and cutting work must be done in a well-ventilated place.
- (7) Gas appliances, heaters and other fire sources should be kept away from the installation and maintenance site.
- (8) Maintenance should be done according to suggestions of the manufacturer.
- (9) Maintenance should be done only after the refrigerant is completely reclaimed from the unit.

**OBSERVED:**

- (1) After the maintenance work is done, check the drainage of indoor unit.
- (2) Do not tilt the unit, otherwise, water may spill out from the unit and make the floor and furniture wet.
- (3) Disassembly of the unit, handling of the refrigerant, oil and accessories should all be done according to applicable local rules and regulations.

Safety Notice on Operation

**PROHIBITED:**

- (1) Never try to modify the unit, otherwise, it may cause electric shock, overheat or fire hazard.
- (2) If the power cord or conducting wires are scratched, please replace them.
- (3) Never use connected or extended power cord or share the power socket with other appliances.
- (4) Prepare a specialized power circuit for the appliance.

**WARNING:**

- (1) If the power plug is dirty, please clean it before inserting it to the power socket. If the power plug is loose, please tighten it up.
- (2) Do not damage the power cord. A damaged or refitted power cord may lead to electric shock or fire hazard.
- (3) Check frequently whether the appliance is in good condition.



**NOTICE:**

- (1) After changing the batteries of remote control, please discard them to avoid being swallowed by children.
- (2) When the unit is working, do not remove the fan cover.
- (3) Do not use organic solvents to wipe the controller operating panel.
- (4) Before cleaning the unit, cut off the power supply.





1 Product Introduction

1.1 Lists of Units

1.1.1 List of Outdoor Units

Model	Power Supply	Finished Product Code	Appearance
	V/Ph/Hz		
FLEXX36HP230V1AO	208/230V-1Ph-60Hz	CF090W1530	
FLEXX60HP230V1AO	208/230V-1Ph-60Hz	CF090W1820	

1.1.2 List of Indoor Units

Model		Cooling/Heating Capacity (Btu/h)	Power Supply	Finished Product Code	Appearance
			V/Ph/Hz		
Airhandler	FLEXX24HP230V1BH	24000/24000	208/230V-1Ph-60Hz	EH010N0040	
Airhandler	FLEXX36HP230V1AH	36000/36000	208/230V-1Ph-60Hz	EM116N0890	
Airhandler	FLEXX48HP230V1AH	48000/48000	208/230V-1Ph-60Hz	EH010N0050	
Airhandler	FLEXX60HP230V1AH	54000/54000	208/230V-1Ph-60Hz	EH010N0031	

NOTE: 1 Ton =12000Btu/h = 3.517kW

1.2 Electrical Parameters

Model	Power supply	Circuit breaker capacity
	V/Ph/Hz	A
FLEXX36HP230V1AO	208/230V-1Ph-60Hz	35
FLEXX60HP230V1AO	208/230V-1Ph-60Hz	45

Model	Power Supply	Fuse Capacity	Circuit Breaker Capacity
	V/Ph/Hz	A	A
FLEXX24HP230V1BH	208/230V-1Ph-60Hz	3.15	15
FLEXX36HP230V1BH	208/230V-1Ph-60Hz	3.15	15
FLEXX48HP230V1BH	208/230V-1Ph-60Hz	3.15	15
FLEXX60HP230V1BH	208/230V-1Ph-60Hz	3.15	15

2 Control

2.1 Operation Mode

2.1.1 Cooling Mode

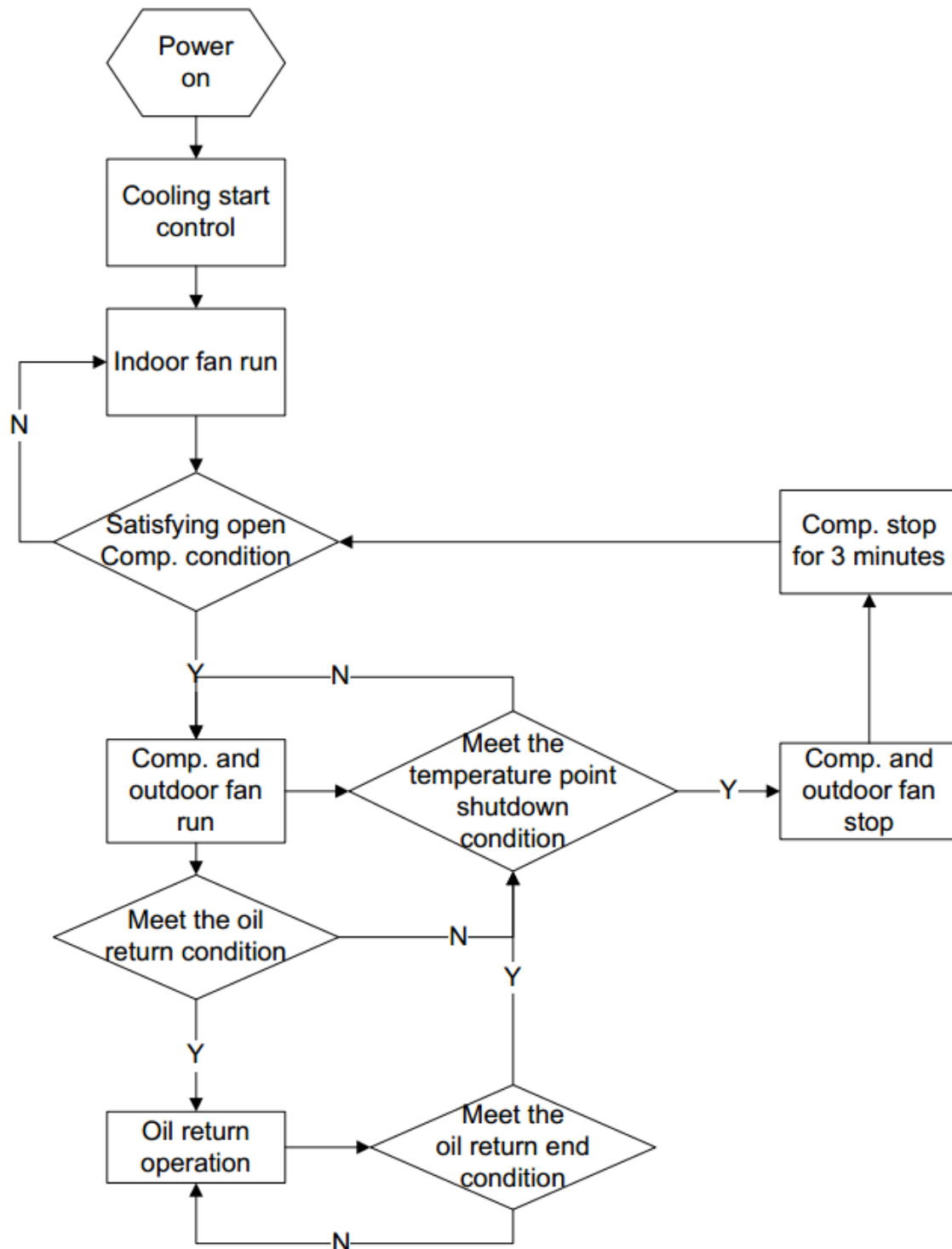

2.1.2 Heating Mode

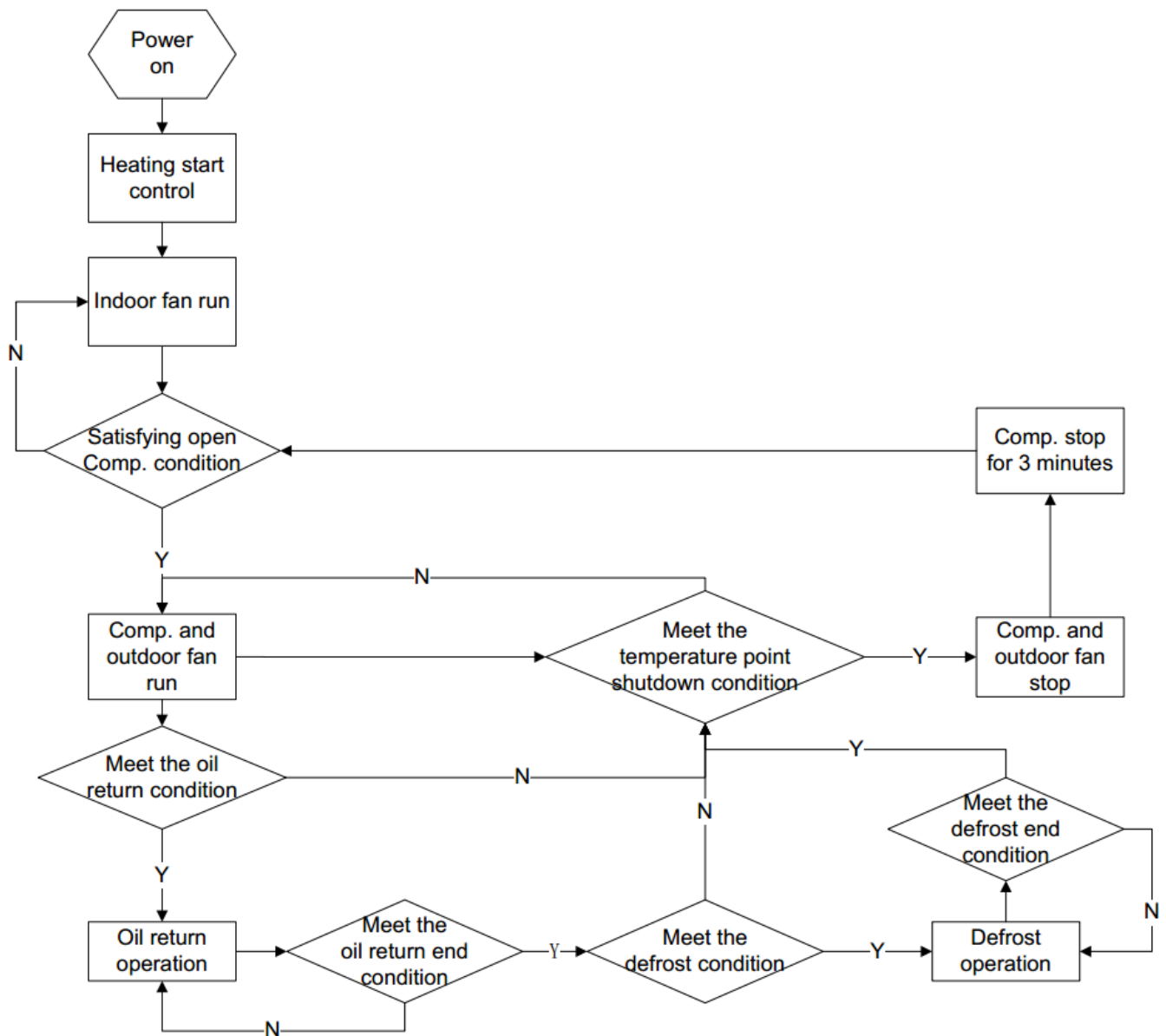

2.2 Control Mode

2.2.1 Based Control

2.2.1.1 Compressor Control

When cooling or heating mode is turned on, indoor fan will run for a while before the compressor starts. Under different modes, the compressor can only be stopped after running for some time (special cases excluded). This is to protect the compressor from frequent start or stop. Once the compressor is stopped, it must not be restarted right away. Please wait for a few minutes.

2.2.1.2 EXV Control

When the unit is first started, the electronic expansion valve will reset control. During the process, the expansion valve will produce rattling sound. When cooling or heating mode is turned on, the valve will be open at a certain step before the compressor starts.

2.2.1.3 Outdoor Fan Control

This series air conditioner has two types of outdoor units: one with a single fan and the other with double fans. The outdoor fan can run at the highest level 10 and the lowest level 1. By controlling the speed of outdoor fan, the unit can achieve cooling at low temperature and heating at high temperature. In fan mode, outdoor fan will not work.

2.2.1.4 4-way Valve Control

After heating mode is turned on for a while, 4-way valve will be energized to change the direction of refrigerant flow so that the system can run in heating and the indoor unit will not blow cold air. Under other modes, the valve will not be energized.

To avoid the 4-way valve from incorrectly changing directions, when the unit stops in heating, due to a temperature point or other protection reasons, the 4-way valve will continue to function temporarily and lose power after a while.

There must be adequate differential pressure for the 4-way valve to change directions.

2.2.2 Special Control

2.2.2.1 Defrosting Control

ODU defrosting control in heating: Defrosting will start when the temperature sensed by outdoor tube temperature sensor reaches a preset value. During defrosting, the 4-way valve will switch to the cooling condition,

and outdoor and indoor fan will both stop. When the temperature sensed by outdoor tube temperature sensor reaches the preset value of defrosting stop, system will quit defrosting. The 4-way valve will switch back to the heating condition, compressor and outdoor unit fan restart.

2.2.2.2 Oil Return Control

If the unit is running at low frequency for a long time, system will enable oil return control. This is to lead oil in the pipeline back to the compressor so that the compressor will not be lack of oil. Generally, the oil return takes about 5min. The compressor running frequency will be raised to the preset oil return frequency.

2.2.3 Protection Control

2.2.3.1 High Pressure Protection Control

System will enable high pressure protection control if the high pressure switch is detected open for continuously a little time. Under high pressure protection, system will be shut down and display error code E1.

When high pressure protection occurs for the first time, system will restore operation if the high pressure switch is detected to be reclosed for continuously a little time. When high pressure protection occurs for the second time in a certain time period, system will not restore operation. You need to manually turn off the unit and clear the error before restarting up the unit. (If high pressure protection occurs frequently, please send for professional personnel to repair.)

2.2.3.2 Low Pressure Protection Control

System will enable low pressure protection control if the low pressure switch is detected open for continuously a little time. Under low pressure protection, system will be shut down and display error code E3. When low pressure protection occurs, system will restore operation if the low pressure switch is detected to be reclosed within a few minutes after shutdown. If low pressure protection occurs for several times in a period of time, system will not restore operation automatically. You need to manually turn off the unit before restarting up the unit.

2.2.3.3 High Temperature Prevention Control

Under heating mode, system will enable high temperature prevention control if the temperature sensed by indoor tube temperature sensor reaches a certain value. When high temperature prevention control is enabled, outdoor fan will slow down.

2.2.3.4 Discharge High Temperature Protection Control

System will enable discharge temperature protection control if the discharge high temperature sensor is

detected open for continuously a little time. Under discharge high temperature protection, system will be shut down and display error code E4. When discharge high temperature protection occurs, system will restore operation if the discharge high temperature sensor is detected to be reclosed within a few minutes after shutdown. If discharge high temperature protection occurs for several times in a period of time, system will not restore operation automatically. You need to manually turn off the unit before restarting up the unit.

2.3 Functions

2.3.1 Set Capacity Dip Switch

Set the capacity of the outdoor unit through the four dip switches of the outdoor unit main control board. Specific dip switch definition, the first dip switch distinguishes the capacity.

Capacity	24K	36K	48K	60K
Dip Switches				

2.3.2 Set Defrost Mode

The second dip switch is selecting the defrost mode.

The second dip switch is used to change the defrost setting, factory default setting is standard defrost. Under extremely low environment temperature, if the standard defrost cannot have the condenser defrosted completely, please set the second dip switch to be strong defrost. Under strong defrost, the defrosting time will be longer, which enable the condenser to be defrosted completely.

Defrost mode	Outdoor unit dip switches
Standard Defrost (Default)	
Strong Defrost	

2.3.3 Set Operating Mode

The third dip switch and the fourth dip switch are selecting the operating mode. Standard mode is the conventional mode.

By setting the strong mode dip switches of the condensing unit, the air conditioner can quickly increase the capacity output and ensure reliable operation in a short time, so as to meet the user's demand for the indoor temperature to quickly reach the set temperature.

Energy saving mode is achieved by setting the condensing unit operating mode to operate the air conditioner within a small load range.

Operating mode	Outdoor unit dip switches												
Standard mode (Default)	<table border="1"> <tr><td colspan="4">SA2</td></tr> <tr><td></td><td></td><td></td><td></td></tr> <tr><td>1</td><td>2</td><td>3</td><td>4</td></tr> </table>	SA2								1	2	3	4
SA2													
1	2	3	4										
Strong mode	<table border="1"> <tr><td colspan="4">SA2</td></tr> <tr><td></td><td></td><td></td><td></td></tr> <tr><td>1</td><td>2</td><td>3</td><td>4</td></tr> </table>	SA2								1	2	3	4
SA2													
1	2	3	4										
Energy saving mode	<table border="1"> <tr><td colspan="4">SA2</td></tr> <tr><td></td><td></td><td></td><td></td></tr> <tr><td>1</td><td>2</td><td>3</td><td>4</td></tr> </table>	SA2								1	2	3	4
SA2													
1	2	3	4										

2.3.3 Set Indoor Fan Speed

Set the indoor fan speed through the eight dip switches of the indoor main control board. The higher level, the higher speed of the indoor unit fan.

Capacity	24K indoor unit dip switches	36K indoor unit dip switches																																																
Level 1	<table border="1"> <tr><td colspan="4">HEAT (SA2)</td><td colspan="4">COOL (SA1)</td></tr> <tr><td></td><td></td><td></td><td></td><td></td><td></td><td></td><td></td></tr> <tr><td>1</td><td>2</td><td>3</td><td>4</td><td>1</td><td>2</td><td>3</td><td>4</td></tr> </table>	HEAT (SA2)				COOL (SA1)												1	2	3	4	1	2	3	4	<table border="1"> <tr><td colspan="4">HEAT (SA2)</td><td colspan="4">COOL (SA1)</td></tr> <tr><td></td><td></td><td></td><td></td><td></td><td></td><td></td><td></td></tr> <tr><td>1</td><td>2</td><td>3</td><td>4</td><td>1</td><td>2</td><td>3</td><td>4</td></tr> </table>	HEAT (SA2)				COOL (SA1)												1	2	3	4	1	2	3	4
HEAT (SA2)				COOL (SA1)																																														
1	2	3	4	1	2	3	4																																											
HEAT (SA2)				COOL (SA1)																																														
1	2	3	4	1	2	3	4																																											
Level 2	<table border="1"> <tr><td colspan="4">HEAT (SA2)</td><td colspan="4">COOL (SA1)</td></tr> <tr><td></td><td></td><td></td><td></td><td></td><td></td><td></td><td></td></tr> <tr><td>1</td><td>2</td><td>3</td><td>4</td><td>1</td><td>2</td><td>3</td><td>4</td></tr> </table>	HEAT (SA2)				COOL (SA1)												1	2	3	4	1	2	3	4	<table border="1"> <tr><td colspan="4">HEAT (SA2)</td><td colspan="4">COOL (SA1)</td></tr> <tr><td></td><td></td><td></td><td></td><td></td><td></td><td></td><td></td></tr> <tr><td>1</td><td>2</td><td>3</td><td>4</td><td>1</td><td>2</td><td>3</td><td>4</td></tr> </table>	HEAT (SA2)				COOL (SA1)												1	2	3	4	1	2	3	4
HEAT (SA2)				COOL (SA1)																																														
1	2	3	4	1	2	3	4																																											
HEAT (SA2)				COOL (SA1)																																														
1	2	3	4	1	2	3	4																																											

Level 3	<table border="1"> <tr><td colspan="4">HEAT (SA2)</td><td colspan="4">COOL (SA1)</td></tr> <tr><td><input type="checkbox"/></td><td><input type="checkbox"/></td><td><input type="checkbox"/></td><td><input type="checkbox"/></td><td><input type="checkbox"/></td><td><input type="checkbox"/></td><td><input type="checkbox"/></td><td><input type="checkbox"/></td></tr> <tr><td>1</td><td>2</td><td>3</td><td>4</td><td>1</td><td>2</td><td>3</td><td>4</td></tr> </table>	HEAT (SA2)				COOL (SA1)				<input type="checkbox"/>	<input type="checkbox"/>	<input type="checkbox"/>	<input type="checkbox"/>	<input type="checkbox"/>	<input type="checkbox"/>	<input type="checkbox"/>	<input type="checkbox"/>	1	2	3	4	1	2	3	4	<table border="1"> <tr><td colspan="4">HEAT (SA2)</td><td colspan="4">COOL (SA1)</td></tr> <tr><td><input type="checkbox"/></td><td><input type="checkbox"/></td><td><input type="checkbox"/></td><td><input type="checkbox"/></td><td><input type="checkbox"/></td><td><input type="checkbox"/></td><td><input type="checkbox"/></td><td><input type="checkbox"/></td></tr> <tr><td>1</td><td>2</td><td>3</td><td>4</td><td>1</td><td>2</td><td>3</td><td>4</td></tr> </table>	HEAT (SA2)				COOL (SA1)				<input type="checkbox"/>	<input type="checkbox"/>	<input type="checkbox"/>	<input type="checkbox"/>	<input type="checkbox"/>	<input type="checkbox"/>	<input type="checkbox"/>	<input type="checkbox"/>	1	2	3	4	1	2	3	4
HEAT (SA2)				COOL (SA1)																																														
<input type="checkbox"/>	<input type="checkbox"/>	<input type="checkbox"/>	<input type="checkbox"/>	<input type="checkbox"/>	<input type="checkbox"/>	<input type="checkbox"/>	<input type="checkbox"/>																																											
1	2	3	4	1	2	3	4																																											
HEAT (SA2)				COOL (SA1)																																														
<input type="checkbox"/>	<input type="checkbox"/>	<input type="checkbox"/>	<input type="checkbox"/>	<input type="checkbox"/>	<input type="checkbox"/>	<input type="checkbox"/>	<input type="checkbox"/>																																											
1	2	3	4	1	2	3	4																																											
Level 4 (Default)	<table border="1"> <tr><td colspan="4">HEAT (SA2)</td><td colspan="4">COOL (SA1)</td></tr> <tr><td><input type="checkbox"/></td><td><input type="checkbox"/></td><td><input type="checkbox"/></td><td><input type="checkbox"/></td><td><input type="checkbox"/></td><td><input type="checkbox"/></td><td><input type="checkbox"/></td><td><input type="checkbox"/></td></tr> <tr><td>1</td><td>2</td><td>3</td><td>4</td><td>1</td><td>2</td><td>3</td><td>4</td></tr> </table>	HEAT (SA2)				COOL (SA1)				<input type="checkbox"/>	<input type="checkbox"/>	<input type="checkbox"/>	<input type="checkbox"/>	<input type="checkbox"/>	<input type="checkbox"/>	<input type="checkbox"/>	<input type="checkbox"/>	1	2	3	4	1	2	3	4	<table border="1"> <tr><td colspan="4">HEAT (SA2)</td><td colspan="4">COOL (SA1)</td></tr> <tr><td><input type="checkbox"/></td><td><input type="checkbox"/></td><td><input type="checkbox"/></td><td><input type="checkbox"/></td><td><input type="checkbox"/></td><td><input type="checkbox"/></td><td><input type="checkbox"/></td><td><input type="checkbox"/></td></tr> <tr><td>1</td><td>2</td><td>3</td><td>4</td><td>1</td><td>2</td><td>3</td><td>4</td></tr> </table>	HEAT (SA2)				COOL (SA1)				<input type="checkbox"/>	<input type="checkbox"/>	<input type="checkbox"/>	<input type="checkbox"/>	<input type="checkbox"/>	<input type="checkbox"/>	<input type="checkbox"/>	<input type="checkbox"/>	1	2	3	4	1	2	3	4
HEAT (SA2)				COOL (SA1)																																														
<input type="checkbox"/>	<input type="checkbox"/>	<input type="checkbox"/>	<input type="checkbox"/>	<input type="checkbox"/>	<input type="checkbox"/>	<input type="checkbox"/>	<input type="checkbox"/>																																											
1	2	3	4	1	2	3	4																																											
HEAT (SA2)				COOL (SA1)																																														
<input type="checkbox"/>	<input type="checkbox"/>	<input type="checkbox"/>	<input type="checkbox"/>	<input type="checkbox"/>	<input type="checkbox"/>	<input type="checkbox"/>	<input type="checkbox"/>																																											
1	2	3	4	1	2	3	4																																											
Level 5	<table border="1"> <tr><td colspan="4">HEAT (SA2)</td><td colspan="4">COOL (SA1)</td></tr> <tr><td><input type="checkbox"/></td><td><input type="checkbox"/></td><td><input type="checkbox"/></td><td><input type="checkbox"/></td><td><input type="checkbox"/></td><td><input type="checkbox"/></td><td><input type="checkbox"/></td><td><input type="checkbox"/></td></tr> <tr><td>1</td><td>2</td><td>3</td><td>4</td><td>1</td><td>2</td><td>3</td><td>4</td></tr> </table>	HEAT (SA2)				COOL (SA1)				<input type="checkbox"/>	<input type="checkbox"/>	<input type="checkbox"/>	<input type="checkbox"/>	<input type="checkbox"/>	<input type="checkbox"/>	<input type="checkbox"/>	<input type="checkbox"/>	1	2	3	4	1	2	3	4	<table border="1"> <tr><td colspan="4">HEAT (SA2)</td><td colspan="4">COOL (SA1)</td></tr> <tr><td><input type="checkbox"/></td><td><input type="checkbox"/></td><td><input type="checkbox"/></td><td><input type="checkbox"/></td><td><input type="checkbox"/></td><td><input type="checkbox"/></td><td><input type="checkbox"/></td><td><input type="checkbox"/></td></tr> <tr><td>1</td><td>2</td><td>3</td><td>4</td><td>1</td><td>2</td><td>3</td><td>4</td></tr> </table>	HEAT (SA2)				COOL (SA1)				<input type="checkbox"/>	<input type="checkbox"/>	<input type="checkbox"/>	<input type="checkbox"/>	<input type="checkbox"/>	<input type="checkbox"/>	<input type="checkbox"/>	<input type="checkbox"/>	1	2	3	4	1	2	3	4
HEAT (SA2)				COOL (SA1)																																														
<input type="checkbox"/>	<input type="checkbox"/>	<input type="checkbox"/>	<input type="checkbox"/>	<input type="checkbox"/>	<input type="checkbox"/>	<input type="checkbox"/>	<input type="checkbox"/>																																											
1	2	3	4	1	2	3	4																																											
HEAT (SA2)				COOL (SA1)																																														
<input type="checkbox"/>	<input type="checkbox"/>	<input type="checkbox"/>	<input type="checkbox"/>	<input type="checkbox"/>	<input type="checkbox"/>	<input type="checkbox"/>	<input type="checkbox"/>																																											
1	2	3	4	1	2	3	4																																											
Level 6	<table border="1"> <tr><td colspan="4">HEAT (SA2)</td><td colspan="4">COOL (SA1)</td></tr> <tr><td><input type="checkbox"/></td><td><input type="checkbox"/></td><td><input type="checkbox"/></td><td><input type="checkbox"/></td><td><input type="checkbox"/></td><td><input type="checkbox"/></td><td><input type="checkbox"/></td><td><input type="checkbox"/></td></tr> <tr><td>1</td><td>2</td><td>3</td><td>4</td><td>1</td><td>2</td><td>3</td><td>4</td></tr> </table>	HEAT (SA2)				COOL (SA1)				<input type="checkbox"/>	<input type="checkbox"/>	<input type="checkbox"/>	<input type="checkbox"/>	<input type="checkbox"/>	<input type="checkbox"/>	<input type="checkbox"/>	<input type="checkbox"/>	1	2	3	4	1	2	3	4	<table border="1"> <tr><td colspan="4">HEAT (SA2)</td><td colspan="4">COOL (SA1)</td></tr> <tr><td><input type="checkbox"/></td><td><input type="checkbox"/></td><td><input type="checkbox"/></td><td><input type="checkbox"/></td><td><input type="checkbox"/></td><td><input type="checkbox"/></td><td><input type="checkbox"/></td><td><input type="checkbox"/></td></tr> <tr><td>1</td><td>2</td><td>3</td><td>4</td><td>1</td><td>2</td><td>3</td><td>4</td></tr> </table>	HEAT (SA2)				COOL (SA1)				<input type="checkbox"/>	<input type="checkbox"/>	<input type="checkbox"/>	<input type="checkbox"/>	<input type="checkbox"/>	<input type="checkbox"/>	<input type="checkbox"/>	<input type="checkbox"/>	1	2	3	4	1	2	3	4
HEAT (SA2)				COOL (SA1)																																														
<input type="checkbox"/>	<input type="checkbox"/>	<input type="checkbox"/>	<input type="checkbox"/>	<input type="checkbox"/>	<input type="checkbox"/>	<input type="checkbox"/>	<input type="checkbox"/>																																											
1	2	3	4	1	2	3	4																																											
HEAT (SA2)				COOL (SA1)																																														
<input type="checkbox"/>	<input type="checkbox"/>	<input type="checkbox"/>	<input type="checkbox"/>	<input type="checkbox"/>	<input type="checkbox"/>	<input type="checkbox"/>	<input type="checkbox"/>																																											
1	2	3	4	1	2	3	4																																											
Level 7	<table border="1"> <tr><td colspan="4">HEAT (SA2)</td><td colspan="4">COOL (SA1)</td></tr> <tr><td><input type="checkbox"/></td><td><input type="checkbox"/></td><td><input type="checkbox"/></td><td><input type="checkbox"/></td><td><input type="checkbox"/></td><td><input type="checkbox"/></td><td><input type="checkbox"/></td><td><input type="checkbox"/></td></tr> <tr><td>1</td><td>2</td><td>3</td><td>4</td><td>1</td><td>2</td><td>3</td><td>4</td></tr> </table>	HEAT (SA2)				COOL (SA1)				<input type="checkbox"/>	<input type="checkbox"/>	<input type="checkbox"/>	<input type="checkbox"/>	<input type="checkbox"/>	<input type="checkbox"/>	<input type="checkbox"/>	<input type="checkbox"/>	1	2	3	4	1	2	3	4	<table border="1"> <tr><td colspan="4">HEAT (SA2)</td><td colspan="4">COOL (SA1)</td></tr> <tr><td><input type="checkbox"/></td><td><input type="checkbox"/></td><td><input type="checkbox"/></td><td><input type="checkbox"/></td><td><input type="checkbox"/></td><td><input type="checkbox"/></td><td><input type="checkbox"/></td><td><input type="checkbox"/></td></tr> <tr><td>1</td><td>2</td><td>3</td><td>4</td><td>1</td><td>2</td><td>3</td><td>4</td></tr> </table>	HEAT (SA2)				COOL (SA1)				<input type="checkbox"/>	<input type="checkbox"/>	<input type="checkbox"/>	<input type="checkbox"/>	<input type="checkbox"/>	<input type="checkbox"/>	<input type="checkbox"/>	<input type="checkbox"/>	1	2	3	4	1	2	3	4
HEAT (SA2)				COOL (SA1)																																														
<input type="checkbox"/>	<input type="checkbox"/>	<input type="checkbox"/>	<input type="checkbox"/>	<input type="checkbox"/>	<input type="checkbox"/>	<input type="checkbox"/>	<input type="checkbox"/>																																											
1	2	3	4	1	2	3	4																																											
HEAT (SA2)				COOL (SA1)																																														
<input type="checkbox"/>	<input type="checkbox"/>	<input type="checkbox"/>	<input type="checkbox"/>	<input type="checkbox"/>	<input type="checkbox"/>	<input type="checkbox"/>	<input type="checkbox"/>																																											
1	2	3	4	1	2	3	4																																											
Level 8	<table border="1"> <tr><td colspan="4">HEAT (SA2)</td><td colspan="4">COOL (SA1)</td></tr> <tr><td><input type="checkbox"/></td><td><input type="checkbox"/></td><td><input type="checkbox"/></td><td><input type="checkbox"/></td><td><input type="checkbox"/></td><td><input type="checkbox"/></td><td><input type="checkbox"/></td><td><input type="checkbox"/></td></tr> <tr><td>1</td><td>2</td><td>3</td><td>4</td><td>1</td><td>2</td><td>3</td><td>4</td></tr> </table>	HEAT (SA2)				COOL (SA1)				<input type="checkbox"/>	<input type="checkbox"/>	<input type="checkbox"/>	<input type="checkbox"/>	<input type="checkbox"/>	<input type="checkbox"/>	<input type="checkbox"/>	<input type="checkbox"/>	1	2	3	4	1	2	3	4	<table border="1"> <tr><td colspan="4">HEAT (SA2)</td><td colspan="4">COOL (SA1)</td></tr> <tr><td><input type="checkbox"/></td><td><input type="checkbox"/></td><td><input type="checkbox"/></td><td><input type="checkbox"/></td><td><input type="checkbox"/></td><td><input type="checkbox"/></td><td><input type="checkbox"/></td><td><input type="checkbox"/></td></tr> <tr><td>1</td><td>2</td><td>3</td><td>4</td><td>1</td><td>2</td><td>3</td><td>4</td></tr> </table>	HEAT (SA2)				COOL (SA1)				<input type="checkbox"/>	<input type="checkbox"/>	<input type="checkbox"/>	<input type="checkbox"/>	<input type="checkbox"/>	<input type="checkbox"/>	<input type="checkbox"/>	<input type="checkbox"/>	1	2	3	4	1	2	3	4
HEAT (SA2)				COOL (SA1)																																														
<input type="checkbox"/>	<input type="checkbox"/>	<input type="checkbox"/>	<input type="checkbox"/>	<input type="checkbox"/>	<input type="checkbox"/>	<input type="checkbox"/>	<input type="checkbox"/>																																											
1	2	3	4	1	2	3	4																																											
HEAT (SA2)				COOL (SA1)																																														
<input type="checkbox"/>	<input type="checkbox"/>	<input type="checkbox"/>	<input type="checkbox"/>	<input type="checkbox"/>	<input type="checkbox"/>	<input type="checkbox"/>	<input type="checkbox"/>																																											
1	2	3	4	1	2	3	4																																											
Capacity	48K indoor unit dip switches	60K indoor unit dip switches																																																
Level 1	<table border="1"> <tr><td colspan="4">HEAT (SA2)</td><td colspan="4">COOL (SA1)</td></tr> <tr><td><input type="checkbox"/></td><td><input type="checkbox"/></td><td><input type="checkbox"/></td><td><input type="checkbox"/></td><td><input type="checkbox"/></td><td><input type="checkbox"/></td><td><input type="checkbox"/></td><td><input type="checkbox"/></td></tr> <tr><td>1</td><td>2</td><td>3</td><td>4</td><td>1</td><td>2</td><td>3</td><td>4</td></tr> </table>	HEAT (SA2)				COOL (SA1)				<input type="checkbox"/>	<input type="checkbox"/>	<input type="checkbox"/>	<input type="checkbox"/>	<input type="checkbox"/>	<input type="checkbox"/>	<input type="checkbox"/>	<input type="checkbox"/>	1	2	3	4	1	2	3	4	<table border="1"> <tr><td colspan="4">HEAT (SA2)</td><td colspan="4">COOL (SA1)</td></tr> <tr><td><input type="checkbox"/></td><td><input type="checkbox"/></td><td><input type="checkbox"/></td><td><input type="checkbox"/></td><td><input type="checkbox"/></td><td><input type="checkbox"/></td><td><input type="checkbox"/></td><td><input type="checkbox"/></td></tr> <tr><td>1</td><td>2</td><td>3</td><td>4</td><td>1</td><td>2</td><td>3</td><td>4</td></tr> </table>	HEAT (SA2)				COOL (SA1)				<input type="checkbox"/>	<input type="checkbox"/>	<input type="checkbox"/>	<input type="checkbox"/>	<input type="checkbox"/>	<input type="checkbox"/>	<input type="checkbox"/>	<input type="checkbox"/>	1	2	3	4	1	2	3	4
HEAT (SA2)				COOL (SA1)																																														
<input type="checkbox"/>	<input type="checkbox"/>	<input type="checkbox"/>	<input type="checkbox"/>	<input type="checkbox"/>	<input type="checkbox"/>	<input type="checkbox"/>	<input type="checkbox"/>																																											
1	2	3	4	1	2	3	4																																											
HEAT (SA2)				COOL (SA1)																																														
<input type="checkbox"/>	<input type="checkbox"/>	<input type="checkbox"/>	<input type="checkbox"/>	<input type="checkbox"/>	<input type="checkbox"/>	<input type="checkbox"/>	<input type="checkbox"/>																																											
1	2	3	4	1	2	3	4																																											
Level 2	<table border="1"> <tr><td colspan="4">HEAT (SA2)</td><td colspan="4">COOL (SA1)</td></tr> <tr><td><input type="checkbox"/></td><td><input type="checkbox"/></td><td><input type="checkbox"/></td><td><input type="checkbox"/></td><td><input type="checkbox"/></td><td><input type="checkbox"/></td><td><input type="checkbox"/></td><td><input type="checkbox"/></td></tr> <tr><td>1</td><td>2</td><td>3</td><td>4</td><td>1</td><td>2</td><td>3</td><td>4</td></tr> </table>	HEAT (SA2)				COOL (SA1)				<input type="checkbox"/>	<input type="checkbox"/>	<input type="checkbox"/>	<input type="checkbox"/>	<input type="checkbox"/>	<input type="checkbox"/>	<input type="checkbox"/>	<input type="checkbox"/>	1	2	3	4	1	2	3	4	<table border="1"> <tr><td colspan="4">HEAT (SA2)</td><td colspan="4">COOL (SA1)</td></tr> <tr><td><input type="checkbox"/></td><td><input type="checkbox"/></td><td><input type="checkbox"/></td><td><input type="checkbox"/></td><td><input type="checkbox"/></td><td><input type="checkbox"/></td><td><input type="checkbox"/></td><td><input type="checkbox"/></td></tr> <tr><td>1</td><td>2</td><td>3</td><td>4</td><td>1</td><td>2</td><td>3</td><td>4</td></tr> </table>	HEAT (SA2)				COOL (SA1)				<input type="checkbox"/>	<input type="checkbox"/>	<input type="checkbox"/>	<input type="checkbox"/>	<input type="checkbox"/>	<input type="checkbox"/>	<input type="checkbox"/>	<input type="checkbox"/>	1	2	3	4	1	2	3	4
HEAT (SA2)				COOL (SA1)																																														
<input type="checkbox"/>	<input type="checkbox"/>	<input type="checkbox"/>	<input type="checkbox"/>	<input type="checkbox"/>	<input type="checkbox"/>	<input type="checkbox"/>	<input type="checkbox"/>																																											
1	2	3	4	1	2	3	4																																											
HEAT (SA2)				COOL (SA1)																																														
<input type="checkbox"/>	<input type="checkbox"/>	<input type="checkbox"/>	<input type="checkbox"/>	<input type="checkbox"/>	<input type="checkbox"/>	<input type="checkbox"/>	<input type="checkbox"/>																																											
1	2	3	4	1	2	3	4																																											
Level 3	<table border="1"> <tr><td colspan="4">HEAT (SA2)</td><td colspan="4">COOL (SA1)</td></tr> <tr><td><input type="checkbox"/></td><td><input type="checkbox"/></td><td><input type="checkbox"/></td><td><input type="checkbox"/></td><td><input type="checkbox"/></td><td><input type="checkbox"/></td><td><input type="checkbox"/></td><td><input type="checkbox"/></td></tr> <tr><td>1</td><td>2</td><td>3</td><td>4</td><td>1</td><td>2</td><td>3</td><td>4</td></tr> </table>	HEAT (SA2)				COOL (SA1)				<input type="checkbox"/>	<input type="checkbox"/>	<input type="checkbox"/>	<input type="checkbox"/>	<input type="checkbox"/>	<input type="checkbox"/>	<input type="checkbox"/>	<input type="checkbox"/>	1	2	3	4	1	2	3	4	<table border="1"> <tr><td colspan="4">HEAT (SA2)</td><td colspan="4">COOL (SA1)</td></tr> <tr><td><input type="checkbox"/></td><td><input type="checkbox"/></td><td><input type="checkbox"/></td><td><input type="checkbox"/></td><td><input type="checkbox"/></td><td><input type="checkbox"/></td><td><input type="checkbox"/></td><td><input type="checkbox"/></td></tr> <tr><td>1</td><td>2</td><td>3</td><td>4</td><td>1</td><td>2</td><td>3</td><td>4</td></tr> </table>	HEAT (SA2)				COOL (SA1)				<input type="checkbox"/>	<input type="checkbox"/>	<input type="checkbox"/>	<input type="checkbox"/>	<input type="checkbox"/>	<input type="checkbox"/>	<input type="checkbox"/>	<input type="checkbox"/>	1	2	3	4	1	2	3	4
HEAT (SA2)				COOL (SA1)																																														
<input type="checkbox"/>	<input type="checkbox"/>	<input type="checkbox"/>	<input type="checkbox"/>	<input type="checkbox"/>	<input type="checkbox"/>	<input type="checkbox"/>	<input type="checkbox"/>																																											
1	2	3	4	1	2	3	4																																											
HEAT (SA2)				COOL (SA1)																																														
<input type="checkbox"/>	<input type="checkbox"/>	<input type="checkbox"/>	<input type="checkbox"/>	<input type="checkbox"/>	<input type="checkbox"/>	<input type="checkbox"/>	<input type="checkbox"/>																																											
1	2	3	4	1	2	3	4																																											
Level 4 (Default)	<table border="1"> <tr><td colspan="4">HEAT (SA2)</td><td colspan="4">COOL (SA1)</td></tr> <tr><td><input type="checkbox"/></td><td><input type="checkbox"/></td><td><input type="checkbox"/></td><td><input type="checkbox"/></td><td><input type="checkbox"/></td><td><input type="checkbox"/></td><td><input type="checkbox"/></td><td><input type="checkbox"/></td></tr> <tr><td>1</td><td>2</td><td>3</td><td>4</td><td>1</td><td>2</td><td>3</td><td>4</td></tr> </table>	HEAT (SA2)				COOL (SA1)				<input type="checkbox"/>	<input type="checkbox"/>	<input type="checkbox"/>	<input type="checkbox"/>	<input type="checkbox"/>	<input type="checkbox"/>	<input type="checkbox"/>	<input type="checkbox"/>	1	2	3	4	1	2	3	4	<table border="1"> <tr><td colspan="4">HEAT (SA2)</td><td colspan="4">COOL (SA1)</td></tr> <tr><td><input type="checkbox"/></td><td><input type="checkbox"/></td><td><input type="checkbox"/></td><td><input type="checkbox"/></td><td><input type="checkbox"/></td><td><input type="checkbox"/></td><td><input type="checkbox"/></td><td><input type="checkbox"/></td></tr> <tr><td>1</td><td>2</td><td>3</td><td>4</td><td>1</td><td>2</td><td>3</td><td>4</td></tr> </table>	HEAT (SA2)				COOL (SA1)				<input type="checkbox"/>	<input type="checkbox"/>	<input type="checkbox"/>	<input type="checkbox"/>	<input type="checkbox"/>	<input type="checkbox"/>	<input type="checkbox"/>	<input type="checkbox"/>	1	2	3	4	1	2	3	4
HEAT (SA2)				COOL (SA1)																																														
<input type="checkbox"/>	<input type="checkbox"/>	<input type="checkbox"/>	<input type="checkbox"/>	<input type="checkbox"/>	<input type="checkbox"/>	<input type="checkbox"/>	<input type="checkbox"/>																																											
1	2	3	4	1	2	3	4																																											
HEAT (SA2)				COOL (SA1)																																														
<input type="checkbox"/>	<input type="checkbox"/>	<input type="checkbox"/>	<input type="checkbox"/>	<input type="checkbox"/>	<input type="checkbox"/>	<input type="checkbox"/>	<input type="checkbox"/>																																											
1	2	3	4	1	2	3	4																																											
Level 5	<table border="1"> <tr><td colspan="4">HEAT (SA2)</td><td colspan="4">COOL (SA1)</td></tr> <tr><td><input type="checkbox"/></td><td><input type="checkbox"/></td><td><input type="checkbox"/></td><td><input type="checkbox"/></td><td><input type="checkbox"/></td><td><input type="checkbox"/></td><td><input type="checkbox"/></td><td><input type="checkbox"/></td></tr> <tr><td>1</td><td>2</td><td>3</td><td>4</td><td>1</td><td>2</td><td>3</td><td>4</td></tr> </table>	HEAT (SA2)				COOL (SA1)				<input type="checkbox"/>	<input type="checkbox"/>	<input type="checkbox"/>	<input type="checkbox"/>	<input type="checkbox"/>	<input type="checkbox"/>	<input type="checkbox"/>	<input type="checkbox"/>	1	2	3	4	1	2	3	4	<table border="1"> <tr><td colspan="4">HEAT (SA2)</td><td colspan="4">COOL (SA1)</td></tr> <tr><td><input type="checkbox"/></td><td><input type="checkbox"/></td><td><input type="checkbox"/></td><td><input type="checkbox"/></td><td><input type="checkbox"/></td><td><input type="checkbox"/></td><td><input type="checkbox"/></td><td><input type="checkbox"/></td></tr> <tr><td>1</td><td>2</td><td>3</td><td>4</td><td>1</td><td>2</td><td>3</td><td>4</td></tr> </table>	HEAT (SA2)				COOL (SA1)				<input type="checkbox"/>	<input type="checkbox"/>	<input type="checkbox"/>	<input type="checkbox"/>	<input type="checkbox"/>	<input type="checkbox"/>	<input type="checkbox"/>	<input type="checkbox"/>	1	2	3	4	1	2	3	4
HEAT (SA2)				COOL (SA1)																																														
<input type="checkbox"/>	<input type="checkbox"/>	<input type="checkbox"/>	<input type="checkbox"/>	<input type="checkbox"/>	<input type="checkbox"/>	<input type="checkbox"/>	<input type="checkbox"/>																																											
1	2	3	4	1	2	3	4																																											
HEAT (SA2)				COOL (SA1)																																														
<input type="checkbox"/>	<input type="checkbox"/>	<input type="checkbox"/>	<input type="checkbox"/>	<input type="checkbox"/>	<input type="checkbox"/>	<input type="checkbox"/>	<input type="checkbox"/>																																											
1	2	3	4	1	2	3	4																																											

Capacity	48K indoor unit dip switches	60K indoor unit dip switches																																																
Level 6	<table border="1"> <tr> <td colspan="4">HEAT (SA2)</td> <td colspan="4">COOL (SA1)</td> </tr> <tr> <td></td><td></td><td></td><td></td> <td></td><td></td><td></td><td></td> </tr> <tr> <td>1</td><td>2</td><td>3</td><td>4</td> <td>1</td><td>2</td><td>3</td><td>4</td> </tr> </table>	HEAT (SA2)				COOL (SA1)												1	2	3	4	1	2	3	4	<table border="1"> <tr> <td colspan="4">HEAT (SA2)</td> <td colspan="4">COOL (SA1)</td> </tr> <tr> <td></td><td></td><td></td><td></td> <td></td><td></td><td></td><td></td> </tr> <tr> <td>1</td><td>2</td><td>3</td><td>4</td> <td>1</td><td>2</td><td>3</td><td>4</td> </tr> </table>	HEAT (SA2)				COOL (SA1)												1	2	3	4	1	2	3	4
HEAT (SA2)				COOL (SA1)																																														
1	2	3	4	1	2	3	4																																											
HEAT (SA2)				COOL (SA1)																																														
1	2	3	4	1	2	3	4																																											
Level 7	<table border="1"> <tr> <td colspan="4">HEAT (SA2)</td> <td colspan="4">COOL (SA1)</td> </tr> <tr> <td></td><td></td><td></td><td></td> <td></td><td></td><td></td><td></td> </tr> <tr> <td>1</td><td>2</td><td>3</td><td>4</td> <td>1</td><td>2</td><td>3</td><td>4</td> </tr> </table>	HEAT (SA2)				COOL (SA1)												1	2	3	4	1	2	3	4	<table border="1"> <tr> <td colspan="4">HEAT (SA2)</td> <td colspan="4">COOL (SA1)</td> </tr> <tr> <td></td><td></td><td></td><td></td> <td></td><td></td><td></td><td></td> </tr> <tr> <td>1</td><td>2</td><td>3</td><td>4</td> <td>1</td><td>2</td><td>3</td><td>4</td> </tr> </table>	HEAT (SA2)				COOL (SA1)												1	2	3	4	1	2	3	4
HEAT (SA2)				COOL (SA1)																																														
1	2	3	4	1	2	3	4																																											
HEAT (SA2)				COOL (SA1)																																														
1	2	3	4	1	2	3	4																																											
Level 8	<table border="1"> <tr> <td colspan="4">HEAT (SA2)</td> <td colspan="4">COOL (SA1)</td> </tr> <tr> <td></td><td></td><td></td><td></td> <td></td><td></td><td></td><td></td> </tr> <tr> <td>1</td><td>2</td><td>3</td><td>4</td> <td>1</td><td>2</td><td>3</td><td>4</td> </tr> </table>	HEAT (SA2)				COOL (SA1)												1	2	3	4	1	2	3	4	<table border="1"> <tr> <td colspan="4">HEAT (SA2)</td> <td colspan="4">COOL (SA1)</td> </tr> <tr> <td></td><td></td><td></td><td></td> <td></td><td></td><td></td><td></td> </tr> <tr> <td>1</td><td>2</td><td>3</td><td>4</td> <td>1</td><td>2</td><td>3</td><td>4</td> </tr> </table>	HEAT (SA2)				COOL (SA1)												1	2	3	4	1	2	3	4
HEAT (SA2)				COOL (SA1)																																														
1	2	3	4	1	2	3	4																																											
HEAT (SA2)				COOL (SA1)																																														
1	2	3	4	1	2	3	4																																											

NOTE:

- ① After the unit is shut down or stopped at the temperature point, the indoor unit will delay for a few minutes and then shut down. The refrigeration can realize the drying function, relieve the mold of the air duct.
- ② Installation and debugging when attention to verify the switch sequence of electrical heating and fan, ensure the fan must be turned on when electric heating operation, to ensure the electric heating is turned off before the fan.
- ③ During installation and debugging, pay attention to check whether the temperature controller has set the fan delay and shutdown time. If the temperature controller has been set, the actual delay and shutdown time of the fan is equal to the temperature controller setting time plus the fan delay time of the indoor unit.

2.3.6 Forced Defrost Control

Press and hold "SW1" for about 5s to enter the first level menu of the debugging mode, the outdoor unit mainboard LED displayer flashes. Under the first level menu, short press "SW1" to switch various functions. After switching to "06", short press "SW2" or "SW3" to enter the forced defrosting mode, "ON" means open, "OF" means close, and then short press "SW1" to save. During debugging, if no operation is performed within 10s, the debugging mode interface will be exited.

2.3.6 Refrigerant Recovery Control

Press and hold "SW1" for about 5s to enter the first level menu of the debugging mode, the outdoor unit mainboard LED displayer flashes. Under the first level menu, short press "SW1" to switch various functions. After switching to "08", short press "SW2" or "SW3" to enter the refrigerant recovery control mode, "ON" means open, "OF" means close. And then short press "SW1" to save. During debugging, if no operation is performed within 10s, the debugging mode interface will be exited.

2.3.7 Forced Operation Control

Press and hold "SW1" for about 5s to enter the first level menu of the debugging mode, the outdoor unit main board LED displayer flashes. Under the first level menu, short press "SW1" to switch various functions. After switching to "09", short press "SW2" or "SW3" to enter the forced operation control mode, "01" denotes that turn on the forced operation cooling mode; "02" denotes that turn on the forced operation heating mode; "OF" indicates that shut down the forced cooling / heating mode. And then short press "SW1" to save. During debugging, if no operation is performed within 10s, the debugging mode interface will be exited.

2.3.8 Thermostat Functions

Thermostat model: XE70-00/E1, please refer to the thermostat instruction manual for all functions.

3 Troubleshooting

3.1 Wiring Diagrams

The following electric diagram is for reference only. Please refer to diagram stuck on the unit as the latest version.

3.1.1 Wiring Diagrams of ODUS

Model: FLEXX36HP230V1AO

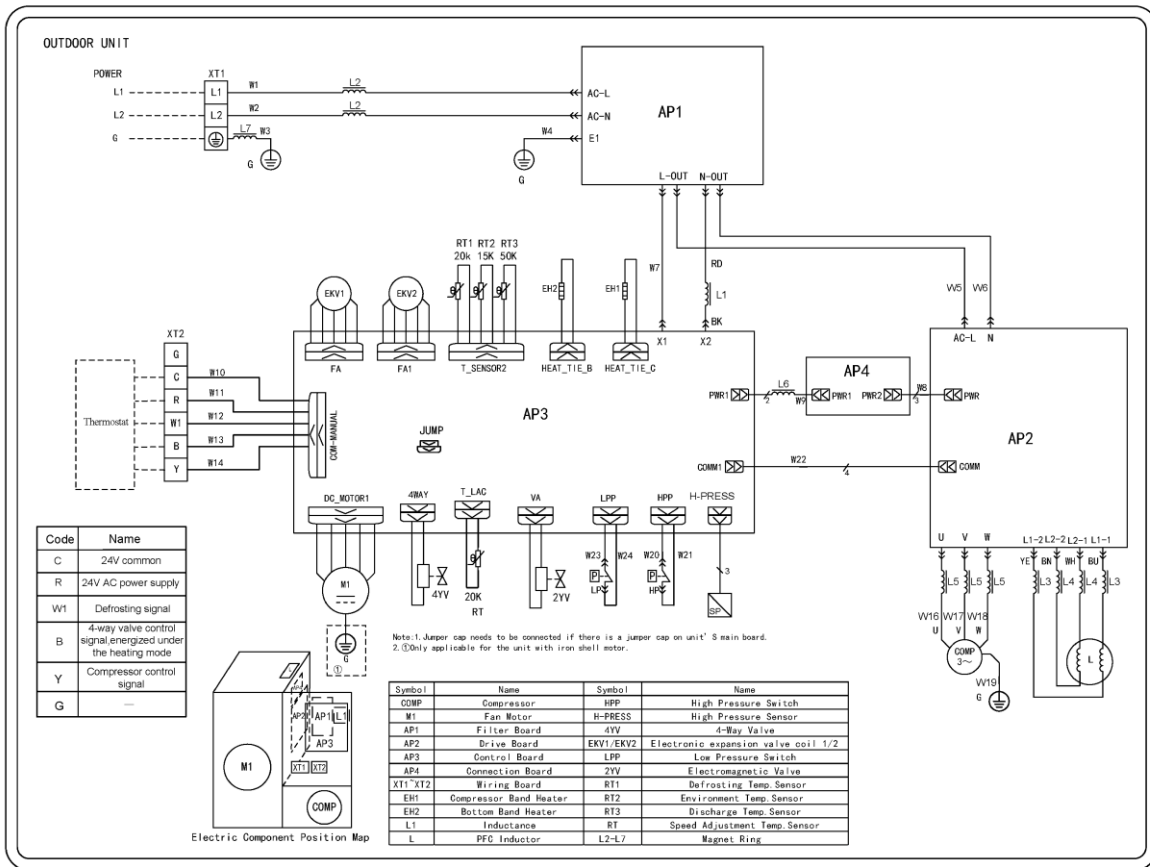

Model:FLEXX60HP230V1AO

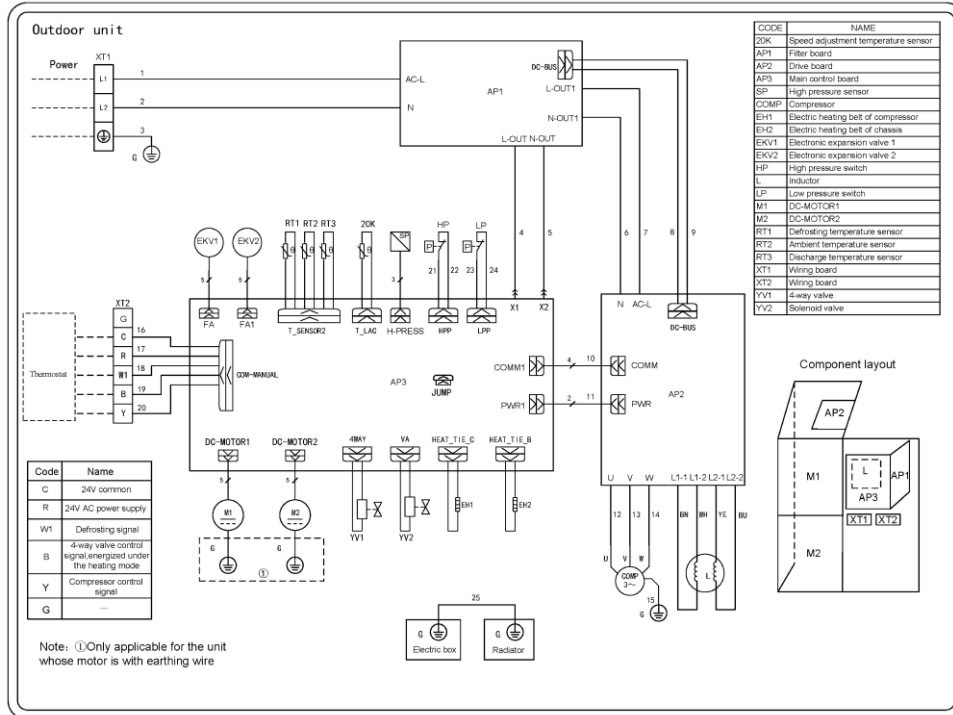

3.1.2 Wiring Diagrams of IDUs

Model: FLEXX24HP230V1BH, FLEXX36HP230V1BH

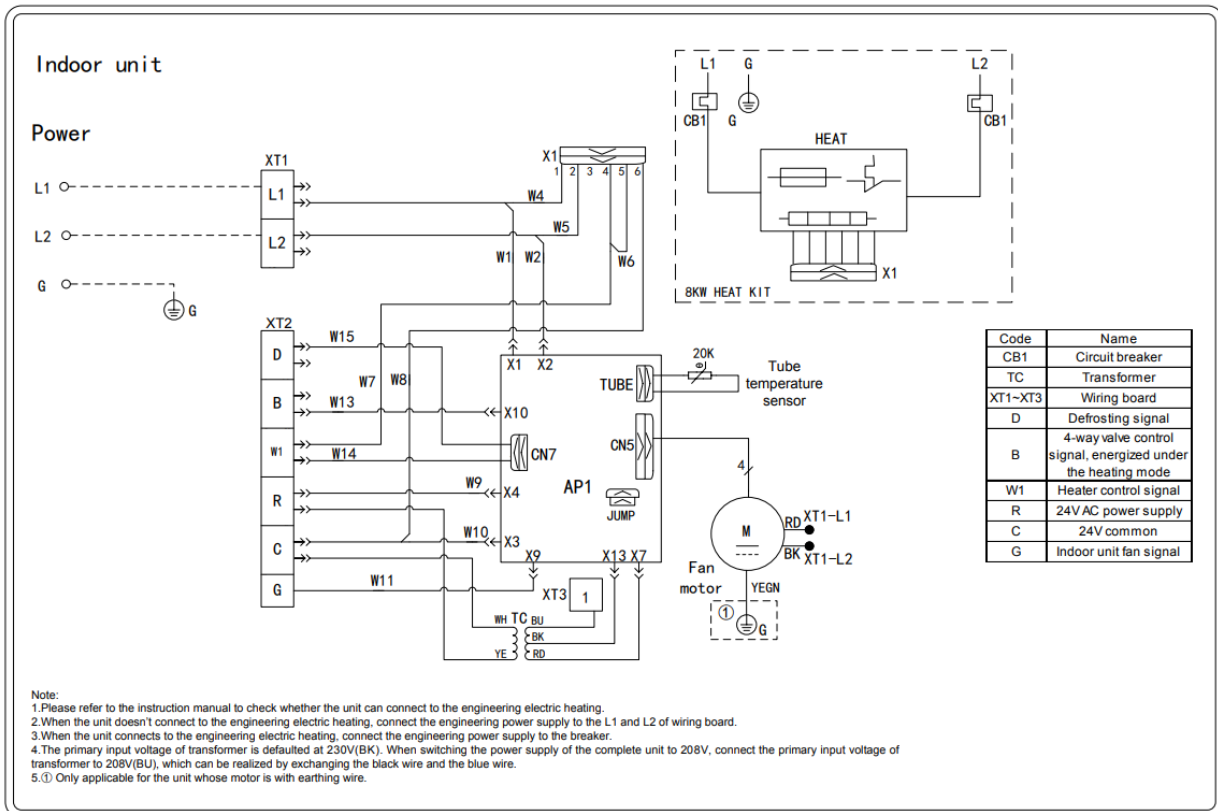

Model: FLEXX48HP230V1BH, FLEXX60HP230V1BH

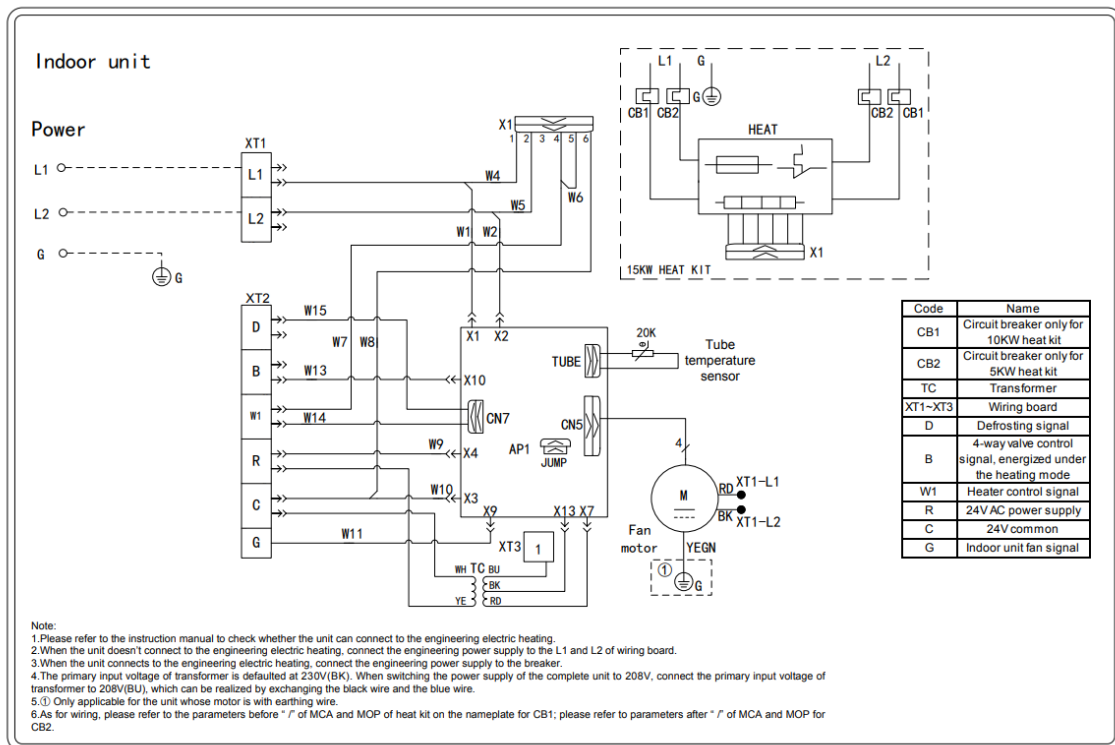

3.2 PCB Layout

3.2.1 Interface

Indoor

unit:

Mainboard

Model: FLEXX24HP230V1BH, FLEXX36HP230V1BH, FLEXX48HP230V1BH, FLEXX24HP230V1BH

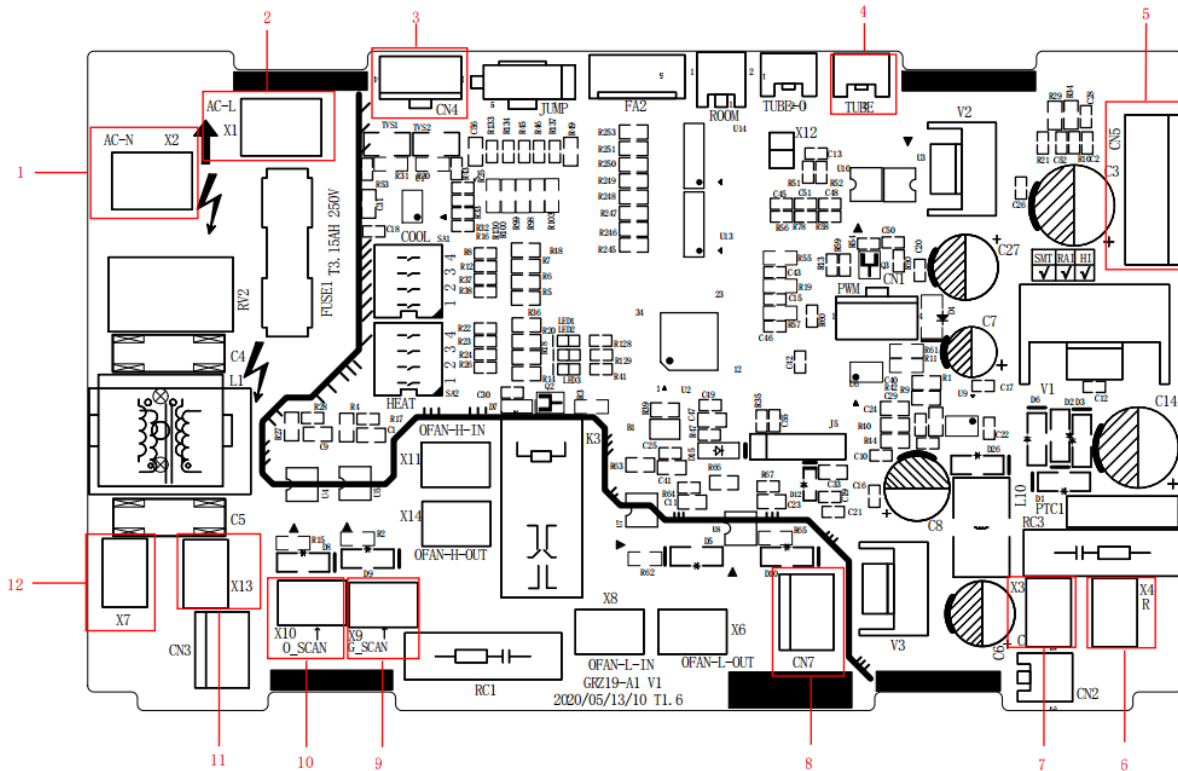

No.	Printing	Interface	No.	Printing	Interface
1	AC-N (X2)	Neutral wire input	7	X3(C)	Transformer Neutral wire output
2	AC-L (X1)	Live wire input	8	CN7	1.electrical heat check 3.defrosting check
3	CN4	Wired control communication interface	9	X9(G_SCAN)	Indoor motor check
4	TUBE	tube temperature sensor interface	10	X10(O_SCAN)	4-Way check
5	CN5	DC motor output	11	X13	Transformer Live wire input
6	X4(R)	Transformer Live wire output	12	X7	Transformer Neutral wire input

Pinboard

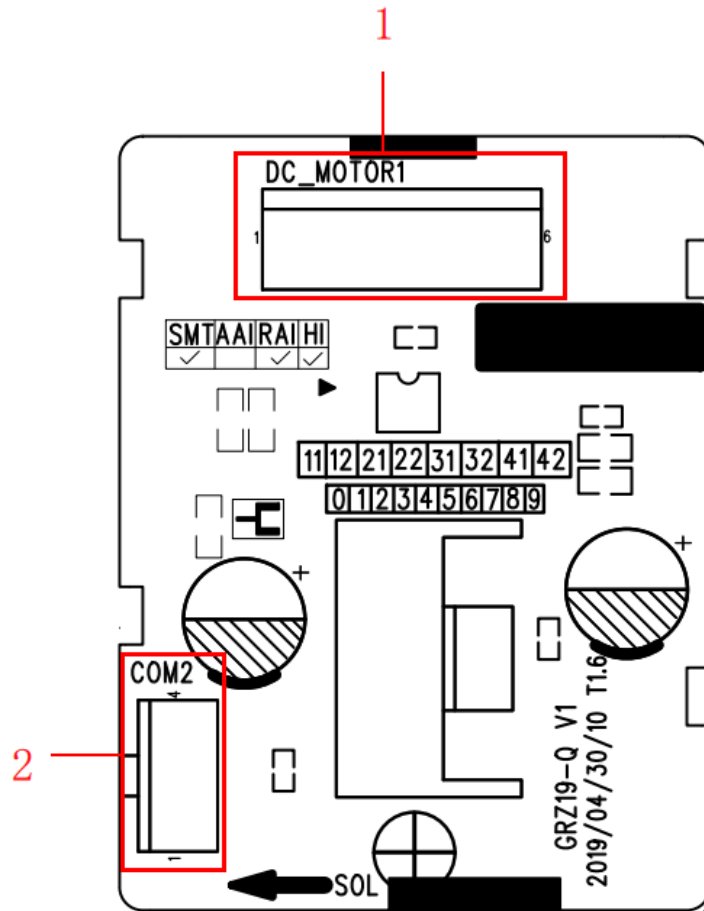

No.	Printing	Interface	No.	Printing	Interface
1	DC-MOTOR1	DC motor output	2	COM2	DC motor control signal input

Outdoor unit:

Model: FLEXX36HP230V1AO, FLEXX60HP230V1AO Mainboard

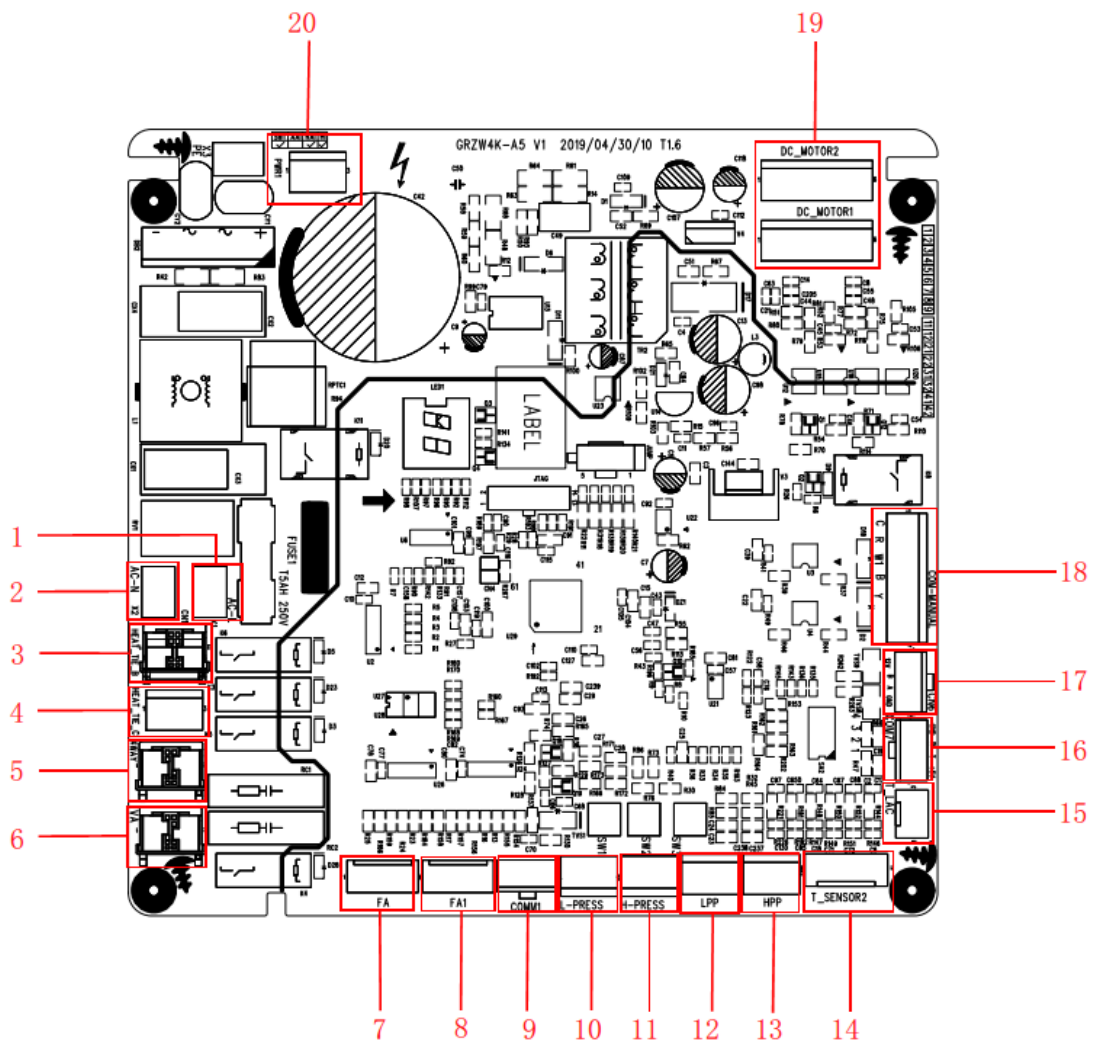

No.	Printing	Interface	No.	Printing	Interface
1	AC-L	Live wire input	11	H-PRESS	High pressure sensor interface
2	AC-N	Neutral wire input	12	LPP	System low pressure protection interface
3	HEAT_TIE_B	Chassis electric heating belt	13	HPP	System high pressure protection interface
4	HEAT_TIE_C	Compressor electric heating belt	14	T_SENSOR2	2. Outdoor tube temperature sensor interface 4. Outdoor ambient temperature sensor interface 6. Discharge temperature sensor interface
5	4WAY	4-way valve	15	T_LAC	Low temperature cooling temperature sensing

No.	Printing	Interface	No.	Printing	Interface
6	VA	Electromagnetic valve interface	16	COM7	Unit communication interface
7	FA	Electronic expansion valve interface	17	CN6	GPRS communication interface
8	FA1	Electronic expansion valve 1 interface Refrigerant heat dissipation	18	COM-MANUAL	Thermostat interface
9	COMM1	Drive communication interface	19	DC_MOTOR1 DC_MOTOR2	DC motor output
10	L-PRESS	Low pressure sensor interface	20	PWR1	310V DC power supply interface

Drive Board:

Model: FLEXX36HP230V1A0

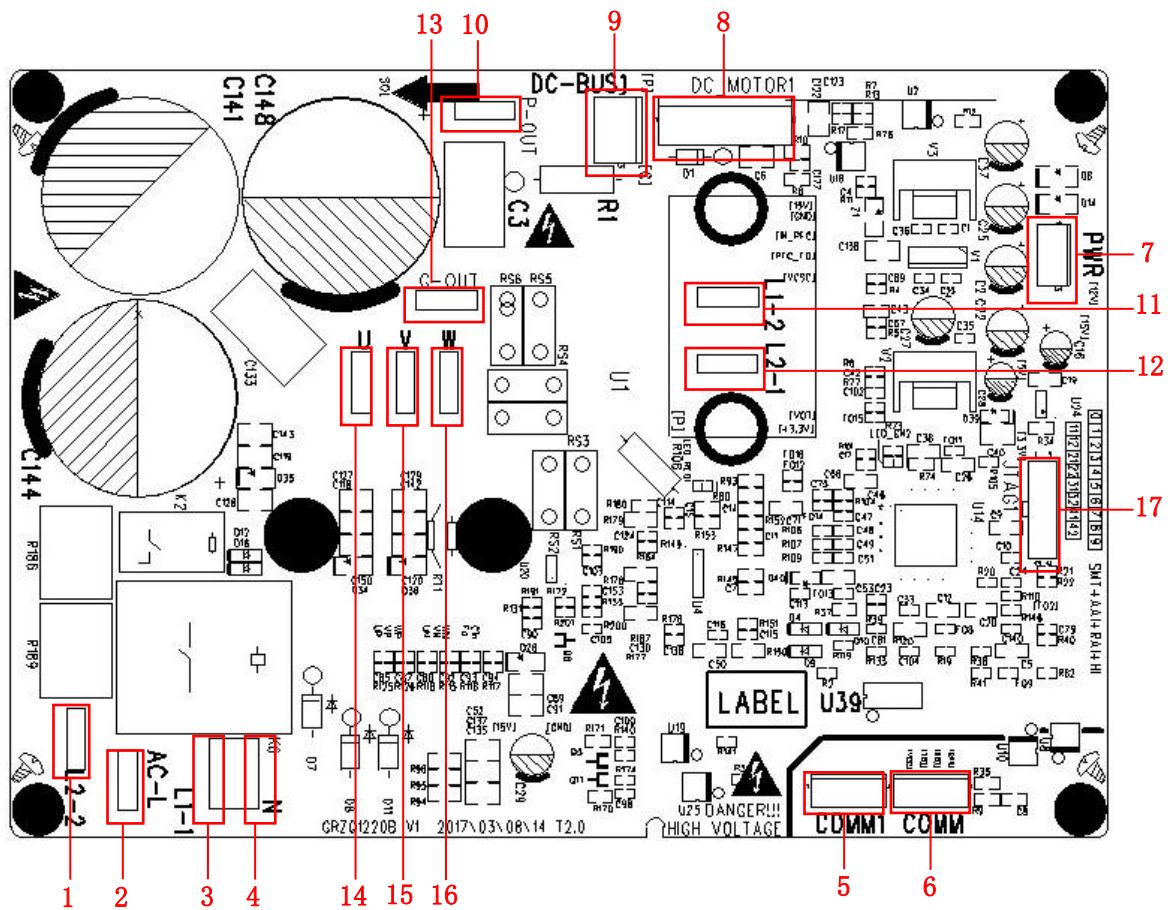

No.	Printing	Interface	No.	Printing	Interface
1	L2-2	PFC induction wire (blue)	10	P-OUT	Reserved
2	AC-L	Live wire	11	L1-2	PFC induction wire (white)
3	L1-1	PFC induction wire (brown)	12	L2-1	PFC induction wire (yellow)
4	N	Neutral wire	13	G-OUT	Reserved
5	COMM1	Communication terminal, same with COMM	14	U	Compressor U phase terminal

No.	Printing	Interface	No.	Printing	Interface
6	COMM	Communication terminal, same with COMM1	15	V	Compressor V phase terminal
7	PWR	Drive power supply terminal	16	W	Compressor W phase terminal
8	DC-MOTOR1	DC fan terminal	17	JTAG1	Programming interface (for testing)
9	DC-BUS1	Power discharge terminal (for testing)	-	-	-

Model: FLEXX60HP230V1AO

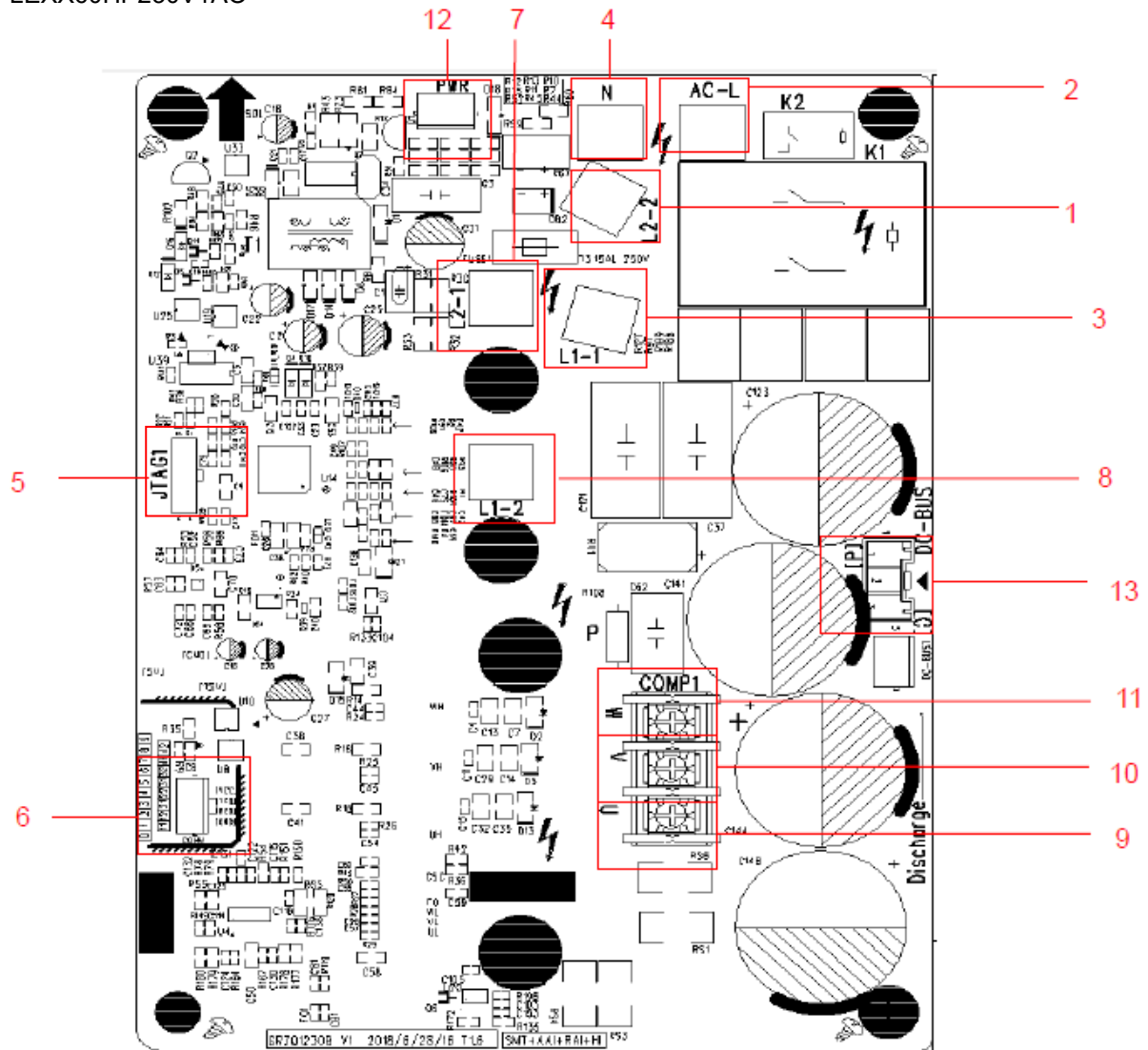

No.	Printing	Interface	No.	Printing	Interface
1	L2-2	PFC induction wire (blue)	8	L1-2	PFC induction wire (white)
2	AC-L	Live wire	9	U	Compressor U phase terminal
3	L1-1	PFC induction wire (brown)	10	V	Compressor V phase terminal
4	N	Neutral wire	11	W	Compressor W phase terminal
5	JTAG1	Programming interface (for testing)	12	PWR	Drive power supply terminal
6	COMM	Communication terminal, same with COMM	13	DC-BUS	Power discharge terminal (for testing)
7	L2-1	PFC induction wire (yellow)	-	-	-

Filtering Board:

Model: FLEXX36HP230V1AO

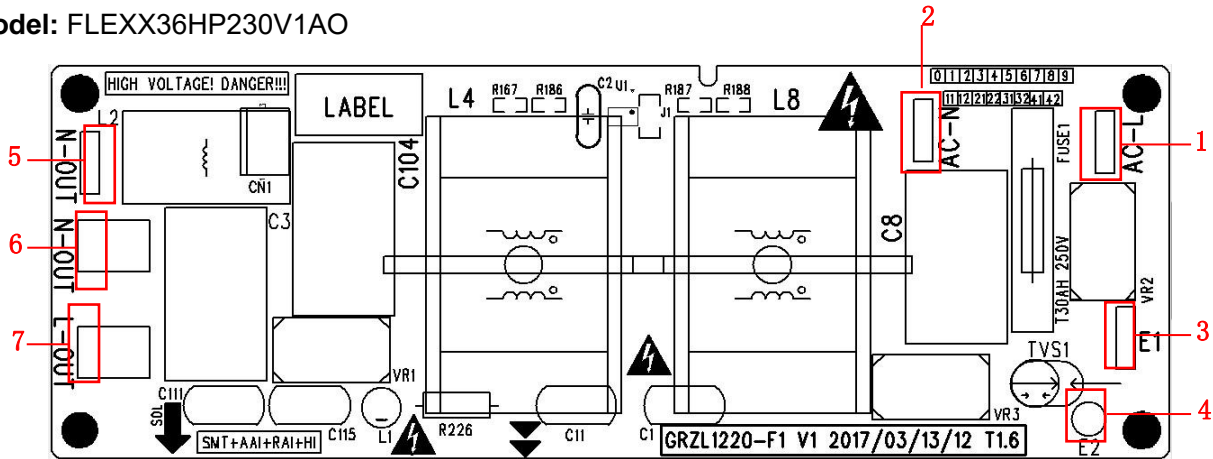

No.	Printing	Interface	No.	Printing	Interface
1	AC-L	Power input live wire terminal	5	N-OUT	Power output neutral wire terminal (reserved)
2	AC-N	Power input neutral wire terminal	6	N-OUT	Power output neutral wire terminal
3	E1	Filtering board ground wire terminal	7	L-OUT	Power output live wire terminal
4	E2	Filtering board grounding hole (reserved)	-	-	-

Model: FLEXX60HP230V1AO

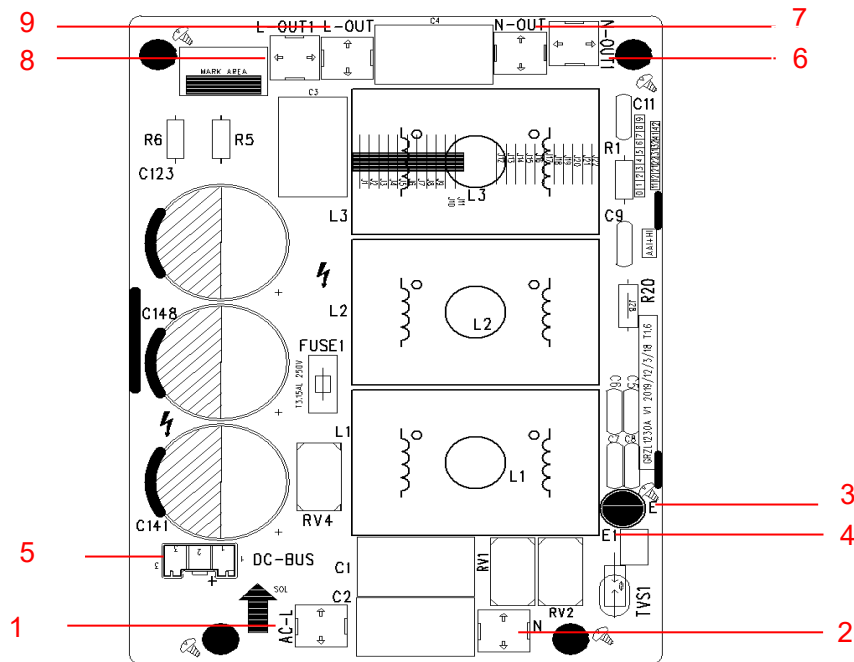

No.	Printing	Interface	No.	Printing	Interface
1	AC-L	Power input live wire terminal	6	N-OUT1	Power output neutral wire terminal (reserved)
2	N	Power input neutral wire terminal	7	N-OUT	Power output neutral wire terminal
3	E	Filtering board ground wire terminal	8	L-OUT1	Power output live wire terminal
4	E1	Filtering board grounding hole (reserved)	9	L-OUT	Power output live wire terminal
5	DC-BUS	Power discharge terminal (for testing)	-	-	-

3.2.2 IPM, PFC Testing Method

3.2.2.1 Method of Testing IPM Module

(1) Preparation before test: prepare a universal meter and turn to its diode option, and then remove the wires U, V, W of the compressor after it is powered off for one minute.

(2) Testing Steps

Step 1: put the black probe on the place P and the red one on the wiring terminal U, V, W respectively as shown in the following figure to measure the voltage between UP, VP and WP.

Step 2: put the red probe on the place N and the black one on the wiring terminal U, V, W respectively as shown in the following figure to measure the voltage between NU, NV and NW.

(3) If the measured voltages between UP, VP, WP, NU, NV, NW are all among 0.3V-0.7V, then it indicates the IPM module is normal; If any measured value is 0, it indicates the IPM is damaged.

3.2.2.2 Method of Testing PFC Module Short Circuit

(1) Preparation before test: prepare a universal meter and turn to its diode option, and then remove the wires L1-2, L2-1 after it is powered off for one minute.

(2) Testing Steps:

Step 1: Put the black probe on the place P and the red one on the wiring terminal L1-2, L2-1 respectively as shown in the following figure to measure the voltage between L1-2 and P; L2-1 and P.

Step 2: Put the red probe on the place N and the black one on the wiring terminal L1-2, L2-1 respectively as shown in the following figure to measure the voltage between N and L1-2; N and L2-1.

(3) If the measured voltages between L1-2 and P; L2-1 and P; N and L1-2; N and L2-1 are all among 0.3V-0.7V, then it indicates the PFC module is normal; If any measured value is 0, it indicates the PFC is damaged.

FLEXX36HP230V1AO

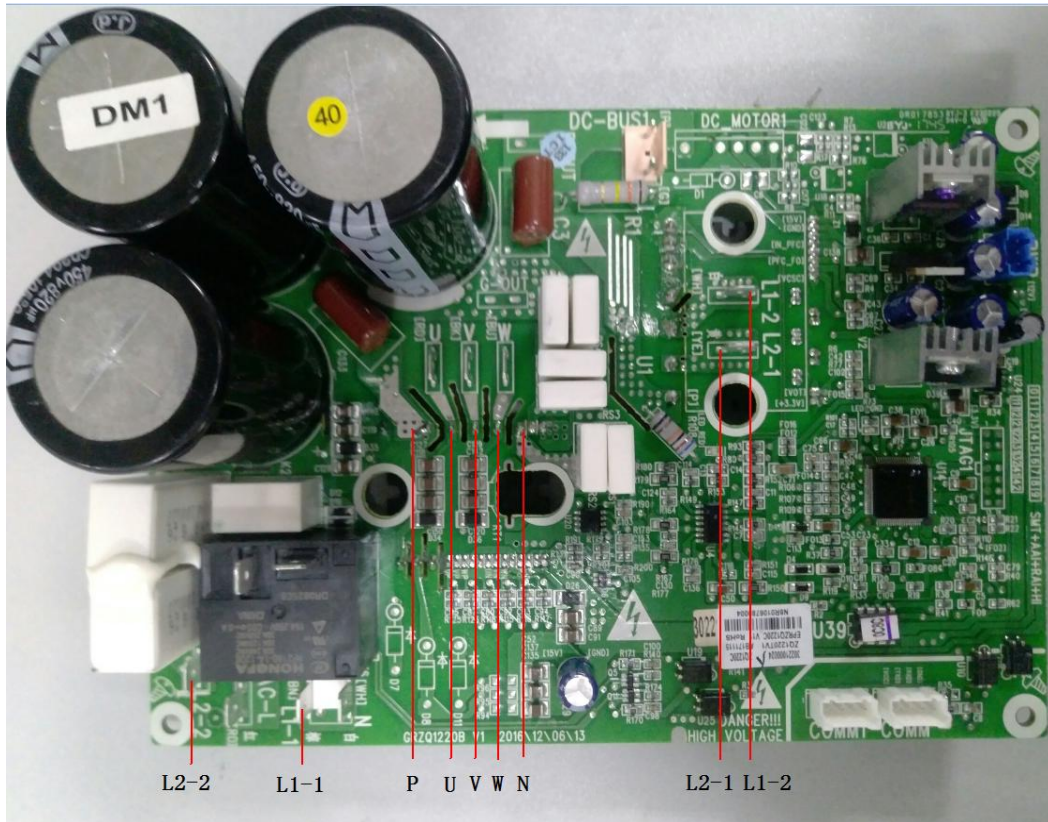

FLEXX60HP230V1AO

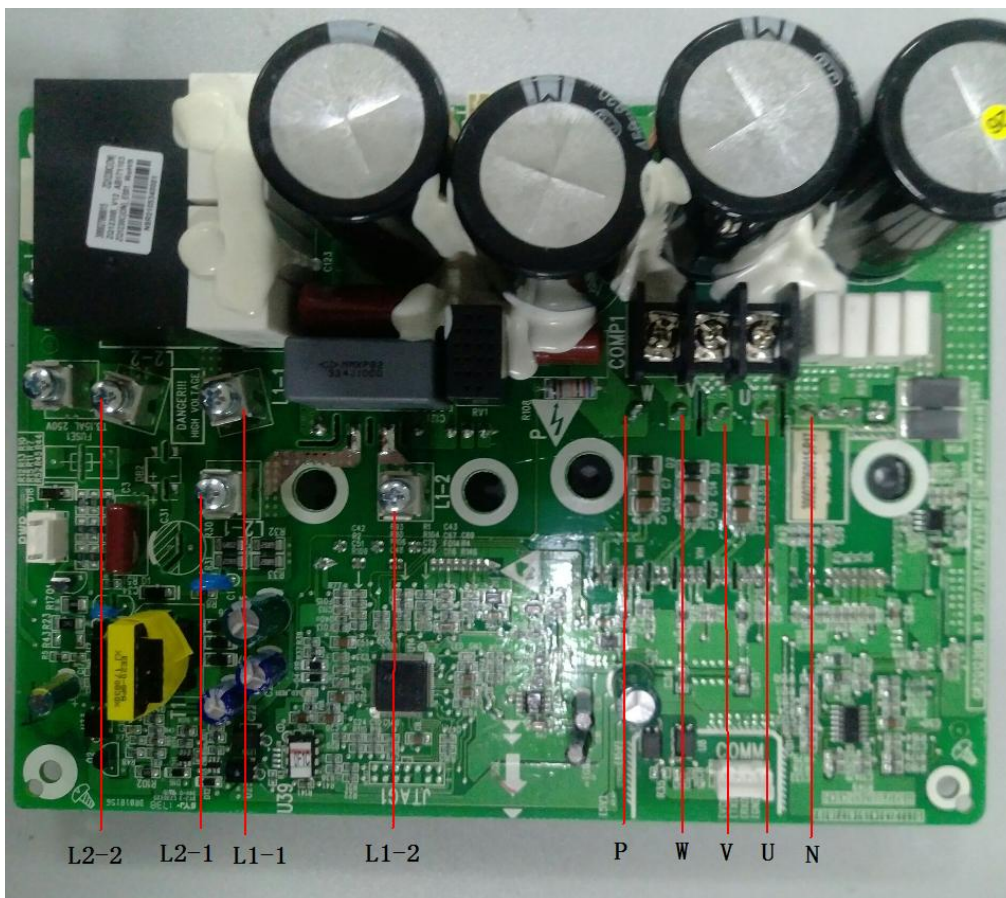

3.3 Error Code

No.	Error code	Error
1	E1	Compressor high pressure protection
2	E3	Compressor low pressure protection
3	E4	Compressor air discharge high-temperature protection
4	F2	Condenser temperature sensor error
5	F3	Outdoor ambient temperature sensor error
6	F4	Discharge temperature sensor error
7	F6	ODU tube temperature sensor error
8	EE	ODU memory chip error
9	H4	Overload
10	H5	IPM protection
11	H6	DC fan error
12	H7	Driver out-of-step protection
13	HC	Pfc protection
14	Lc	Startup failure
15	P0	Driver reset protection
16	P5	Over-current protection
17	P6	Master control and driver communication error
18	P7	Driver module sensor error
19	P8	Driver module high temperature protection
20	PA	AC current protection
21	Pc	Driver current error
22	PL	Bus low-voltage protection
23	PH	Bus high-voltage protection
24	PU	Charge loop error
25	ee	Drive memory chip error
26	e1	High pressure sensor error
27	C4	ODU jumper cap error

If malfunction occurs during operation, LCD temperature display zone will show the failure information. If several malfunctions occur at the same time, their corresponding error codes will be shown in turn. When malfunction occurs, please shut off the unit and send for professional personnel to repair. For example, E1 (as shown below) indicates high pressure protection.

3.4 Troubleshooting

3.4.1 “E1” Compressor High Pressure Protection

Error display: ODU mainboard LED displayer

Error judgment condition and method:

It is judged through the action of high pressure switch. If the high pressure switch is cut off, it is judged that high pressure is too high and the system stops operation for protection.

Possible reason:

- Cut-off valve of ODU is not fully opened;
- High pressure switch is abnormal;
- Outdoor or indoor fan is not working properly;
- IDU filter or air duct is blocked (heating mode);
- Ambient temperature is too high;
- Refrigerant charging amount is too much;
- System pipeline is blocked

Troubleshooting:

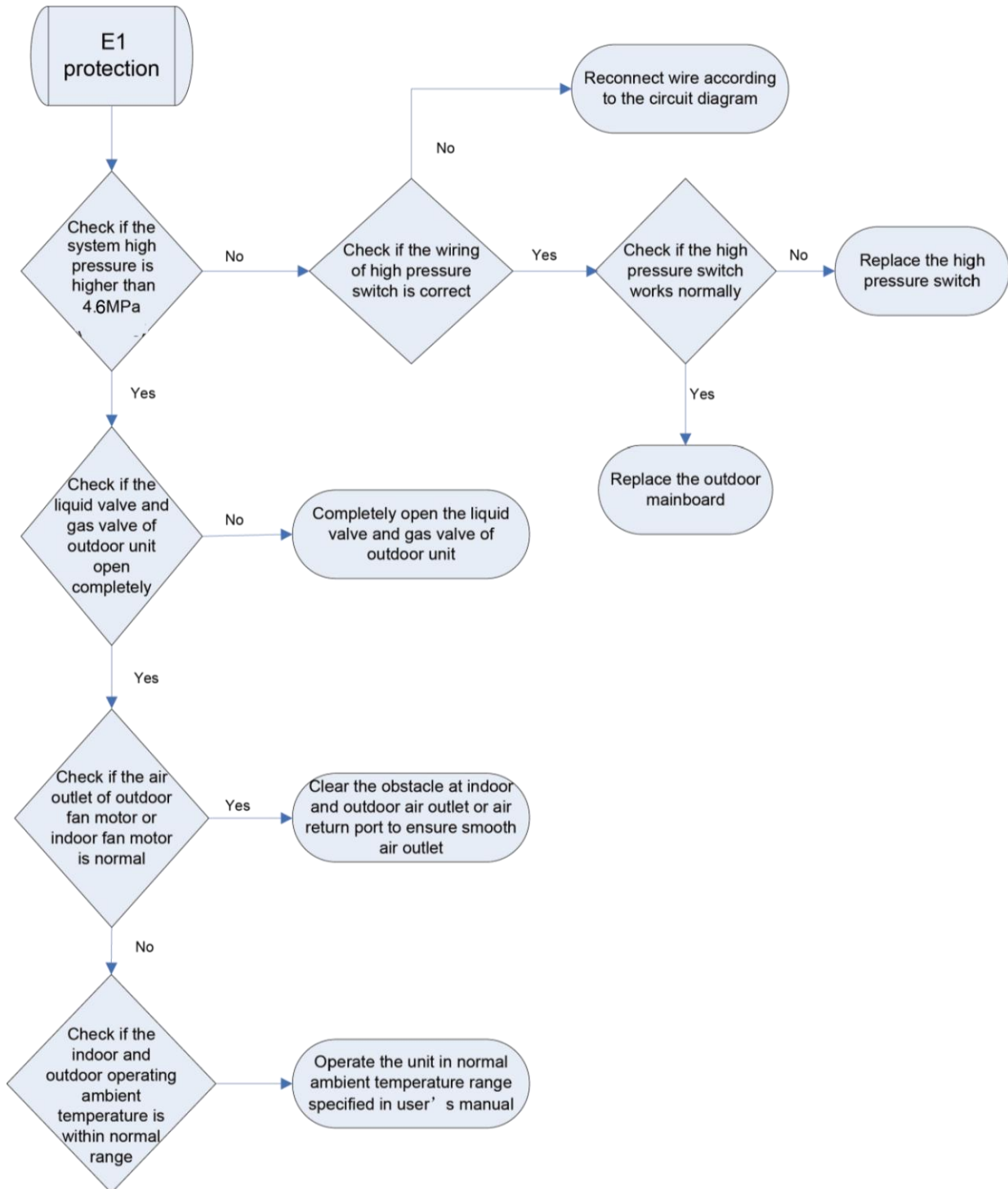

3.4.2 “E3” Compressor Low-pressure Protection, Refrigerant Shortage

Protection, Refrigerant Recovery Mode

Error display: ODU mainboard LED displayer

Error judgment condition and method:

It is judged through the action of low pressure switch. If the low pressure switch is cut off, it is judged that low pressure is too low and the system stops operation for protection.

Possible reason:

- Cut-off valve of ODU is not fully opened;
- Low pressure sensor is abnormal;
- Outdoor or indoor fan is not working properly;
- IDU filter or air duct is blocked (cooling mode);
- Ambient temperature is too low;
- Refrigerant charging amount is insufficient;
- System pipeline is blocked;

Troubleshooting:

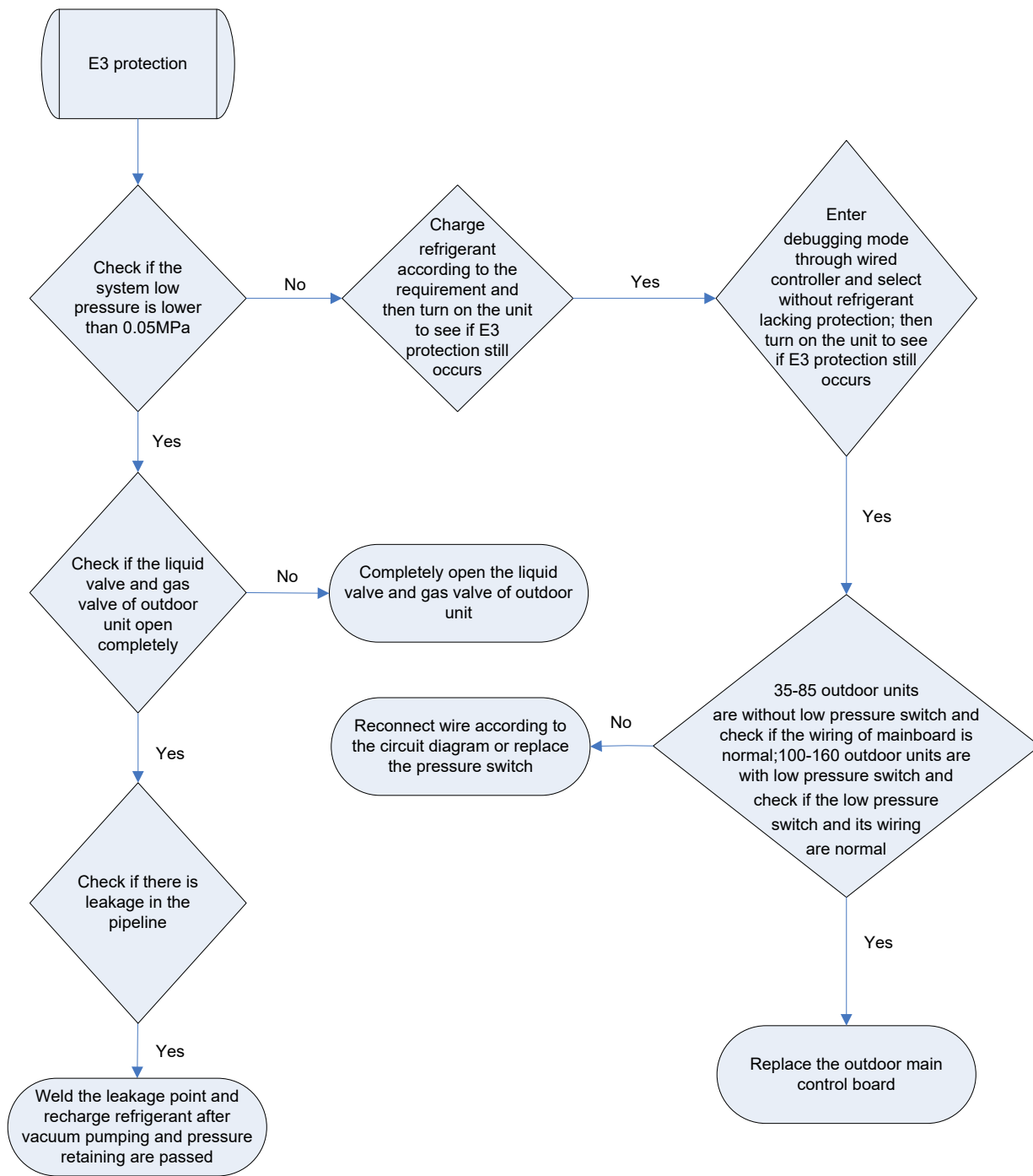

3.4.3 “E4” Compressor Air Discharge High-temperature Protection

Error display: ODU mainboard LED displayer

Error judgment condition and method:

Test the compressor discharge temperature through compressor discharge pipe and shell top temperature sensor. If the tested temperature value is higher than 115°C, the unit will stop for protection

Possible reason:

- Cut-off valve of ODU is not fully opened;
- Electronic expansion valve is abnormal;
- Outdoor or indoor fan is not working properly;
- IDU filter or air duct is blocked (cooling mode);
- Ambient temperature exceeds allowable operation range;
- Refrigerant charging amount is insufficient;
- System pipeline is blocked;

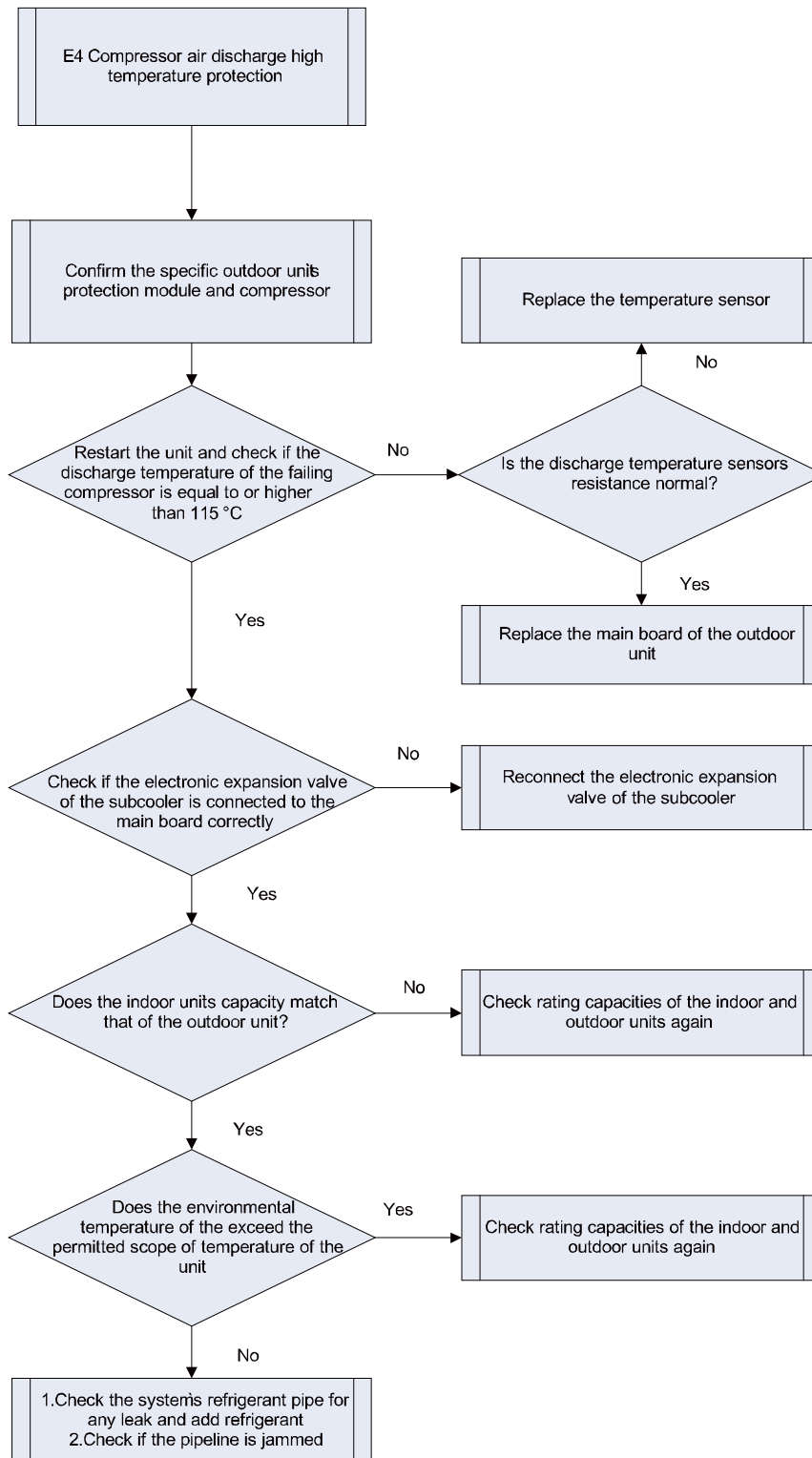
Troubleshooting:**3.4.4 “F2” Condenser Temperature Sensor Error**

Error display: ODU mainboard LED displayer

Error judgment condition and method:

Sample the AD value of temperature sensor through temperature sensor detecting circuit and judge the range of AD value, If the sampling AD value exceeds upper limit and lower limit in 5 seconds continuously, report

the error.

Possible reason:

- Poor contact between temperature sensor and terminal in mainboard interface
- Temperature sensor is abnormal
- Detecting circuit is abnormal

Troubleshooting:

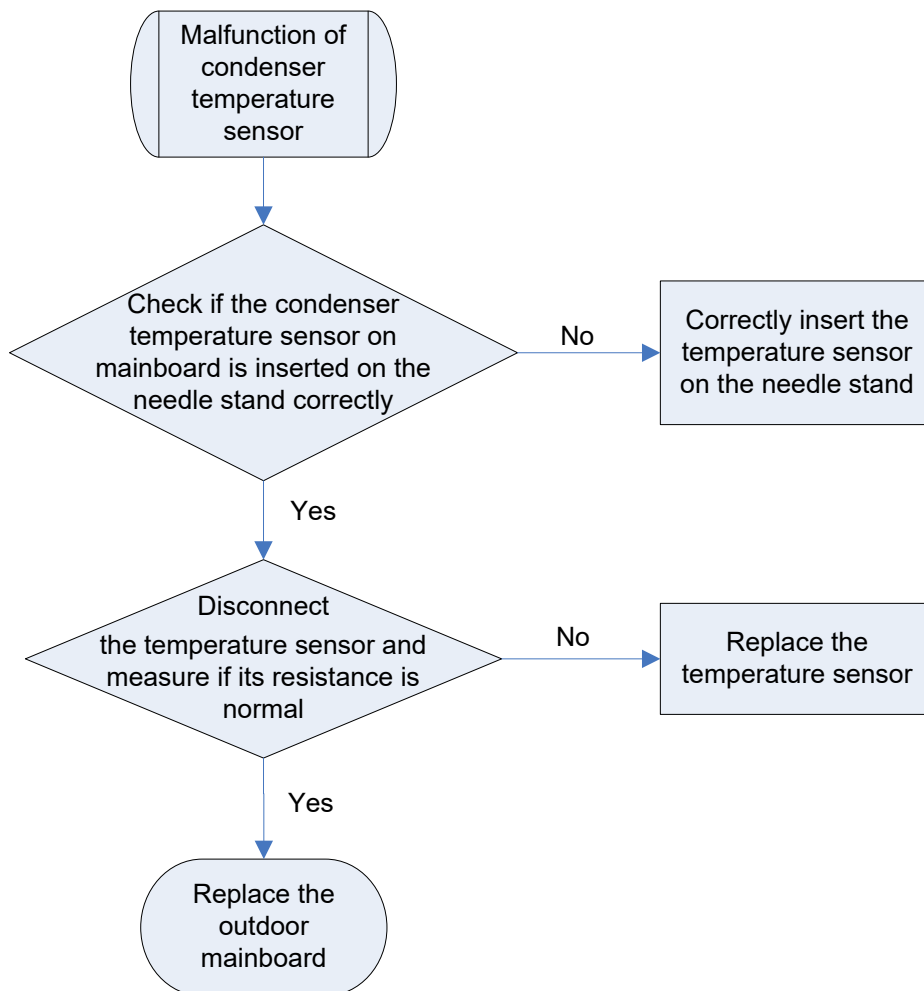

NOTE:

Please refer to Appendix 1 for the relation between temperature and resistance of temperature sensor.

3.4.5 “F3” Outdoor Ambient Temperature Sensor Error

Error display: ODU mainboard LED displayer

Error judgment condition and method:

Sample the AD value of temperature sensor through temperature sensor detecting circuit and judge the range of AD value, If the sampling AD value exceeds upper limit and lower limit in 5 seconds continuously, report the error.

Possible reason:

- Poor contact between ambient temperature sensor and terminal in mainboard interface
- Ambient temperature sensor is abnormal
- Detecting circuit is abnormal

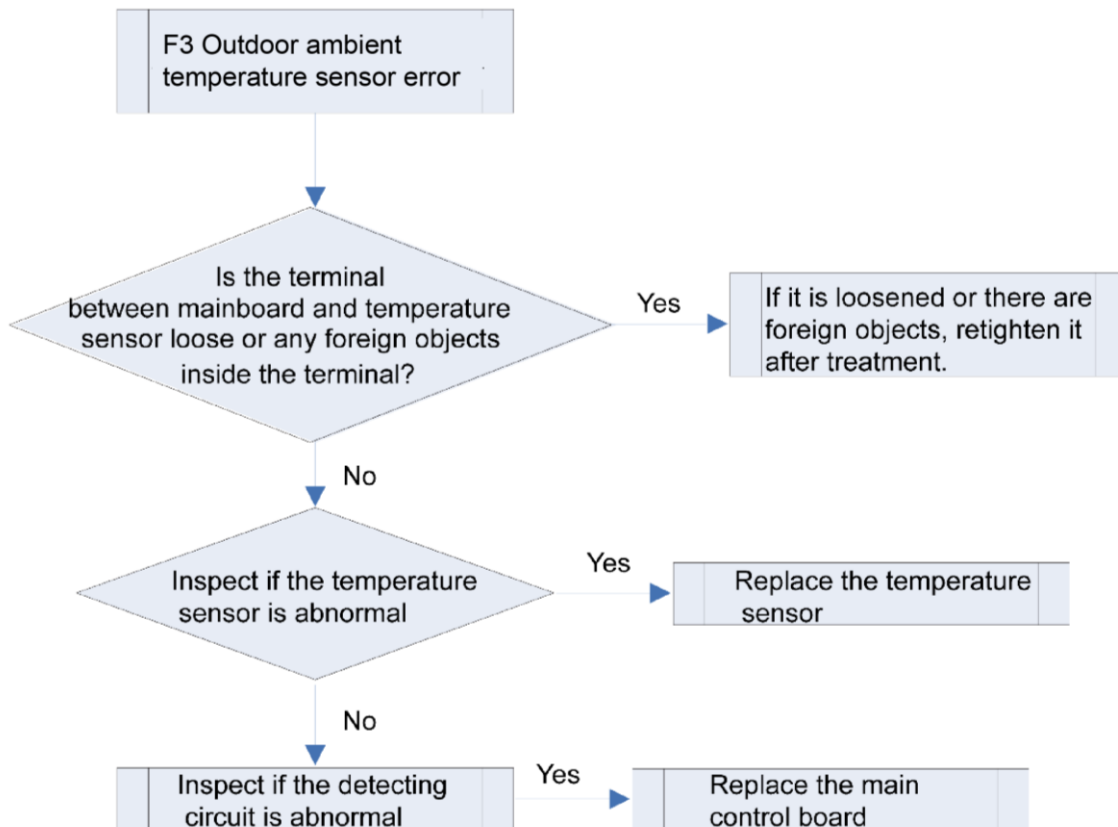
Troubleshooting:**NOTE:**

Please refer to Appendix 1 for the relation between temperature and resistance of temperature sensor.

3.4.6 “F4” Discharge Temperature Sensor Error

Error display: ODU mainboard LED displayer

Error judgment condition and method:

Sample the AD value of temperature sensor through temperature sensor detecting circuit and judge the range of AD value, If the sampling AD value exceeds upper limit and lower limit in 5 seconds continuously, report the error.

Possible reason:

- Poor contact between temperature sensor and terminal in mainboard interface
- Temperature sensor is abnormal
- Detecting circuit is abnormal

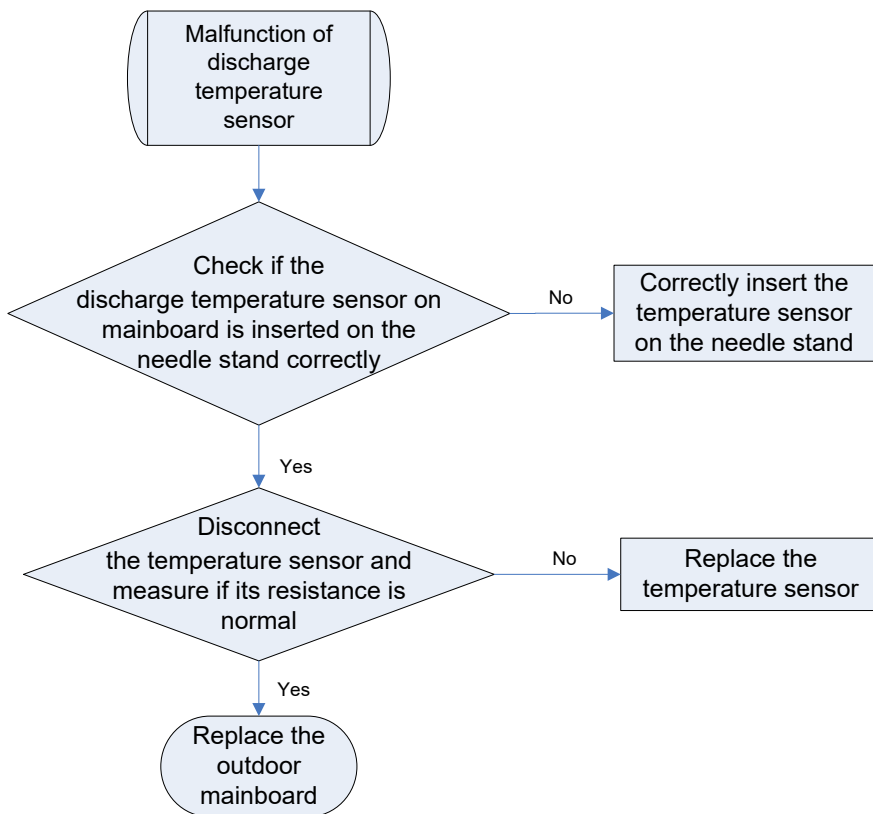
Troubleshooting:**NOTE:**

Please refer to Appendix 1 for the relation between temperature and resistance of temperature sensor.

3.4.7 “F6” ODU Tube Temperature Sensor Error

Error display: ODU mainboard LED displayer

Error judgment condition and method:

Sample the AD value of temperature sensor through temperature sensor detecting circuit and judge the range of AD value, If the sampling AD value exceeds upper limit and lower limit in 5 seconds continuously, report the error.

Possible reason:

- Poor contact between temperature sensor and terminal in mainboard interface
- Temperature sensor is abnormal
- Detecting circuit is abnormal

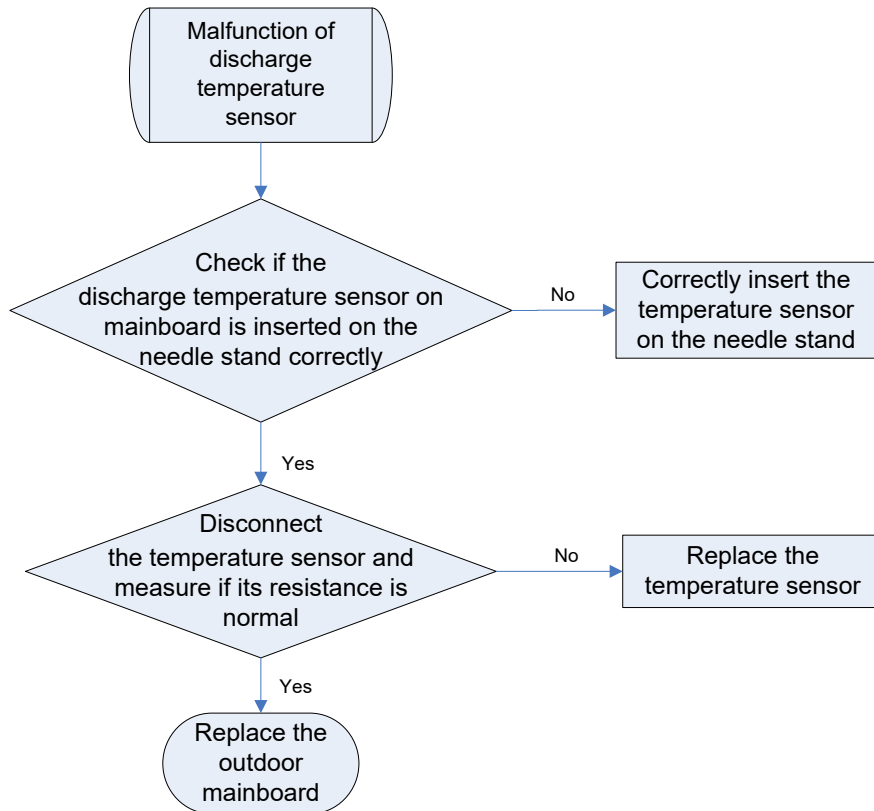
Troubleshooting:**NOTE:**

Please refer to Appendix 1 for the relation between temperature and resistance of temperature sensor.

3.4.8“EE” ODU Memory Chip Error

Error display: ODU mainboard LED displayer

Error judgment condition and method:

If ODU mainboard cannot read the memory chip, this error will be reported.

Possible reason:

- Memory chip on the ODU mainboard is damaged.
- Memory chip is weakly welded.
- Memory chip lead is short-circuited.

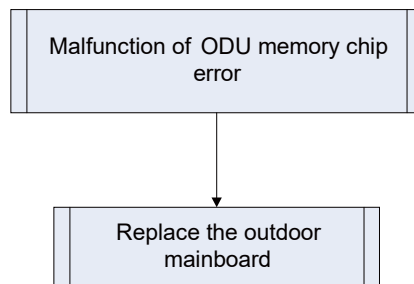
Troubleshooting:

3.4.9 “H4” Overload

Error display: ODU mainboard LED displayer

Error judgment condition and method:

When condensing pressure is higher than the protection value, system will report overload protection.

Possible reason:

- Cooling ODU heat exchanger is blocked or heat exchange is bad.
- Heating IDU heat exchanger is blocked or heat exchange is bad.
- Operating temperature is too high.
- System charging quantity is too much.

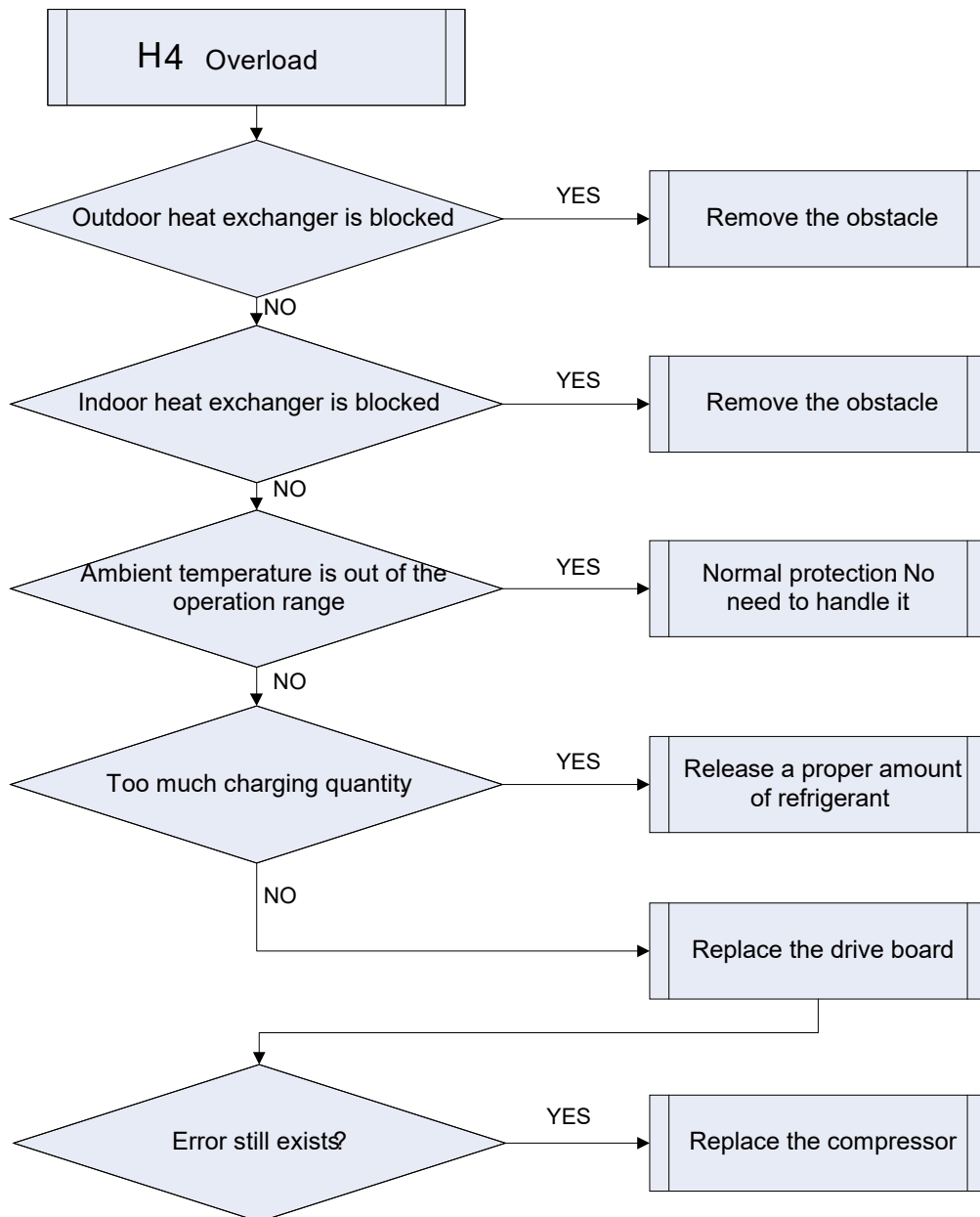
Troubleshooting:**3.4.10 “H5” IPM Protection**

Error display: ODU mainboard LED displayer

Error judgment condition and method:

When power is connected and drive chip received IPM lead F0 that is of low level, than it is IPM module malfunction. System will shut down for protection.

Possible reason:

- Compressor 3-phase wire connection is lack of phase or phase-reversed.
- System is overloaded and compressor current is too large.
- Drive board IPM module is damaged.

- Drive board IPM module's 15V power supply is lower than 13.5V.
- Drive board 6-line PWM signal and the corresponding element are abnormal.
- Drive board compressor current sampling circuit element is damaged or drive chip current sampling AD terminal is abnormal.
- Compressor is damaged.

Troubleshooting:

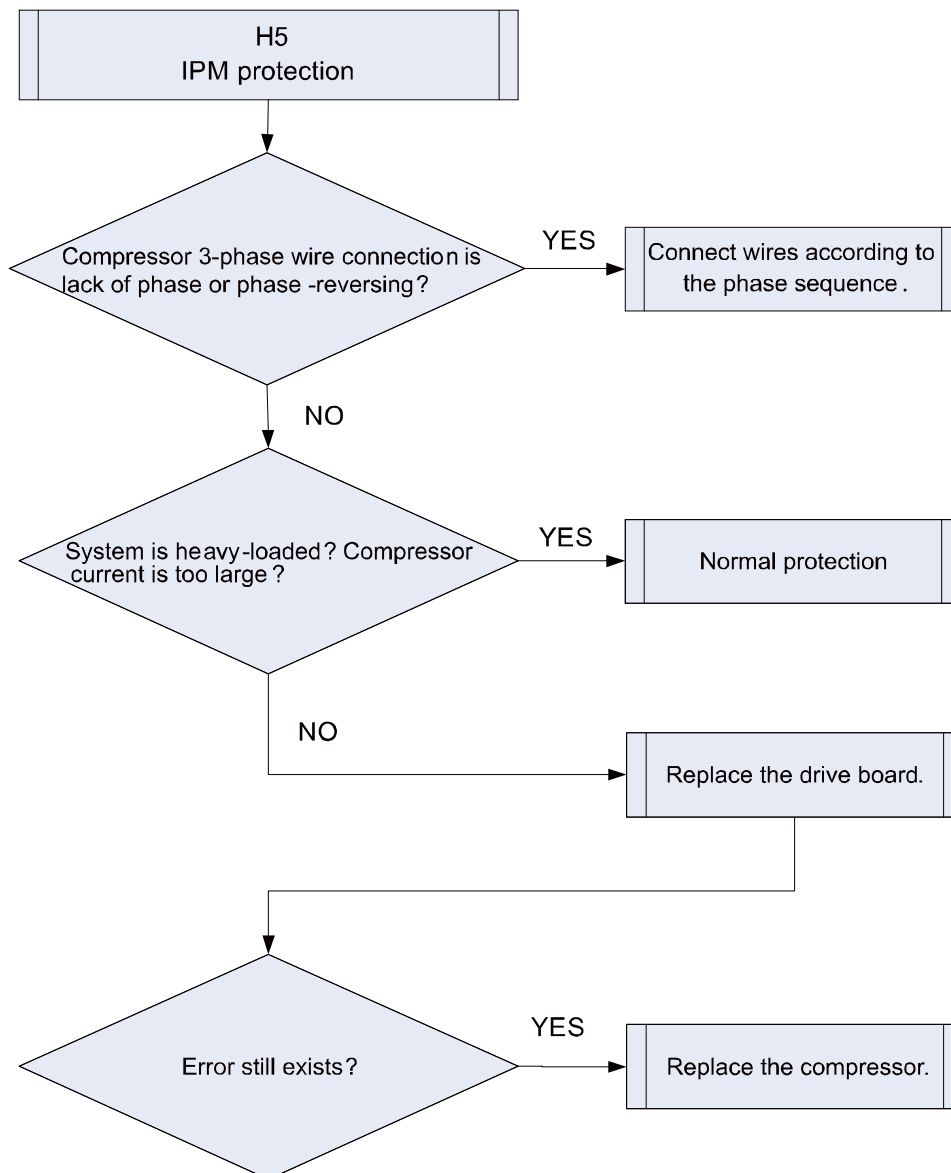

3.4.11 "H6" DC Fan Error

Error display: ODU mainboard LED displayer

Error judgment condition and method:

Mainboard doesn't receive the signal of outdoor fan within 30s after the outdoor fan starts up.

Possible reason:

- Outdoor fan wiring terminal is not correctly connected to the mainboard.
- Outdoor fan is damaged.
- If it is a new unit or a new motor has been replaced in the unit and the wire connection is correct, then probably it is the program that goes wrong.

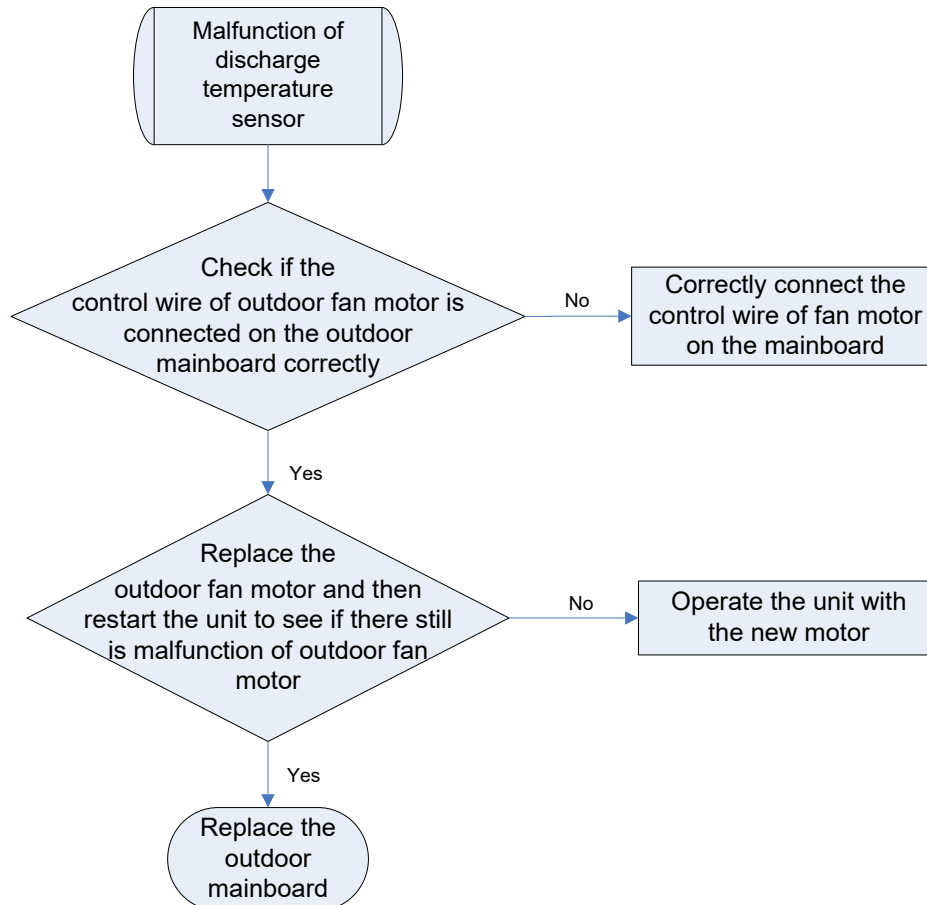
Troubleshooting:**3.4.12 “H7” Driver Out-of-Step Protection**

Error display: ODU mainboard LED displayer

Error judgment condition and method:

During operation, it can't detect the rotor position and stops output. Or the actual running speed differs too much from the set running speed. In each case, compressor runs out of step and system stops for protection.

Possible reason:

- Compressor 3-phase wire connection is lack of phase or phased-reversed.
- Compressor phase wire connection is bad.
- System is blocked, short of refrigerant or compressor oil.
- Drive board IPM module is damaged.

■ Drive board compressor current sampling circuit element is damaged or drive chip current sampling AD terminal is abnormal.

■ Compressor is damaged.

Troubleshooting:

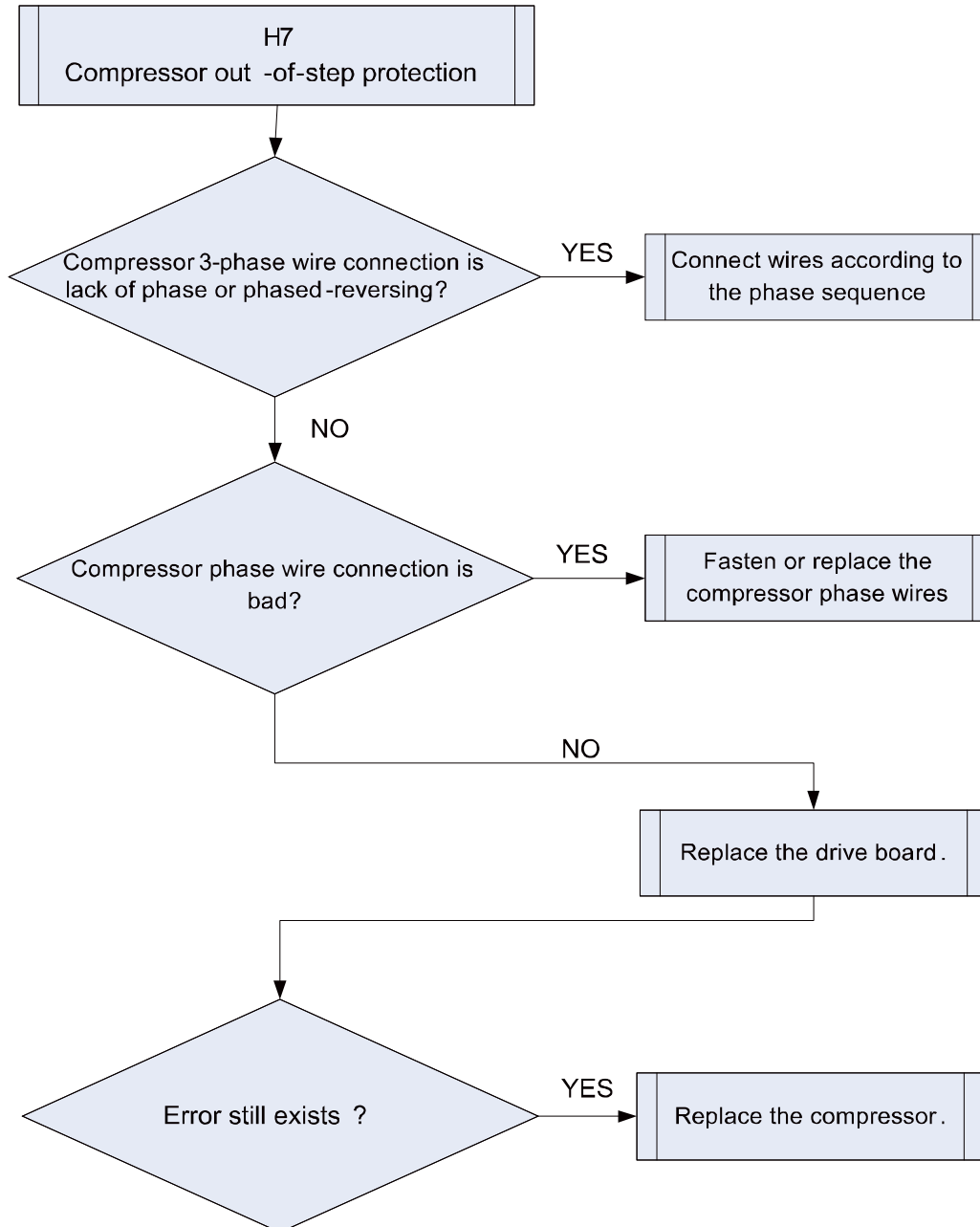

3.4.13 “HC” PFC Protection

Error display: ODU mainboard LED displayer

Error judgment condition and method:

After power is connected, and drive chip received PFC lead F0 that is of low level, then it is PFC module malfunction. System will shut down for protection.

Possible reason:

- Power grid voltage is abnormal.
- Drive board PFC module is damaged.
- Drive board PFC module's 15V power supply is lower than 13.5V.
- Drive board PWM signal for PFC and the corresponding element are abnormal.
- Drive board PFC current sampling circuit element is damaged or drive chip current sampling AD terminal is abnormal.

Troubleshooting:

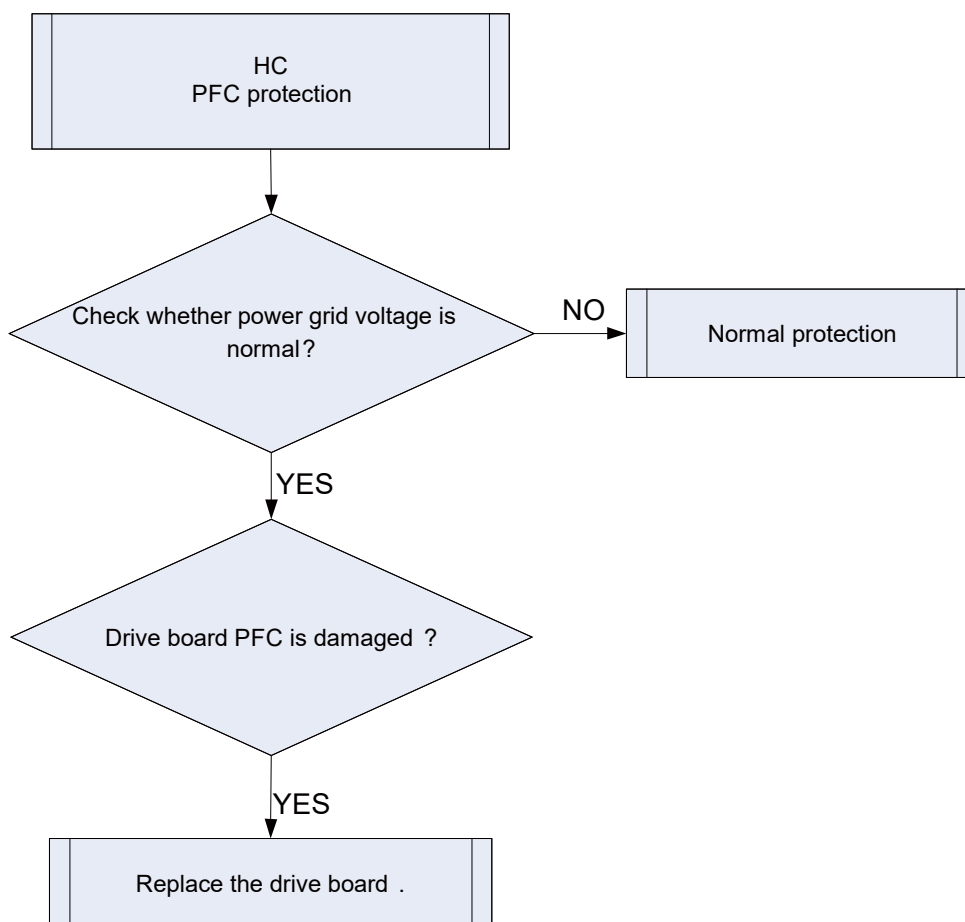

3.4.14 “Lc” Startup Failure

Error display: ODU mainboard LED displayer

Error judgment condition and method:

Check the error code on nixie tube of ODU main control board. If PJ is displayed, it indicates inverter compressor startup failure

Possible reason:

- Poor contact of compressor UVW wire;
- Compressor is broken;
- Compressor drive board is broken;

Troubleshooting:

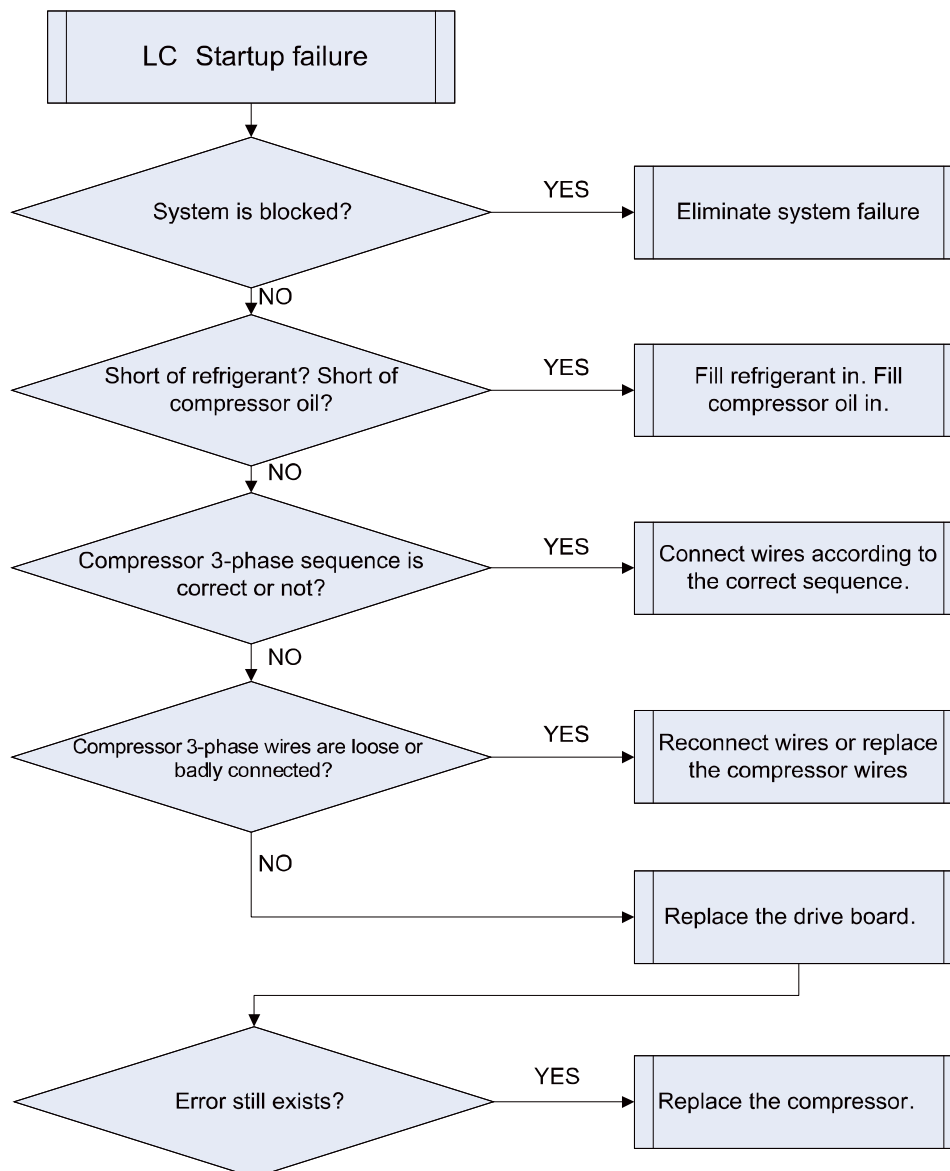

3.4.15 “P0” Driver Reset Protection

Error display: ODU mainboard LED displayer

Error judgment condition and method:

Drive board chip resets and starts initialization. After the drive board is energized for 5s, it detects that the chip resets again. In this case, it can be judged as drive chip reset protection.

Possible reason:

- 3.3V drive chip supply voltage drop.
- TRST lead of JTAG programming is interrupted.

Troubleshooting:

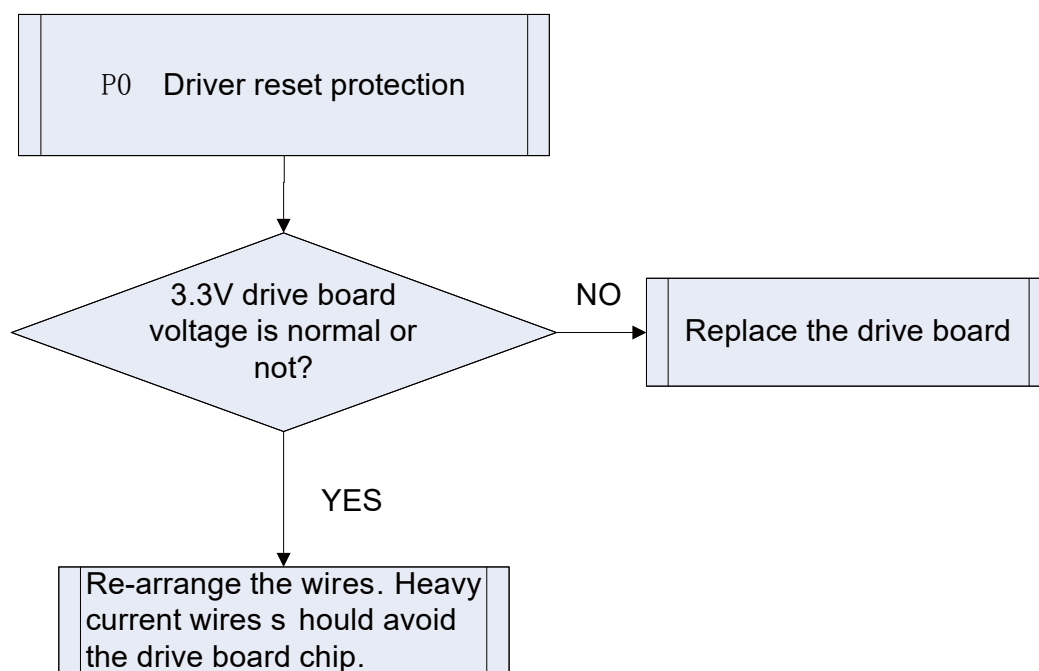

3.4.16 “P5” Over-Current Protection

Error display: ODU mainboard LED displayer

Error judgment condition and method:

If compressor’s instant current value is higher than the set current protection value, then it can be judged that compressor over-current occurs and system will shut down for protection.

Possible reason:

- System load is too much and compressor current is too large.
- Compressor 3-phase wire connection is lack of phase or phase-reversed.
- Compressor phase wire is loose or has bad contact.

■ Drive board current sampling circuit element is damaged or drive chip current sampling AD terminal is abnormal.

■ Compressor is damaged.

Troubleshooting:

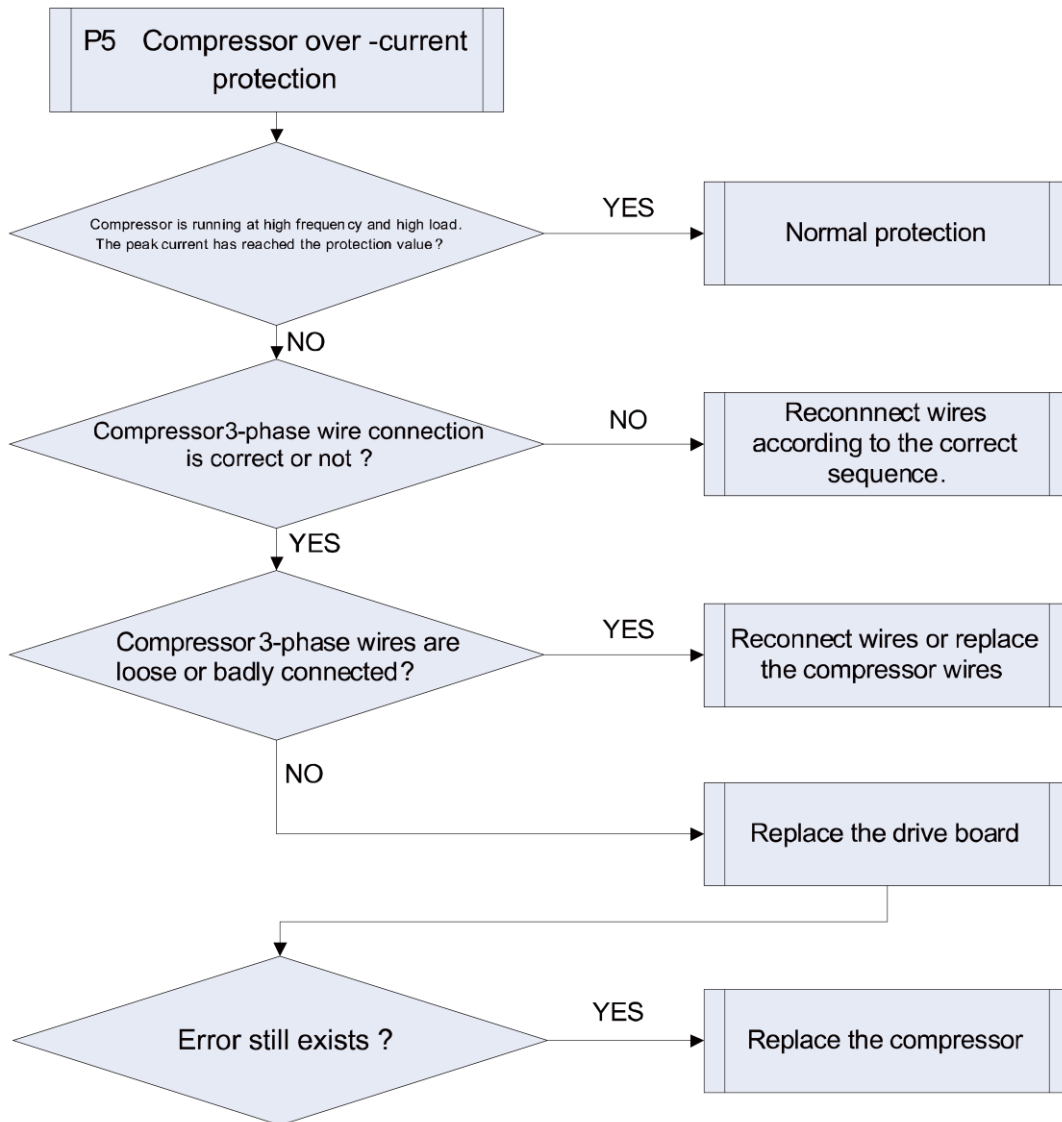

3.4.17 “P6” Master Control and Driver Communication Error

Error display: ODU mainboard LED displayer

Error judgment condition and method:

If there is no other malfunction and the communication between master control and driver is cut off for 30s, then it can be judged that the communication between master control and driver is faulted. System will shut down for protection.

Possible reason:

■ Communication wire between master control and driver is not well connected, or has bad contact, or is broken.

- The switch power of drive board is abnormal, therefore, the 3.3V power voltage is abnormal.
- Communication circuit of the drive board or the master control board is abnormal.

Troubleshooting:

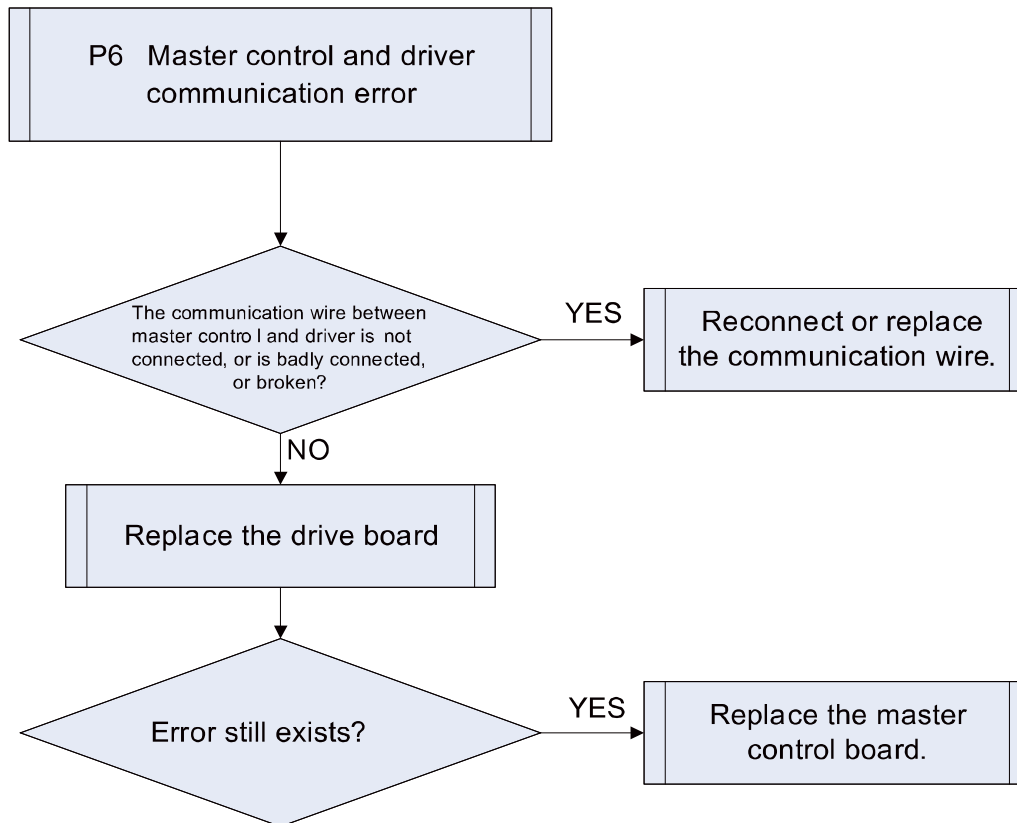

3.4.18 “P7” Driver Module Sensor Error

Error display: ODU mainboard LED displayer

Error judgment condition and method:

If IPM or PFC module temperature is lower than the set protection value, then it can be judged that driver module sensor error occurs and system will shut down for protection.

Possible reason:

- Module temperature sensor is short-circuited or broken-circuited.
- Drive board current sampling circuit element is damaged or drive chip current sampling AD terminal is abnormal.

Troubleshooting:

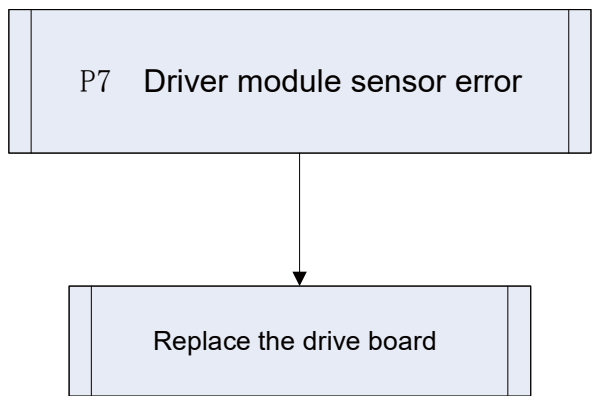

3.4.19 “P8” Driver Module High Temperature Protection

Error display: ODU mainboard LED displayer

Error judgment condition and method:

If IPM module temperature or PFC module temperature exceeds the set protection value, then it can be judged that driver module temperature is too high and system will shut down for protection.

Possible reason:

- Thermal grease is not applied or not evenly applied to the module, or there is other substance on the back of the module.
- The module securing screws are not tightened up.
- Drive board temperature sampling circuit element is damaged or drive chip temperature sampling AD terminal is abnormal.

Troubleshooting:

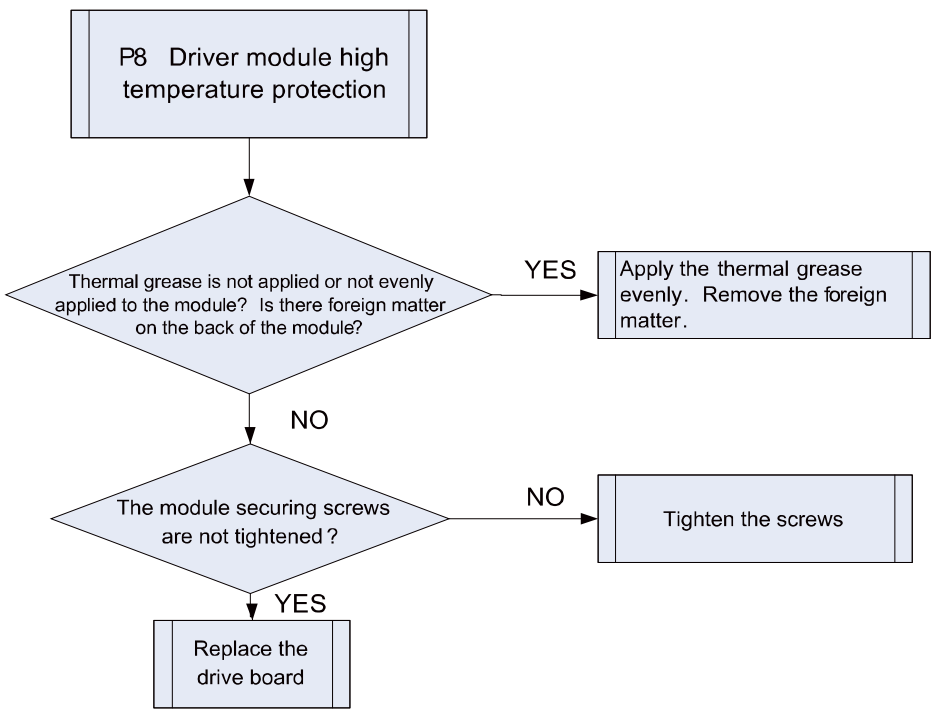

3.4.20 “PA” AC Current Protection

Error display: ODU mainboard LED displayer

Error judgment condition and method:

If input current value exceeds the set protection value, then it can be judged that AC current protection occurs and system will shut down for protection.

Possible reason:

- System is heavy-loaded and compressor current is too large.
- Grid voltage is abnormal.
- PFC module is damaged.
- Drive board PFC current sampling circuit element is damaged or drive chip PFC current sampling AD terminal is abnormal.

Troubleshooting:

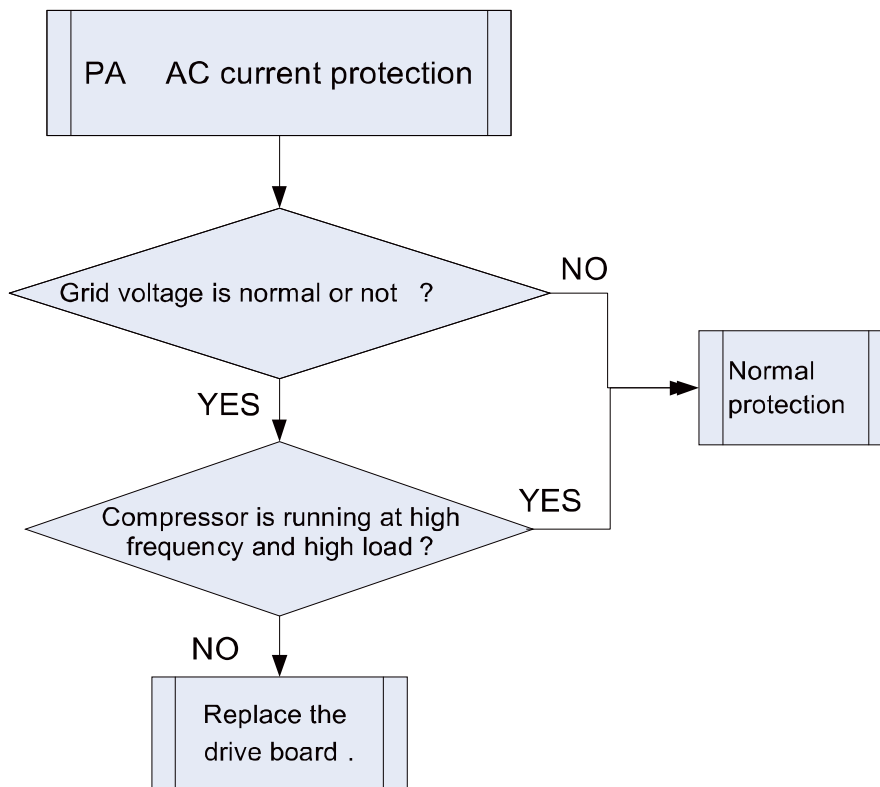

3.4.21 “Pc” Driver Current Error

Error display: ODU mainboard LED displayer

Error judgment condition and method:

After power charging, if offset voltage average is detected to exceed 12.5% of 1.65V in 1s, then it can be judged that current detection (or current sensor) circuit is faulted. System will shut down for protection.

Possible reason:

- Current detection (or current sensor) sampling circuit element is abnormal.
- Drive chip compressor current sampling AD terminal is badly welded or short-circuited.

Troubleshooting:

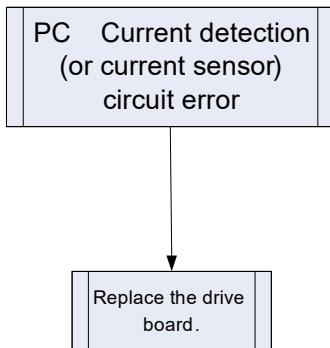

3.4.22 “PL” Bus Low-Voltage Protection

Error display: ODU mainboard LED displayer

Error judgment condition and method:

When compressor is running and there is no other malfunction, if busbar voltage is lower than the set value for low voltage protection, then it can be judged that bus low-voltage protection occurs. System will shut down for protection.

Possible reason:

- Voltage of power grid is abnormal.
- Drive board busbar voltage sampling circuit element is damaged or drive board busbar voltage sampling AD terminal is abnormal.

Troubleshooting:

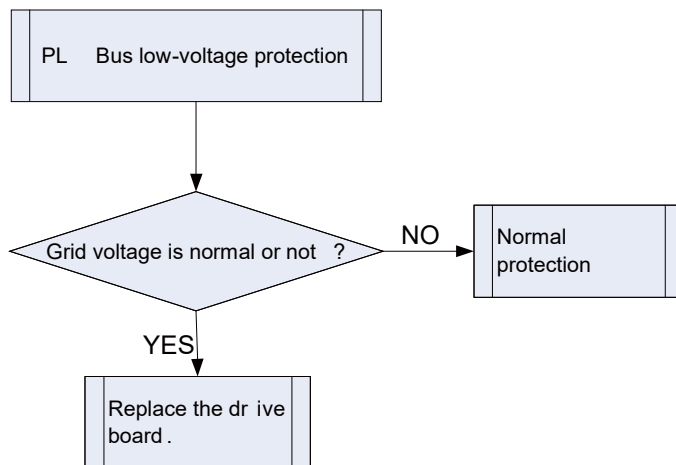

3.4.23 “PH” Bus High-Voltage Protection

Error display: ODU mainboard LED displayer

Error judgment condition and method:

If there is no other malfunction and the busbar voltage is higher than the set value for high voltage protection, then it can be judged that bus high-voltage protection occurs. System will shut down for protection.

Possible reason:

- Voltage of power grid is abnormal.
- Drive board busbar voltage sampling circuit element is damaged or drive board busbar voltage sampling AD terminal is abnormal.

Troubleshooting:

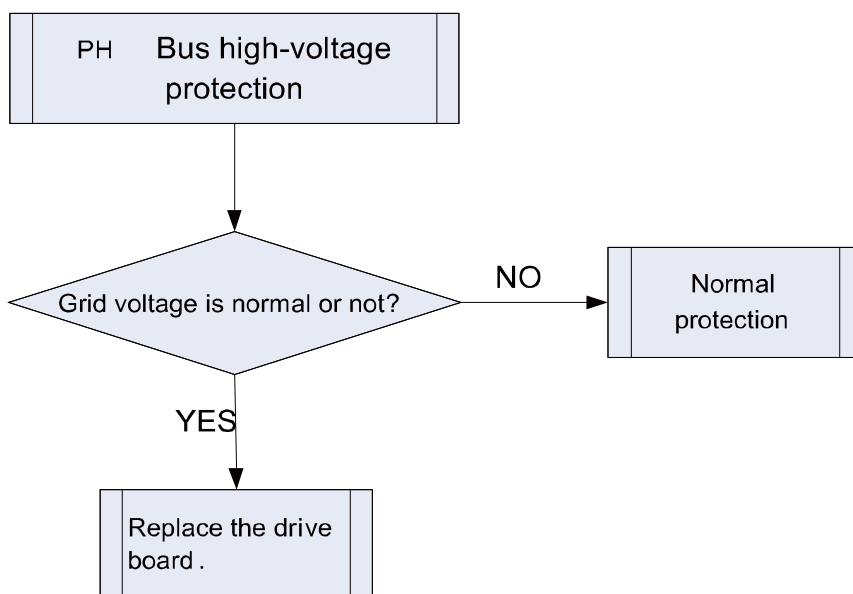

3.4.24 “PU” Charge Loop Error

Error display: ODU mainboard LED displayer

Error judgment condition and method:

When the charge loop starts to get charged and the busbar voltage cannot reach the set value in a certain period of time, then it can be judged that charge loop error exists. System will shut down for protection.

Possible reason:

- Voltage of power grid is abnormal. Voltage is too low.
- Drive board charge loop element is abnormal.
- Drive board busbar voltage sampling circuit element is damaged or drive chip busbar voltage sampling AD terminal is abnormal.

Troubleshooting:

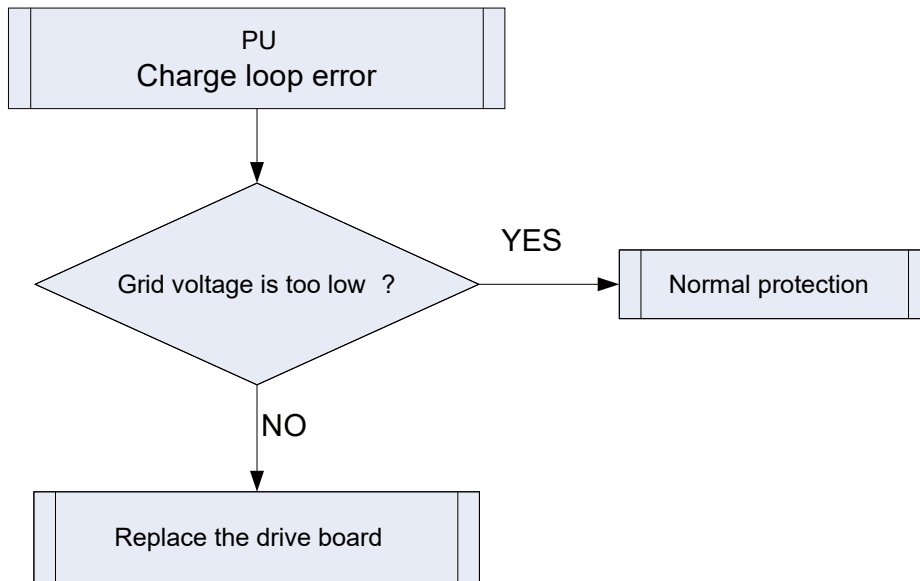

3.4.25 “ee” Drive Memory Chip Error

Error display: ODU mainboard LED displayer

Error judgment condition and method:

If power is connected but the drive board with memory chip cannot detect the memory chip or read the memory chip data correctly, then it can be judged that drive memory chip error exists.

Possible reason:

- The drive board that needs memory chip is not installed with the memory chip.
- The lead or connector of memory chip is badly welded or short-circuited.

Troubleshooting:

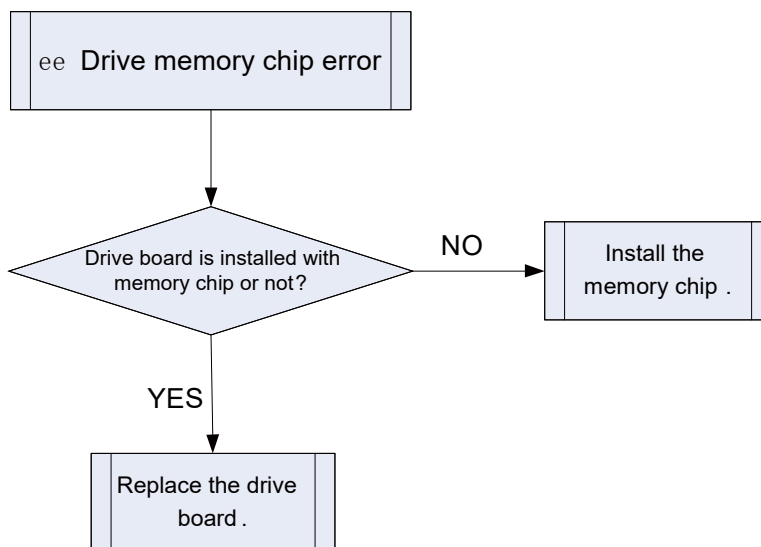

3.4.26 “e1” High Pressure Sensor Error

Error display: ODU mainboard LED displayer

Sample the AD value of pressure sensor through pressure sensor detecting circuit and judge the range of AD value, If the sampling AD value exceeds upper limit and lower limit in 30 seconds continuously, report the error.

- Poor contact between pressure sensor and terminal in mainboard interface
- Pressure sensor is abnormal
- Detecting circuit is abnormal

Troubleshooting:

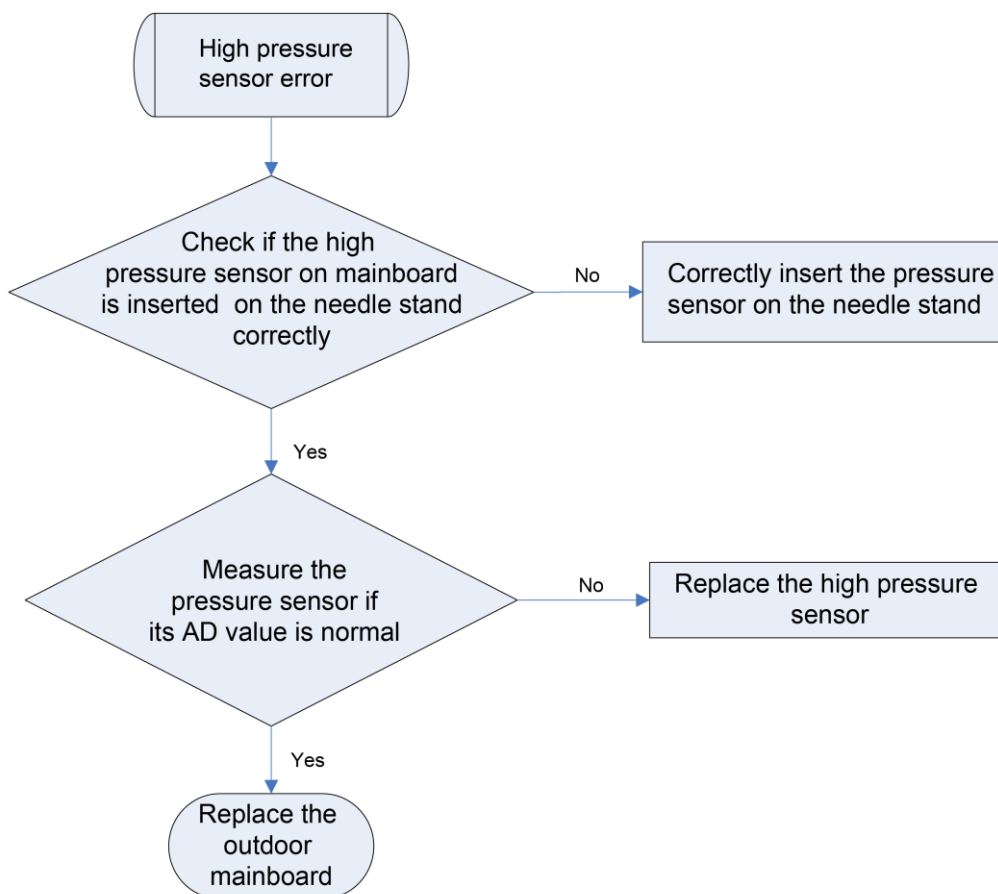

3.4.27 “C4” ODU Jumper Cap Error

Error display: ODU mainboard LED displayer

Error judgment condition and method:

If jumper cap model doesn't match with mainboard, report the error

Possible reason:

- Jumper cap is not installed
- Jumper cap model is wrong
- Detecting circuit is abnormal

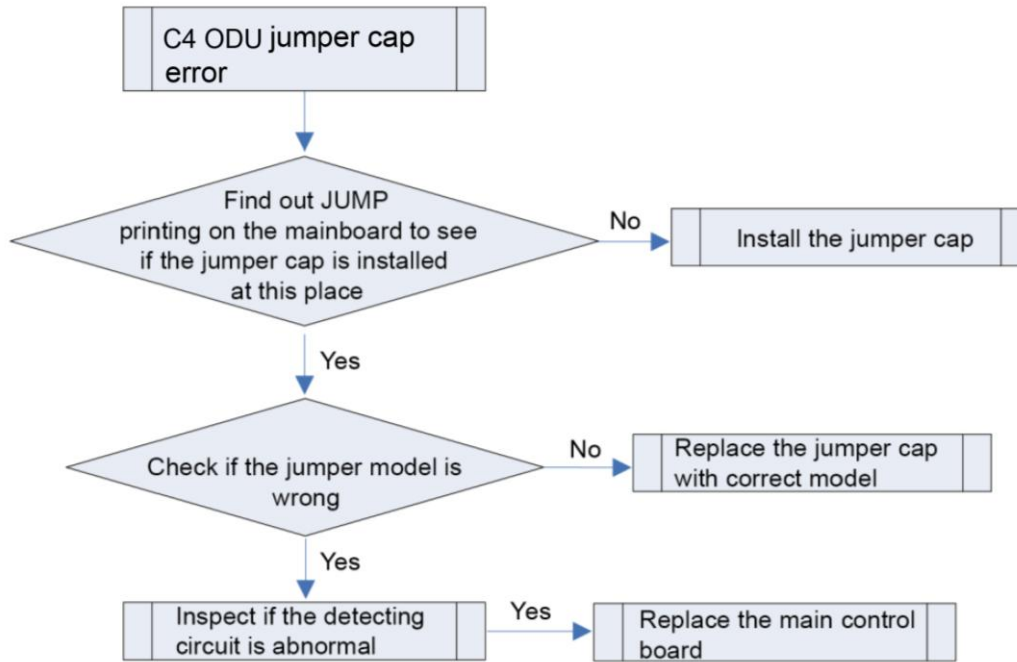
Troubleshooting:

3.5 Failures Not Caused by Errors

(1) If your air conditioner fails to function normally, please first check the following items before maintenance:

Problem	Cause	Corrective measure
The air conditioner can't run.	If you turn off the unit and then immediately turn it on, in order to protect the compressor and avoid system overload, compressor will delay running for 3min.	Please wait for a while.
	Wire connection is wrong.	Connect wires according to the wiring diagram.
	Fuse or circuit breaker is broken.	Replace the fuse or switch on the circuit breaker.
	Power failure.	Restart after power is resumed.
	Power plug is loose.	Re-insert the power plug.
	Thermostat has low battery.	Replace the batteries.
Bad cooling or heating effect.	Air inlet and outlet of the units have been blocked.	Clear the obstacles and keep the room for the units well ventilated.
	Improper temperature setting	Reset a proper temperature.
	Fan speed is too low.	Reset a proper fan speed.
	Air flow direction is not right.	Change the direction of air louvers.
	Doors or windows are open.	Close them.
	Exposed under direct sunshine.	Put on curtains or louvers in front of the windows.
	Too many heat sources in the room.	Remove unnecessary heat sources.
	Filter is blocked or dirty.	Send for a professional to clean the filter.
Air inlets or outlets of the units are blocked.	Clear away obstacles that are blocking the air inlets and outlets of the units.	

(2) The following situations are not operation failures.

Problem	Time of occurrence	Cause
Mist comes from the air conditioner.	During operation.	If the unit is running under high humidity, the wet air in the room will be quickly cooled down.
The air conditioner generates some noise.	System switches to heating mode after defrosting.	Defrosting process will generate some water, which will turn to water vapor.
	The air conditioner is buzzing at the beginning of operation.	Thermostat will be buzzing when it starts working. The noise will become weak 1min later.
Dust comes from the air conditioner.	When the unit is turned on, it purrs.	When the system is just started, the refrigerant is not stable. About 30s later, the purr of the unit becomes low.
	About 20s after the unit first enables the heating mode or there is refrigerant brushing sound when defrosting under heating.	It's the sound of 4-way valve switching direction. The sound will disappear after the valve changes its direction.
	There is hissing sound when the unit is started or stopped and a slight hissing sound during and after operation.	It's the sound of gaseous refrigerant that stops flowing and the sound of drainage system.
	There is a sound of crunching during and after operation.	Because of temperature change, front panel and other components may be swelled up and cause abrasion sound.
	There is a hissing sound when the unit is turned on or suddenly stopped during operation or after defrosting.	Because refrigerant suddenly stops flowing or changes the flow direction.
	The unit starts operation after being unused for a long time.	Dust inside the units come out together with the air.
The air conditioner generates some smell.	During operation.	The room smell or the smell of cigarette comes out through the units.



NOTICE:

Check the above items and adopt the corresponding corrective measures. If the air conditioner continues to function poorly, please stop the air conditioner immediately and contact Gree's authorized local service center. Ask our professional service staff to check and repair the unit.

4 Maintenance

4.1 System Diagram

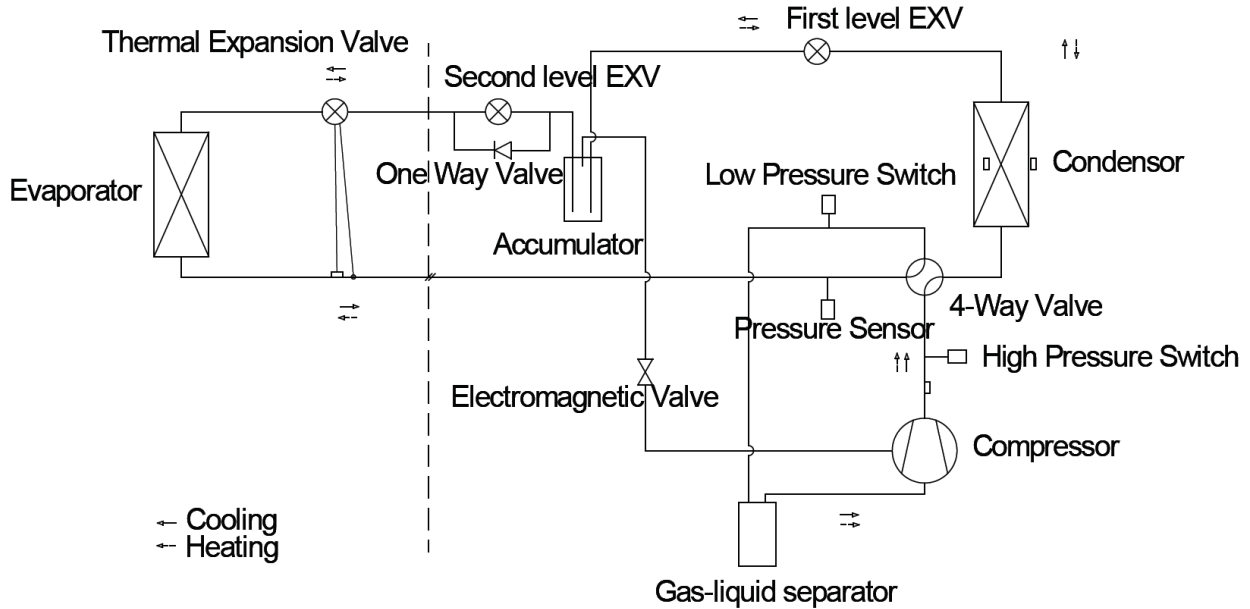

4.2 Connection Pipe Vacuum Pumping



NOTICE

- ① Make sure the outlet of vacuum pump is away from fire source and is well-ventilated.
- ② Before vacuum pumping, make sure the unit cut-off valves are closed.
- ③ When vacuum pumping, both the liquid pipe and the gas pipe must be pumped.

- (1) Remove the caps of the liquid valve, gas valve and also the service port.
- (2) meanwhile the gas and liquid valves should be kept closed in case of refrigerant leak.
- (3) Connect the hose used for evacuation to the vacuum pump.
- (4) Open the switch at the lower pressure side of the manifold valve assembly and start the vacuum pump. Meanwhile, the switch at the high pressure side of the manifold valve assembly should be kept closed, otherwise evacuation would fail.
- (5) The evacuation duration depends on the unit's capacity, generally.

Model	Time(min)
FLEXX36HP230V1AO	35
FLEXX60HP230V1AO	40

And verify if the pressure gauge at the low pressure side of the manifold valve assembly reads -0.1Mpa (-750mmHg), if not, it indicates there is leak somewhere. Then, close the switch fully and then stop the vacuum pump.

- (6) Wait for 10min to see if the system pressure can remain unchanged. If the pressure increase, there may be leakage.
- (7) Slightly open the liquid valve and let some refrigerant go to the connection pipe to balance the pressure inside and outside of the connection pipe, so that air will not come into the connection pipe when removing the hose. Notice that the gas and liquid valve can be opened fully only after the manifold valve assembly is removed.
- (8) Place back the caps of the liquid valve, gas valve and also the service port.

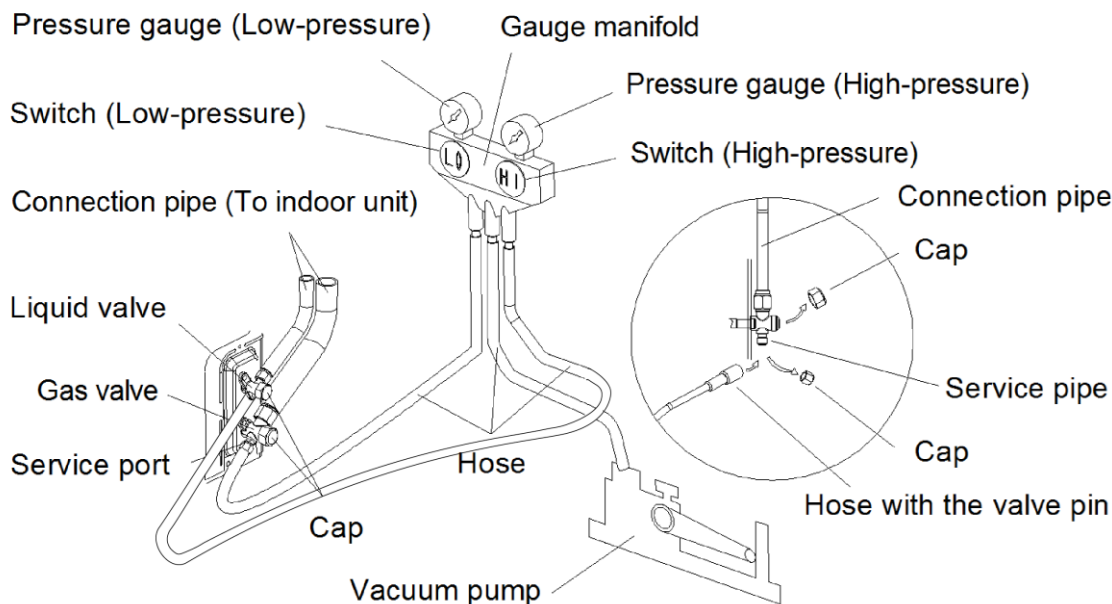

NOTICE:

For large-size units, there are maintenance ports for liquid valve and gas valve. During evacuation, you may connect the two hoses of the branch valve assembly to the maintenance ports to speed up the evacuation.

Refrigerant should be reclaimed into the appropriate storage tank. System should use oxygen-free nitrogen purging to ensure safety. This process may need to repeat several times. Do not use compressed air or oxygen in this process.

4.3 Refrigerant Charging

Pre-charging

Step 1: Connect the high pressure gauge line to the valve of liquid pipe and connect the low pressure gauge line to the valve of gas pipe. Connect the middle gauge line to the vacuum pump. Power on the vacuum pump and perform vacuum drying.

Step 2: After vacuum drying, close the high and low pressure gauge valves. Then remove the middle gauge line from the connector of vacuum pump. Then connect to the refrigerant tank.

Step 3: Loosen the middle gauge line from the connector of pressure gauge to a proper extent and slightly open the valve of refrigerant tank. Evacuate the middle gauge line. Then tighten up the connector again and completely open the valve of refrigerant tank at the same time.

Step 4: Keep the refrigerant tank erect and put it on an electronic scale. Record the current weight as m_1 .

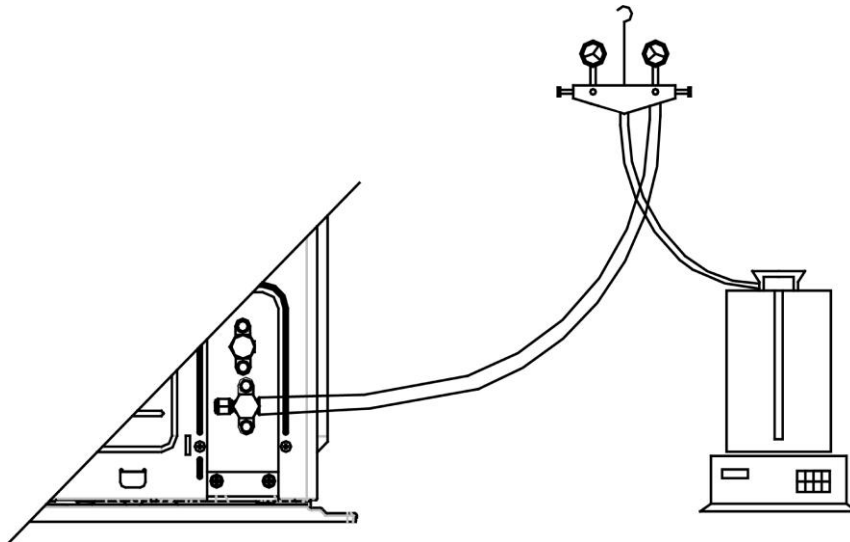

Step 5: Open the high pressure gauge valve (Keep the low pressure gauge valve closed). Then charge refrigerant into the system. Meanwhile, record the weight of refrigerant tank as m_2 .

Step 6: $m_1 - m_2 = m$. If m equals to the required charging quantity M , close the valve of refrigerant tank at once. Then move to step 8.

Step 7: If you can't continue to charge refrigerant into the system and the quantity of charged refrigerant is less than the required charging quantity, then record the current quantity of charged refrigerant:

$$m = m_1 - m_2$$

$$m' = M - m$$

The remaining charging quantity is: $m' = M - m$

Step 8: After charging, remove the pressure gauge.

Refrigerant charging when unit is turned on:

Step 1: Close the valve of refrigerant tank. First remove the pressure gauge lines and connect the outdoor unit to the indoor unit. Then reconnect the pressure gauge lines. Connect the low pressure gauge line to the other joint of gas valve and connect the high pressure gauge line to the liquid valve. Connect the middle gauge line to the vacuum pump. Power on the vacuum pump and perform vacuum drying.

Step 2: After vacuum drying, close the high and low pressure gauge valves. Then remove the middle gauge line from the connector of vacuum pump. Then connect to the refrigerant tank.

Step 3: Loosen the middle gauge line from the connector of pressure gauge to a proper extent and slightly open the valve of refrigerant tank. Evacuate the middle gauge line. Then tighten up the connector again and completely open the valve of refrigerant tank at the same time.

Step 4: Turn on the air conditioner and let it run for a while.

Step 5: Open the low pressure gauge valve (Keep the high pressure gauge valve closed). Then charge in the remaining charging quantity m^{\cdot} .

Step 6: After all required refrigerant is charged in, close the valve of refrigerant tank.

Step 7: Remove the pressure gauge to finish the refrigerant charging work.

Procedure of refrigerant charging

Following is the supplementary requirement for refrigerant charging on the basis of normal procedure:

- 1) Make sure that when charging refrigerant into the system, no other types of refrigerant will be mixed.
The pipeline for refrigerant charging should be as short as possible to reduce the amount of refrigerant left in it.
- 2) The refrigerant tank should stand erect.
- 3) Make sure the refrigerating system is already grounded before refrigerant charging.
- 4) When charging is completed (or not yet completed), stick a label on the system.
- 5) Before re-charging refrigerant into the system, use oxygen-free nitrogen to perform pressure test. When charging is completed, perform leak test before trial running. Before leaving the workplace, perform a leak test again.

4.4 Maintenance of Major Components

4.4.1 Replacement of thermostat

Please refer to the instruction manual of thermostat XE70-00/E1.

4.4.2 How to replace the compressor

4.4.2.1 Diagnosis of compressor failure

A. On condition that the unit can be started up

Step 1:

If the unit can be started up, then start it up to check the current of the faulted compressor. Use a pressure gauge to measure the pressure of the big and small valves. Connect with a computer to monitor the data. Refer to the following table based on the recommended working current. The electric current of an inverter compressor will be different under different rotation speed or different working conditions. If the compressor is working at 60Hz, the working current corresponding to different condensing temperature and evaporating temperature is shown below:

Inverter compressor QXFT-F310zN450

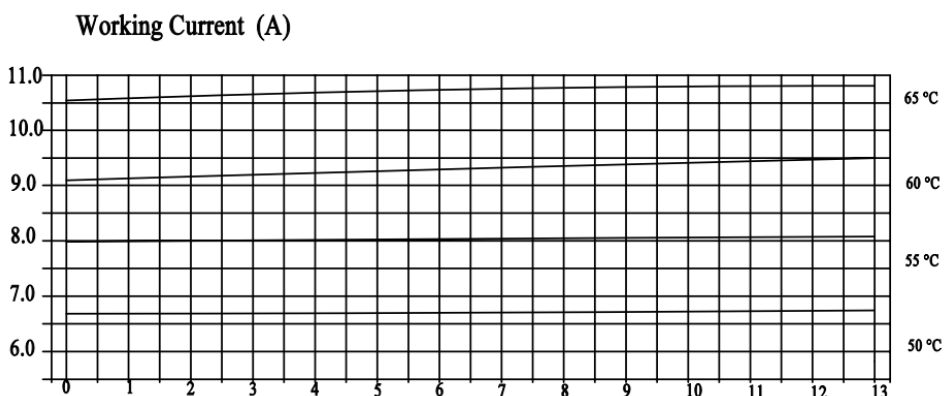

Inverter compressor QXAU-F516zX440A

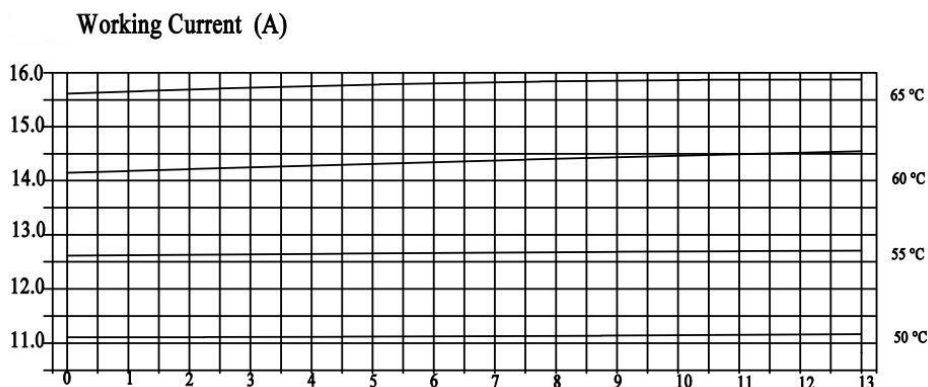

Step 2:

Judge whether the operating noise of the compressor is normal, and whether there is a sharp noise or obvious scraping. If there is a normal compressor working nearby, compare their operating noise.

Step 3:

Examine whether the electronic expansion valve of the outdoor unit is active and whether the 4-way valve works or not. How to examine:

(1) Electronic expansion valve:

The electronic expansion valve will be reset every time when the unit is powered on or off. Touch the valve and you can feel the movement of the valve spool. In the last stage of the reset process, you will hear the click of the valve and feel its vibration.

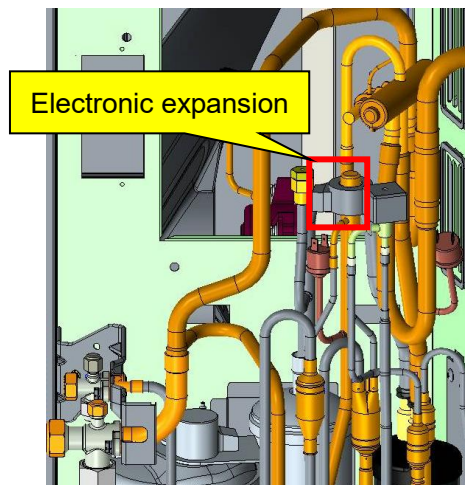

Touch the electronic expansion valve:

- a. Touch the top of the electronic expansion valve and you can feel its move as it is reset upon startup.
- b. Make sure the coil is fixed firmly.

(2) 4-way valve:

During normal operation, the 4 copper tubes that connect to the valve will have different temperature. When the 4-way valve is working, it will generate some noise and vibration.

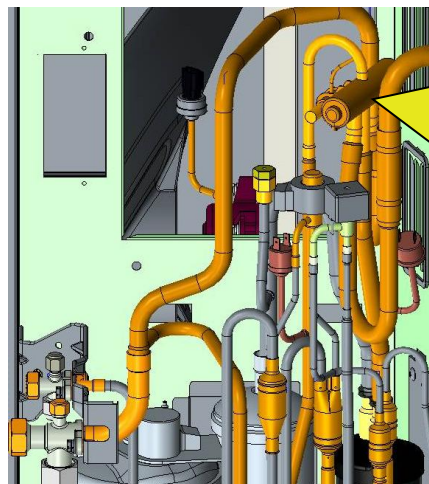

This is the position of the 4-way valve. Do not touch it directly with your hands. There is hot refrigerant at the exhaust pipe, so be careful not to be scalded.

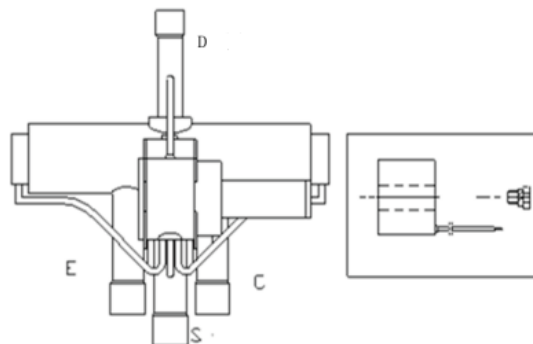

D- Connect to the exhaust side

Caution! High temperature!

Labels on the 4-way valve:

D-connect to the exhaust side; E-connect to the evaporator of indoor unit;

S-connect to the inhalation side of the liquid separator; C-connect to the condenser;

When the system is in cooling mode, C-the pipeline is with high pressure and high temperature; E, S-the pipeline is with low pressure and low temperature;

When the system is in heating mode, E-the pipeline is with high pressure and high temperature; C, S-the pipeline is with low pressure and low temperature;

Because D is connected to the exhaust side, it is with high pressure and high temperature regardless of the operating mode. When the unit is powered on, in defrosting or oil return mode, the 4-way valve will produce some noise. Do not touch the pipes directly with your hands and be cautious of the hot temperature.

Step 4:

Check the drive board of compressor, i.e. the IPM module.

Please refer to the IPM checking method in the section of troubleshooting.

Check the drive board of compressor, i.e. the IPM module.

Please refer to the IPM checking method in the section of troubleshooting.

B. On condition that the unit cannot be started up

Step 1:

Cut off the power supply and detach the cover of the wiring box of the compressor. Check the wiring of the compressor.

Step 2:

Check the resistance between the wiring terminals (U, V, W) of compressor.

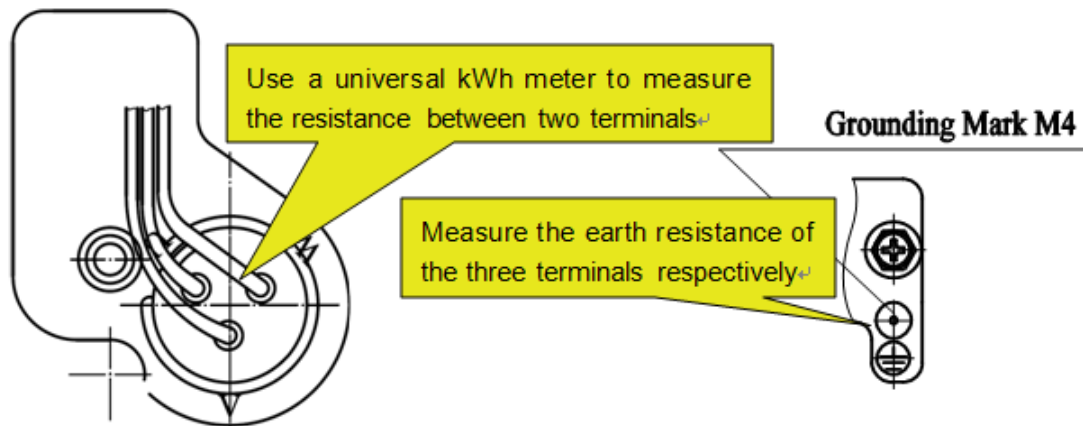

Refer to the following table for the resistance between any two terminals:

Compressor model	UV Winding resistance	VW Winding resistance	WU Winding resistance
QXFT-F310zN450	0.79±7%Ω	0.79±7%Ω	0.79±7%Ω
QXAU-F516zX440A			

Measure the earth resistance of each wiring terminal. The resistance should be above 10 megohm. If not, we can judge that the compressor is faulted inside.

Step 3:

On condition that the unit cannot be started up, we also need to check the solenoid valve assembly of the system, including the electronic expansion valve. The checking method is the same as instructed above.

Step 4:

Check whether the IPM module is normal. Please refer to the IPM checking method in the section of troubleshooting.

4.4.2.2 Replacement of compressor

Step 1: Preparation

(1) Prepare the components for replacement

When carrying the old and new compressors, do not place the compressors horizontally or upside down. The angle of inclination should be within $\pm 30^\circ$. Make sure the lubricant inside the compressors will not flow from the oil

balance mouth. The suction and exhaust openings of the compressors must be sealed. If a rubber seal is missing, user adhesive tape to seal the opening. This is to prevent the compressor oil from contacting the air.

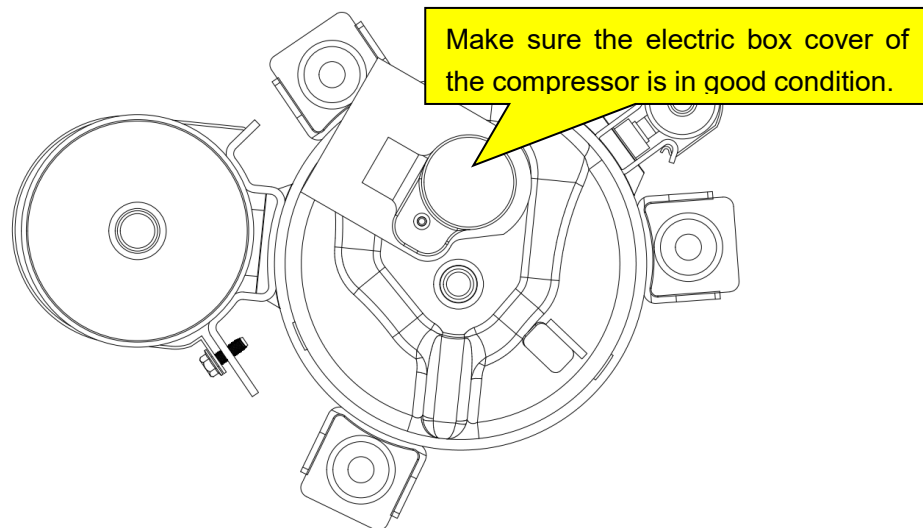
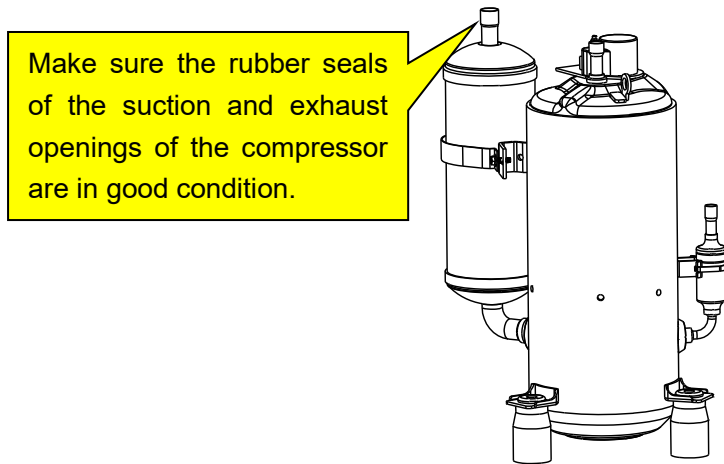

NOTICE: Before replacement, make sure the nameplates and models of the compressors are identical.



NOTICE: Make sure the lubricant is sealed inside the compressors.

(2) Prepare relevant tools

- 1) Prepare nitrogen. Please strictly follow the nitrogen welding standards during the welding process. Make sure there is sufficient nitrogen. The nitrogen pressure should be above 2.0MPa;
- 2) Prepare welding rods. Prepare some welding rods of common specifications and some special welding rods that contain more than 5% silver. They are used to weld the compressor. The suction and exhaust openings of the compressor are all connected to copper-plated steel pipes, so we need to use special welding rods and solder;
- 3) Prepare applicable welding tools. Please evaluate how much oxygen and acetylene should be used according to the current welding condition. Try to avoid repeated welding.
- 4) Prepare a complete set of tools, including an internal hexagonal wrench, diagonal pliers, pincer pliers, nipper pliers, a universal meter, a pressure gauge, cross screwdriver, straight screwdriver, more than two wrenches, insulating tape and wire cables.

Step 2: Disconnect power

If the compressor needs to be replaced after judging as above, then switch off the outdoor unit and disconnect the power cable of the outdoor unit. Use insulating tape to wrap the power cable and put a notice board on the power switch to remind people to be cautious of electric shock.

Step 3: Neaten the electric components

When you detach the compressor wires, temperature sensors and electric heaters, mark them correspondingly for the convenience of reconnecting them.

Step 4: Discharge refrigerant

Discharge refrigerant from the system. Discharge simultaneously from the high pressure side and low pressure side. Do not discharge too fast (It should take more than 12h to completely discharge the refrigerant); otherwise, large quantity of lubricant will escape from the system together with the refrigerant.

Step 5: Detach the compressor

Check the condition of the damaged compressor, including its position and model.

If the information of the compressor is confirmed, check the oil quality.

(a) If the oil is clear and impurities-free, we consider that the oil of the system is not polluted. Meanwhile, if we confirm that the valves and pipes are also normal, then we can replace the compressor only. For the removal of compressor, please refer to the section: Removal of Major Components.

How to check oil quality:

- (1) After the compressor is detached, put it on a solid ground and shake it at an angle of 30~45° to ensure that the contaminant at the bottom of the compressor can be poured out.

- (2) Place the compressor at a position above the ground level and then pour out the oil from the air outlet of the compressor. Collect the oil in a transparent container. The amount of oil should be over 150ml.

NOTE:

- 1) The axial direction of the compressor should not slant at an angle larger than 20° to the horizontal direction.
 - 2) Prevent the compressor from falling.
 - 3) Put a transparent container (over 150ml in volume) under the exhaust pipe to collect the compressor oil, thus we can see the oil quality.
- (3) Put the container of compressor lubricant in a bright location and see if there is impurity and discoloration. Sniff at the compressor lubricant. Normally, there is no pungent smell.
- (b) If the oil is contaminated, replace the compressor and the gas-liquid separator.

NOTE: Confirm whether the compressor needs to be replaced. The pipe mouths of the faulted compressor must be sealed by adhesive tape as soon as the compressor is detached. Make sure the compressor is well preserved for the ease of future analysis.

Step 6: Check the components

If the oil is contaminated, check the components of the unit, including the gas-liquid separator.

Check the gas-liquid separator

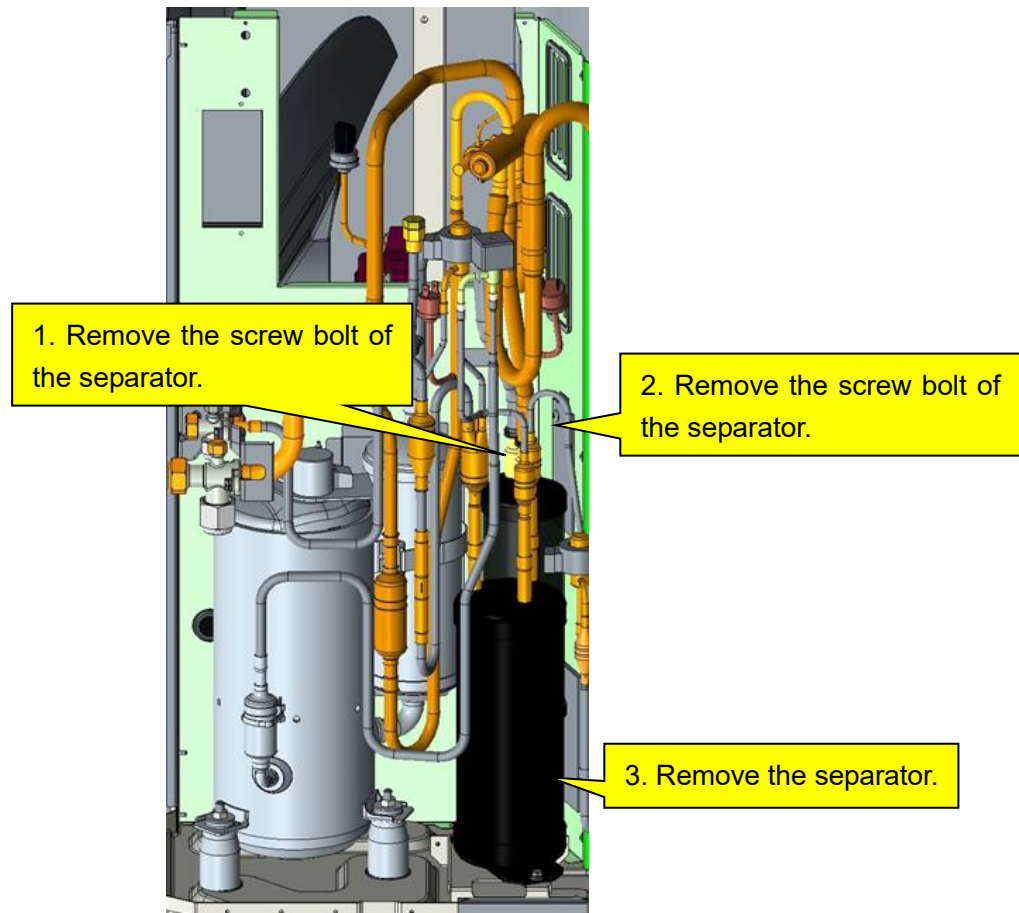

When the separator is detached, check whether there are impurities inside. Below is the checking method:

NOTE:

When pouring the liquid from the separator, make sure the discharge pipe is at the lower position. Slant at an angle not larger than 20°

Use a transparent container to collect the content inside the separator. Check its color, seal it well and return it to the factory for inspection.

NOTE:

If the compressor is damaged and needs to be replaced, the gas-liquid separator should also be replaced, whether or not there are impurities in the separator or other abnormal conditions.

Confirm which parts of the system should be replaced. Make sure the pipe mouths of the damaged parts or components are sealed by adhesive tape as soon as they are detached. Keep them in the original condition for future analysis.

Step 7: Clear the pipeline

After confirming which parts of the system should be replaced, check the pipeline of the system. Blow through the main pipeline with nitrogen. After clearing the pipeline, if the components are not replaced immediately, seal the pipeline with adhesive tape to prevent the system from being contaminated by water and impurities in the air.

Step 8: Replace the compressor

For the removal of compressor, please refer to the section: Removal of Major Components.

Step 9: Check/Replace the gas-liquid separator

NOTE:

If a compressor is damaged and needs to be replaced, its gas-liquid separator should also be replaced. This is to avoid the abnormal condition of the separator from affecting the safe and reliable operation of the system.

For the removal of gas-liquid separator, please refer to the section: Removal of Major Components.

Step 10: Check the system for leaks

- (1) First of all, check each welding point. Check whether the welding points are smooth and whether there is any obvious welding hole or other abnormal condition.
- (2) Next, fill high-pressure nitrogen into the system for leak detection. If it is only the outdoor unit that needs to be repaired and the indoor unit is confirmed normal, then it's OK to charge high-pressure nitrogen into the outdoor unit only. Fill in the nitrogen simultaneously from the high pressure side and low pressure side. We recommend charging the nitrogen from the big and small valves at the same time. The pressure of nitrogen should be above 20kgf. Then use soapy water to check for leaks. Check the welding points particularly.
- (3) Finally, retain the pressure of the system. Fill high-pressure nitrogen into the system and maintain the pressure above 25kgf. Close the big and small valves and keep the pressure of indoor and outdoor units for more than 12h. If the pressure remains unchanged, then start vacuum pumping; otherwise, check the system for leaks again.

Temperature should be considered when judging the pressure change. If temperature changes by 1°C, pressure will change by 0.01MPa or so.

For example, if temperature is 30°C when nitrogen of 2.5MPa is charged, and temperature changes to 25°C after 12h, we consider that the system is qualified if the pressure is found at 2.43MPa or above.

Step 11: Evacuate the system and charge refrigerant

Please refer to the section of maintenance: vacuum pumping and refrigerant charging.

Step 12: Connect electric components

Connect cables, compressor wires and the electric heating belt according to the signs marked before and the wiring diagram on the cover of the electric box.

4.4.3 How to replace the drive module of compressor

Step 1: First, make sure that power is cut off. Set the universal meter at the AC voltage and measure the voltage between L1, L2, L3, and N. If each time the voltage is 0V (Errors may occur to the universal meter, sometimes the voltage may not be 0V), proceed with the next step and put a sign on the power switch that reads “Under maintenance, don’t switch on”.

Step 2: Measure the voltage between DC bus P and N on the drive board of the compressor. Set the universal meter at the DC voltage and measure the voltage between P and N as shown below. If the voltage is below 36V, proceed with the next step. In case that a universal meter is not available, disconnect power for 20min and then continue with the next step.

Step 3: Remove all the wires on the drive board of the compressor.

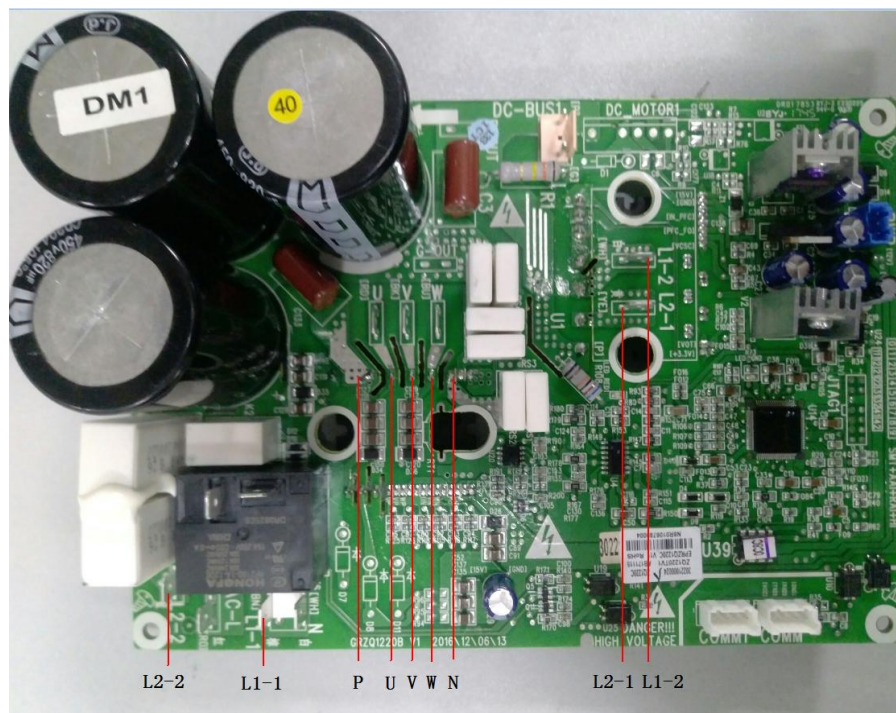



Step 4: Remove the screws on the drive board of the compressor. The screws are located in the white circles as shown above in the picture.

Step 5: Replace with a new compressor drive board. Before replacement, apply some silica gel on the IPM module.

Step 6: Install the new compressor drive board. Fix the screws and connect the wires correctly.

4.5 Removal of Major Components

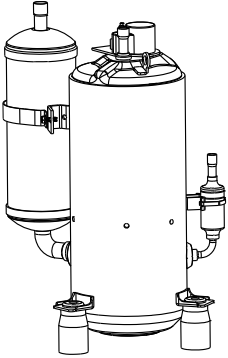
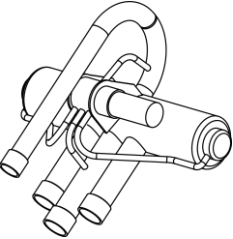
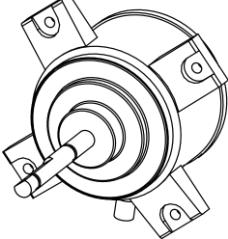
4.5.1 Removal of ODU Major Components

Picture	Name	Function
	Compressor	<p>Through compression, the low pressure refrigerant occupies a less space. As its pressure and temperature both rise, it becomes high pressure and high temperature refrigerant. It is the power drive of the system.</p>
	4-way valve	<p>It is used to change directions, the flow of refrigerant in cooling/heating.</p>
	Motor	<p>The power drive of the fan. It enables the fan to run so as to provide smooth currents of air for forced convection and heat exchange of condenser and evaporator.</p>
	Fan	<p>It is used to provide smooth currents of air for forced convection and heat exchange of condenser and evaporator.</p>
	Gas liquid separator	<p>Installed at the suction side of compressor, it can separate the liquefied refrigerant from the gaseous refrigerant to make sure that only gaseous refrigerant will be sucked into the compressor. If liquefied refrigerant gets inside the compressor, ineffective compressor or slugging phenomenon will occur.</p>

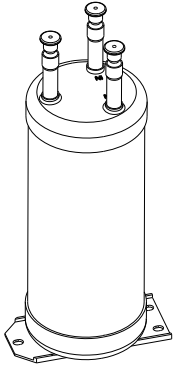
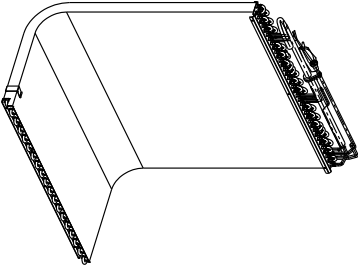
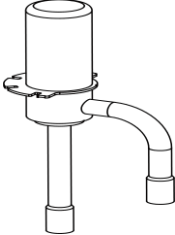
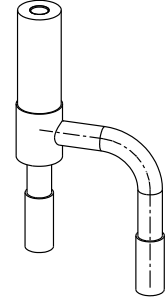
Picture	Name	Function
	Accumulator	Flash refrigerant from liquid to gas
	Condenser	It is used to transfer partial heat of the hot flow to the cold flow so that the flow temperature can reach the specified index. It is an energy exchanging device.
	Electronic expansion valve	It is used to lower the pressure and temperature of liquefied refrigerant and adjust the flow of refrigerant entering the evaporator.
	Electromagnetic Valve	Electromagnetic valve controls increased enthalpy switch.

Model:FLEXX36HP230V1AO

Removal of front panel

NOTE: Before removing the front panel, make sure power is cut off.

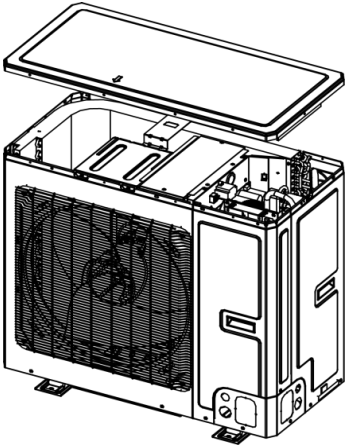
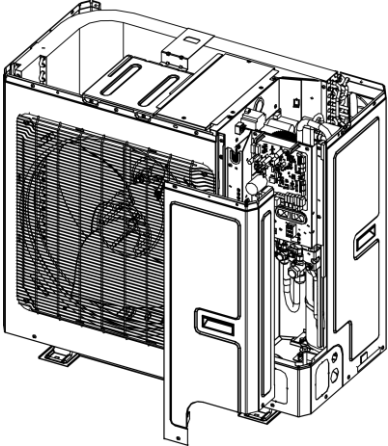
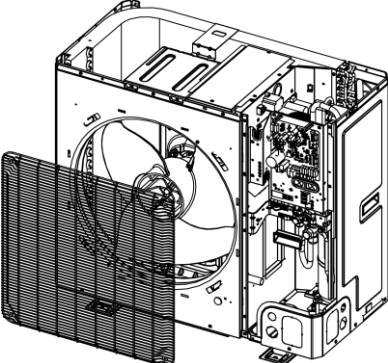
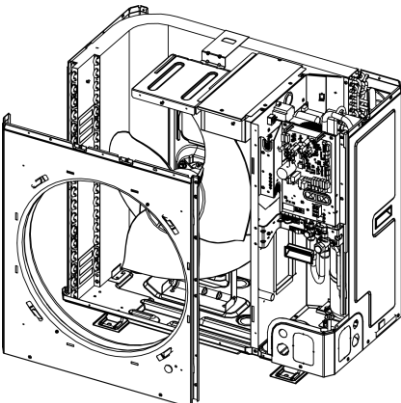
Step	Picture	Work instruction
1. Remove the upper cover plate.		<ul style="list-style-type: none"> ● Unscrew the screws of the upper cover plate with a screwdriver.
2. Remove the front side plate.		<ul style="list-style-type: none"> ● Unscrew the screws of the upper and front side plate with a screwdriver.
3. Remove the front grill.		<ul style="list-style-type: none"> ● Unscrew the screws of the front grill with a screwdriver.
4. Remove the front panel.		<ul style="list-style-type: none"> ● Unscrew the screws that connect the front panel to the middle insulating board and screws around the front panel.

Removal of front panel

NOTE: Before removing the front panel, make sure power is cut off.

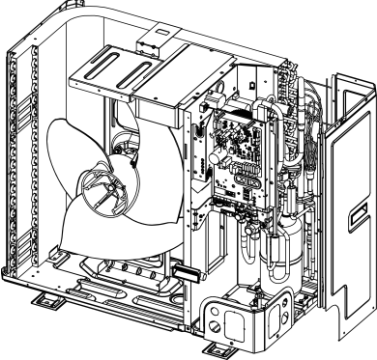
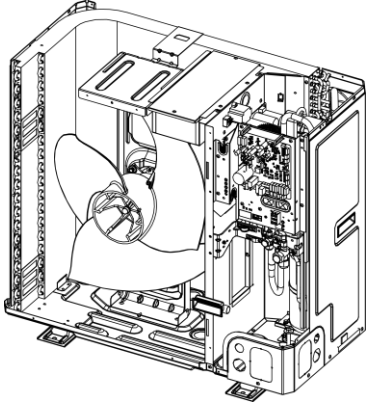
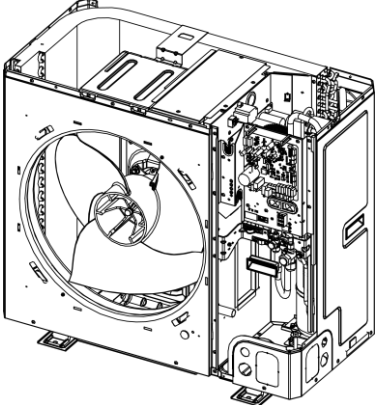
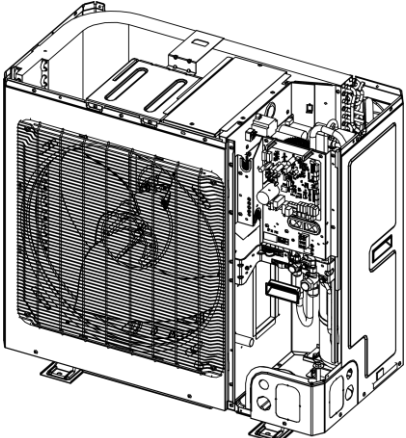
Step	Picture	Work instruction
5. Remove the right side plate.		<ul style="list-style-type: none"> ● Unscrew the screws that connect the right side plate to the electric box and the screws around the right side plate.
6. Install the right side plate		<ul style="list-style-type: none"> ● Screw up the screws around the right side plate. Be careful to handle well the clasps at the bottom of the right side plate.
7. Install the front panel.		<ul style="list-style-type: none"> ● Install the front panel by mounting on 6 clasps on its both sides. Please note that there is one screw on the lower right side.
8. Install the grill.		<ul style="list-style-type: none"> ● Attach the grill back in place and tighten up the screws.

Removal of front panel

NOTE: Before removing the front panel, make sure power is cut off.

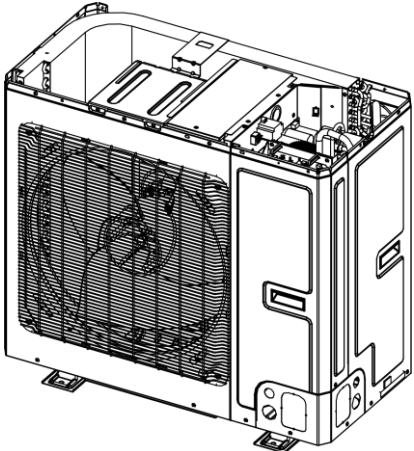
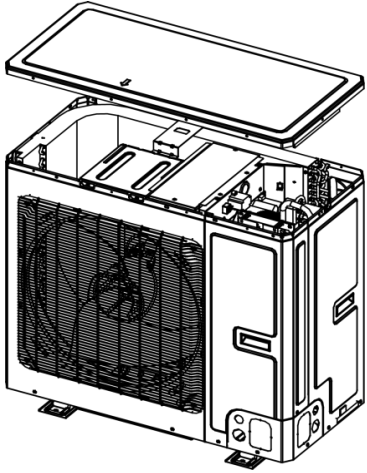
Step	Picture	Work instruction
<p>9. Install the front side plate.</p>		<ul style="list-style-type: none"> ● Fix the clasps on both sides of the plate and tighten up the screws.
<p>10. Install the upper cover plate.</p>		<ul style="list-style-type: none"> ● Tighten up the screws around the upper cover plate.

Model: FLEXX36HP230V1AO

Removal of compressor/gas liquid separator

NOTE: Before removing the compressor/gas liquid separator, make sure there is no refrigerant in the pipeline and power is cut off.

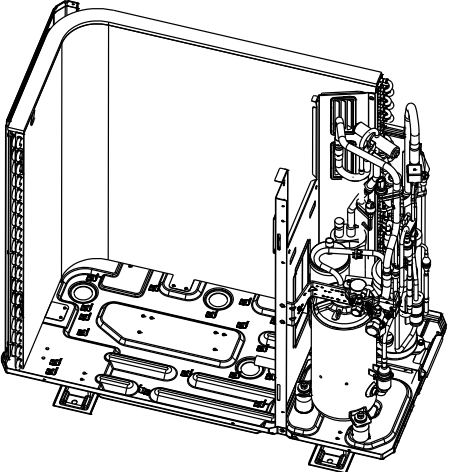
Step	Picture	Work instruction
<p>1. Remove wires.</p>		<ul style="list-style-type: none"> ● Loosen the securing screws of the wires with a screwdriver. ● Remove the wires. NOTE: When removing the wires, mark the wire terminals corresponding to their color so as to avoid misconnection.

Removal of compressor/gas liquid separator

NOTE: Before removing the compressor/gas liquid separator, make sure there is no refrigerant in the pipeline and power is cut off.

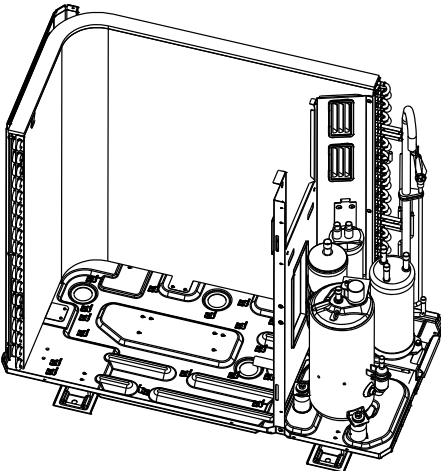
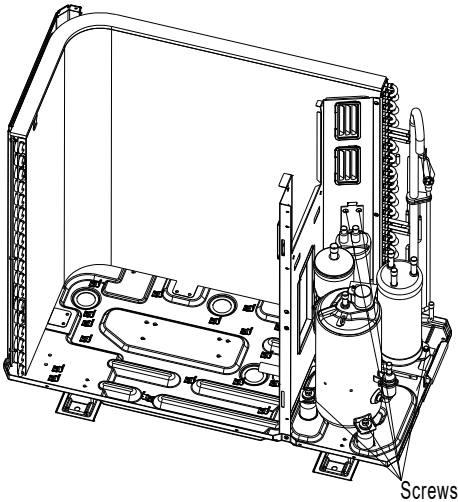
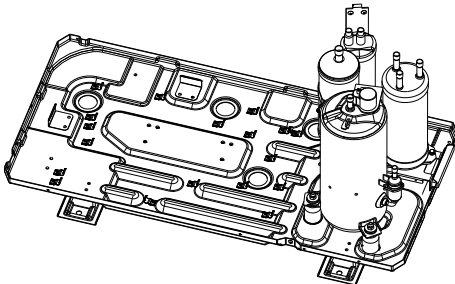
Step	Picture	Work instruction
<p>2. Break off the pipes that connecting to the compressor/gas liquid separator.</p>		<ul style="list-style-type: none"> Weld the pipes that are connected to the compressor/gas liquid separator. Then remove the pipes. NOTE: When welding the pipes, do not let the flame burn the other components.
<p>3. Loosen the compressor's base connectors / gas liquid separator's base nuts.</p>		<ul style="list-style-type: none"> Use a wrench to twist off the compressor/gas liquid separator's base nuts.
<p>4. Remove the compressor/gas liquid separator from the chassis.</p>		<ul style="list-style-type: none"> Take away the compressor/gas liquid separator and replace with a new one. NOTE: When replacing the compressor/gas liquid separator, avoid touching the nearby pipeline and components.

Removal of compressor/gas liquid separator

NOTE: Before removing the compressor/gas liquid separator, make sure there is no refrigerant in the pipeline and power is cut off.

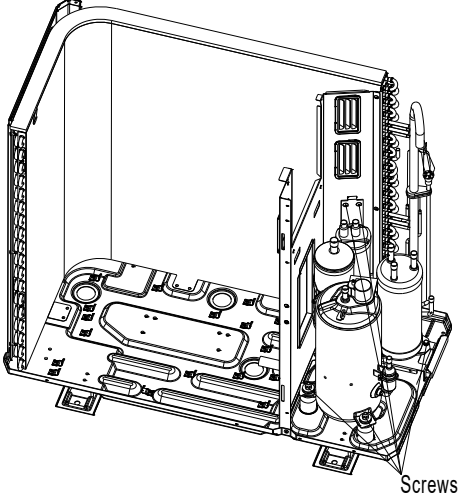
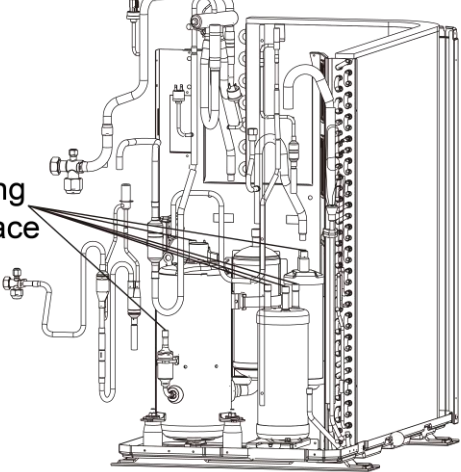
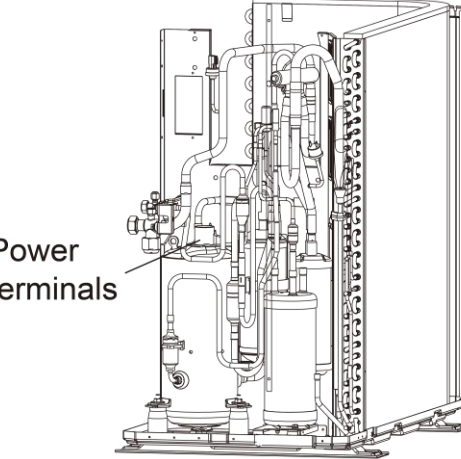
Step	Picture	Work instruction
<p>5. Install the new compressor/gas liquid separator onto the chassis.</p>		<ul style="list-style-type: none"> ● After replacing the compressor/gas liquid separator, tighten up the base screw nuts.
<p>6. Connect the welding interfaces of compressor/gas liquid separator to the pipeline.</p>		<ul style="list-style-type: none"> ● Weld the connection pipes of compressor so as to connect them to the compressor. <p>NOTE: When replacing the compressor, avoid touching the nearby pipeline and components.</p>
<p>7. Connect the compressor wires.</p>		<ul style="list-style-type: none"> ● Connect the compressor wires to the wire terminals on the top of compressor. <p>NOTE: When connecting the wires, be sure to match the colors with the corresponding wire terminals.</p>

Model: FLEXX36HP230V1AO

Removal of 4-way valve

NOTE: Before removing the 4-way valve, make sure refrigerant is fully discharged from the unit and power is cut off.

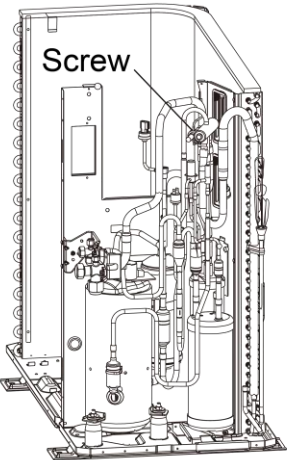
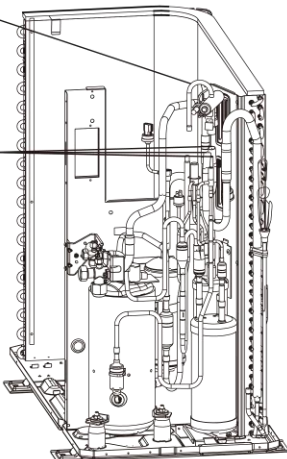
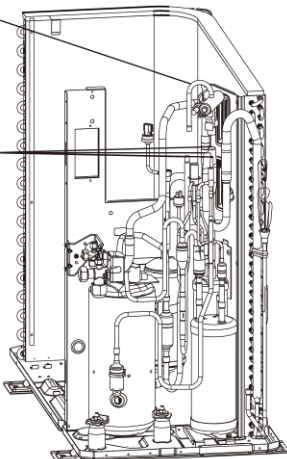
Step	Picture	Work instruction
<p>1. Take off the coil of the 4-way valve.</p>		<ul style="list-style-type: none"> Carefully unscrew the screws of electromagnetic coil with a screwdriver.
<p>2. Break off the connection pipes from the 4-way valve.</p>		<ul style="list-style-type: none"> Use a soldering gun to loosen the 4 joints on the 4-way valve and then remove the connection pipes. NOTE: When welding the pipes, the 4-way valve should be wrapped with wet cloth for cooling. Do not let the flame burn the other components.
<p>3. Replace the 4-way valve and connect it to the connection pipes.</p>		<ul style="list-style-type: none"> Replace the 4-way valve and then use a soldering gun to weld the 4 joints of the 4-way valve. NOTE:When welding the pipes, the 4-way valve should be wrapped with wet cloth for cooling. Do not let the flame burn the other components.

Removal of 4-way valve

NOTE: Before removing the 4-way valve, make sure refrigerant is fully discharged from the unit and power is cut off.

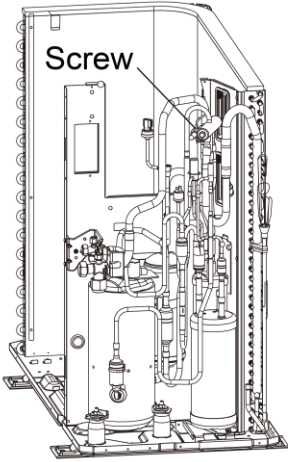
Step	Picture	Work instruction
<p>4. Install the coil of 4-way valve.</p>		<ul style="list-style-type: none"> ● Tighten the screws of the coil of 4-way valve with a screwdriver.

Model: FLEXX36HP230V1AO

Removal of fan and motor

Note: Before removing the fan, make sure power is cut off.

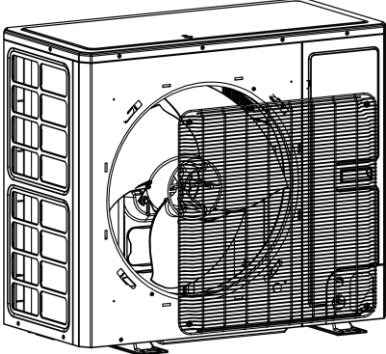
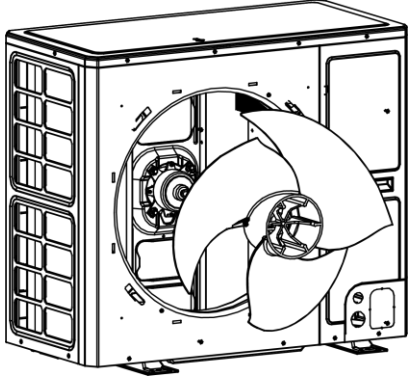
Step	Picture	Work instruction
<p>1. Remove the grill.</p>		<ul style="list-style-type: none"> ● Use a screwdriver to unscrew the two screws on the upper left and lower right corners.
<p>2. Remove the fan.</p>		<ul style="list-style-type: none"> ● Use a wrench to remove the specialized nut and gasket of the fan. NOTE: Please keep the nut and gasket safe after removing them from the fan.

Removal of fan and motor

Note: Before removing the fan, make sure power is cut off.

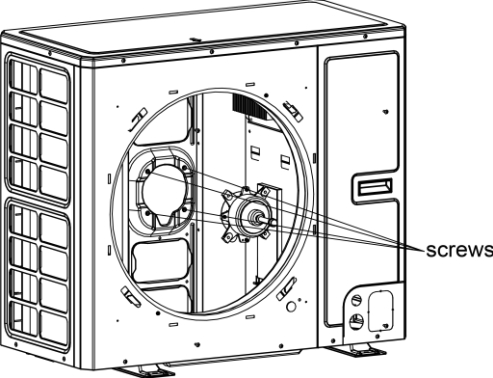
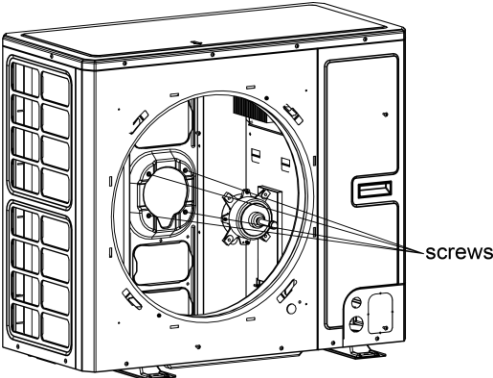
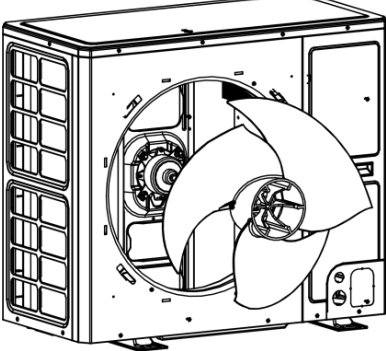
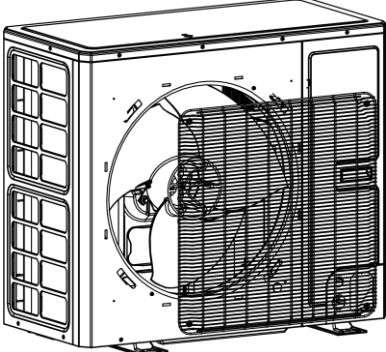
Step	Picture	Work instruction
3. Remove motor.		<ul style="list-style-type: none"> ● Use a screwdriver to unscrew the bolt of motor. NOTE: Motor wire should be first removed from the electric box.
4. Install the motor.		<ul style="list-style-type: none"> ● Replace with a new motor. Then tighten up the screw bolt.
5. Install the fan.		<ul style="list-style-type: none"> ● Install the fan in place. Put on the gasket and use a wrench to secure the screw nut. NOTE: After installing the fan, turn the fan by hand to see if it can run normally. If not, please check for the reason.
6. Install the grill.		<ul style="list-style-type: none"> ● After replacing the motor, use a screwdriver to tighten up the screw bolt that secures the motor. Arrange the wires according to the wiring diagram.

Model: FLEXX36HP230V1AO

Removal of condenser

NOTE: Before removing the condenser, make sure there is no refrigerant in the pipeline and power is cut off.

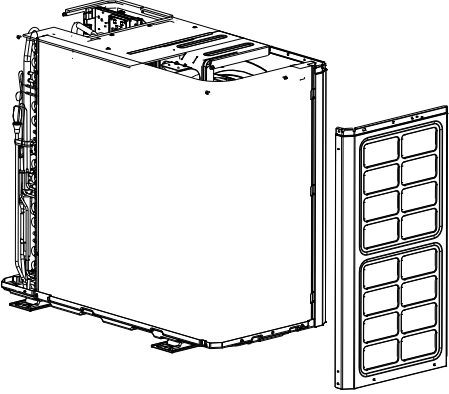
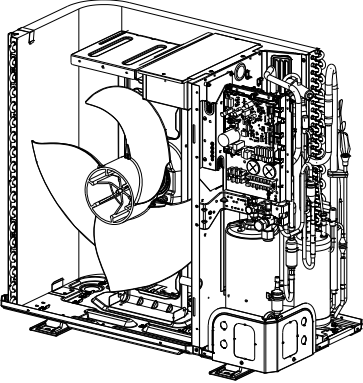
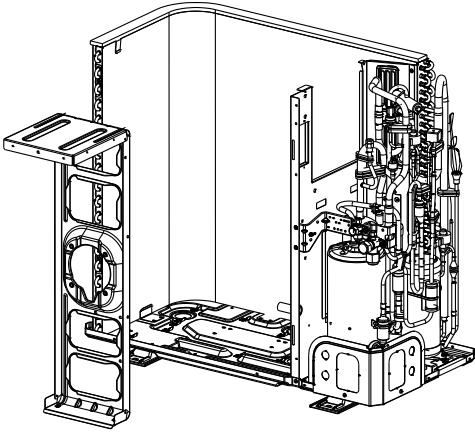
Step	Picture	Work instruction
1. Remove the panels.		<ul style="list-style-type: none"> ● Remove the upper, lower and front panels.
2. Remove the electric box.		<ul style="list-style-type: none"> ● Loosen the wire clamp at the bottom of the electric box. ● Unscrew the screws of electric box. ● The connection wires inside and outside the electric box should be removed.
3. Remove motor support.		<ul style="list-style-type: none"> ● When removing the motor support, be careful to protect the components.

Removal of condenser

NOTE: Before removing the condenser, make sure there is no refrigerant in the pipeline and power is cut off.

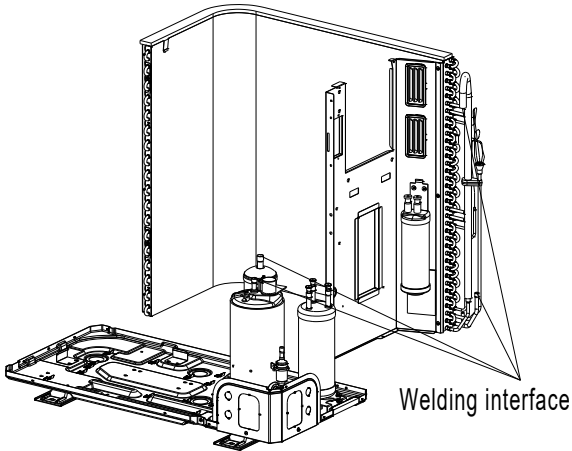
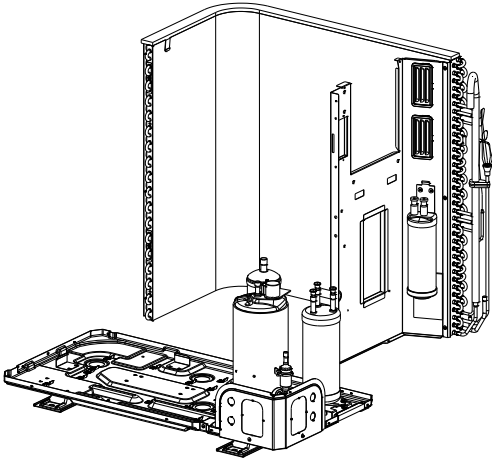
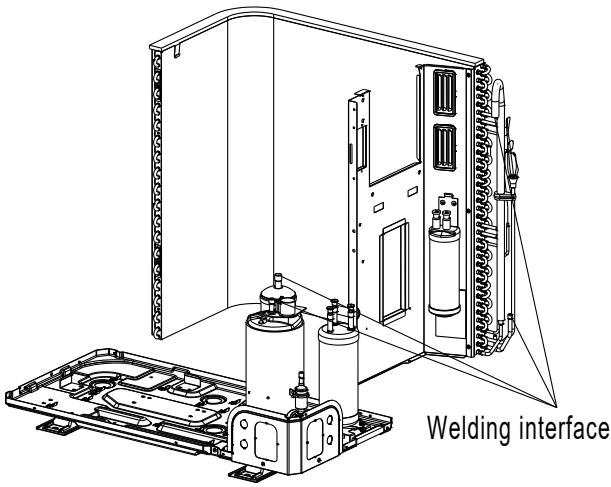
Step	Picture	Work instruction
<p>4. Remove the condenser.</p>		<ul style="list-style-type: none"> ● Heat up the welding points of connection pipes through gas welding until the pipes break off. NOTE: When welding the pipes, do not let the flame burn the other components. The welding points of condenser are steel and copper welding points. Be sure to maintain the welding quality.
<p>5. Take out the condenser.</p>		<ul style="list-style-type: none"> ● Loosen the securing screws of condenser support. Take off the plate type heat exchanger and the support as a whole.
<p>6. Install the new condenser.</p>		<ul style="list-style-type: none"> ● Secure the screws of condenser and support. Then fix them together on the chassis. ● Install the condenser by referring to the positions of entering and leaving pipes. Weld the connection pipes. ● Nitrogen welding: the pressure of nitrogen is $0.5 \pm 0.1 \text{ kgf/cm}^2$ (relative pressure). NOTE: When welding the pipes, do not let the flame burn the other components.

Removal of condenser

NOTE: Before removing the condenser, make sure there is no refrigerant in the pipeline and power is cut off.

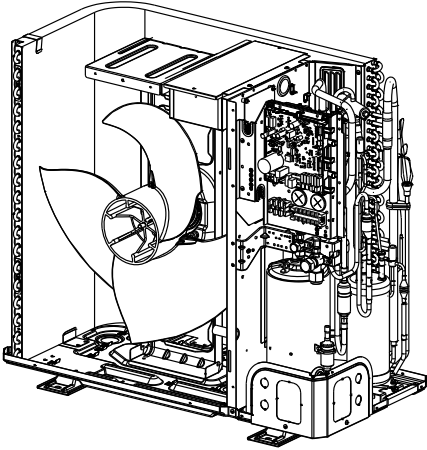
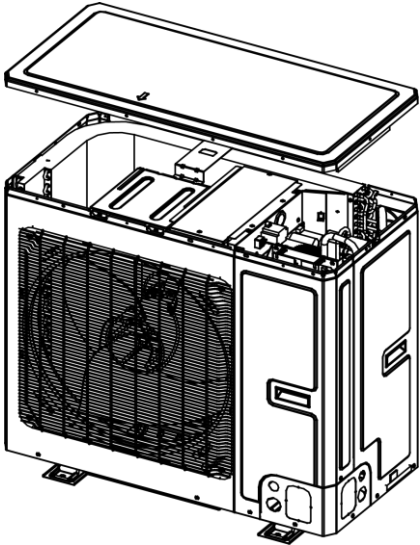
Step	Picture	Work instruction
<p>7. Secure the electric box and arrange the wires according to the requirement.</p>		<ul style="list-style-type: none"> ● Put the electric box in place and tighten up the screws of electric box. ● Arrange and secure the wires as original.
<p>8. Check and open the upper and side panels.</p>		<ul style="list-style-type: none"> ● Check whether each component and connection wire is well connected. ● If everything is OK, place back the upper, left and right side panels.

Model: FLEXX36HP230V1AO

Removal of electronic expansion valve

NOTE: Before removing the electronic expansion valve, make sure there is no refrigerant in the pipeline and power is cut off.

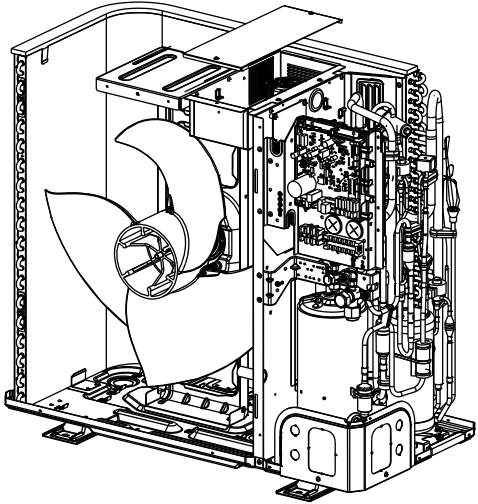
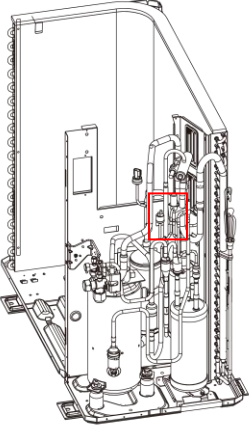
Step	Picture	Work instruction
1. Remove the electric box.		<ul style="list-style-type: none"> ● Remove the upper, lower and front panels. ● Loosen the wire clamp at the bottom of the electric box ● Unscrew the screws of electric box. ● The connection wires inside and outside the electric box should be removed. ● When removing the electric box, be careful to protect the components.
2. Remove the fixed block.		<ul style="list-style-type: none"> ● Remove the fixed block between the electronic expansion valve and the pipe.

Removal of electronic expansion valve

NOTE: Before removing the electronic expansion valve, make sure there is no refrigerant in the pipeline and power is cut off.

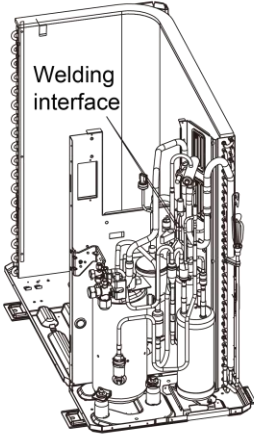
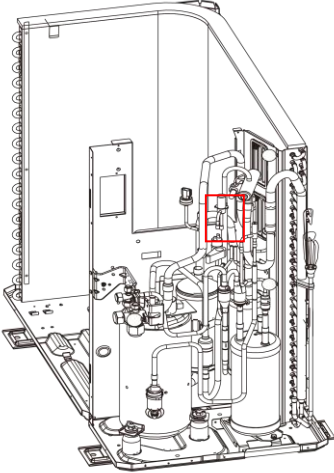
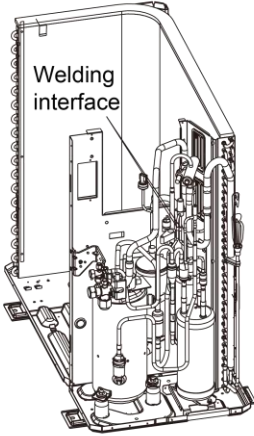
Step	Picture	Work instruction
3. Remove the electronic expansion valve.		<ul style="list-style-type: none"> ● Take off the coil of electronic expansion valve. ● Loosen the connection pipe of electronic expansion valve by welding. Then remove the connection pipe. <p>NOTE: When welding the pipe, do not let the flame bunt the other components.</p>
4. Take out the electronic expansion valve.		<ul style="list-style-type: none"> ● Take out the electronic expansion valve.
5. Install the new electronic expansion valve.		<ul style="list-style-type: none"> ● Weld the connection pipe of electronic expansion valve. ● When welding the electronic expansion valve, the valve should be wrapped with wet cloth. ● Nitrogen welding: the pressure of nitrogen is $0.5 \pm 0.1 \text{ kgf/cm}^2$ (relative pressure). NOTE: When welding the pipes, do not let the flame burn the other components. ● Install the coil of electronic expansion valve.

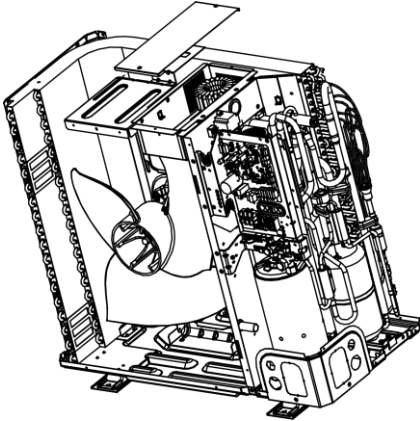
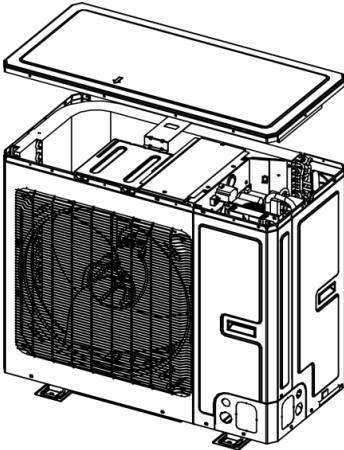
Removal of electronic expansion valve		
NOTE: Before removing the electronic expansion valve, make sure there is no refrigerant in the pipeline and power is cut off.		
Step	Picture	Work instruction
6. Secure the electric box and arrange the wires as required.		<ul style="list-style-type: none"> ● Put the electric box back in place and tighten up the screws. ● Arrange the wires as original.
7. Check and open the upper and front panels.		<ul style="list-style-type: none"> ● Check whether each component and connection wire is well connected. ● If everything is OK, install the upper, left and right panels. Tighten up the screws.

Model: FLEXX60HP230V1AO

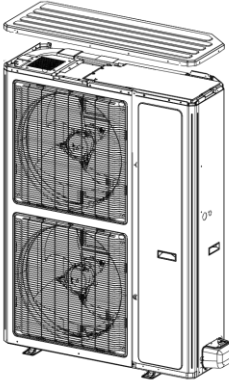
Removal of front panel		
NOTE: Before removing the front panel, make sure power is cut off.		
Step	Picture	Work instruction
1. Remove the upper cover plate.		<ul style="list-style-type: none"> ● Unscrew the screws of the upper cover plate with a screwdriver.

Removal of front panel

NOTE: Before removing the front panel, make sure power is cut off.

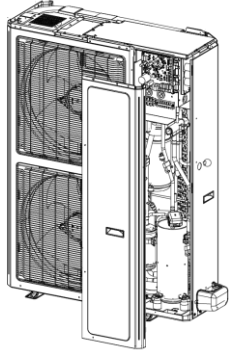
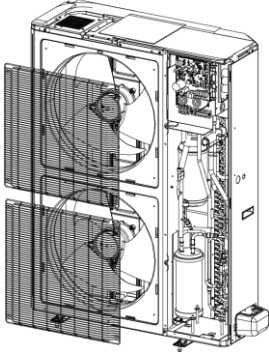
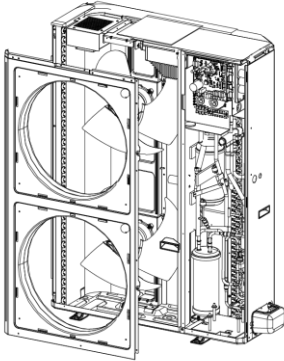
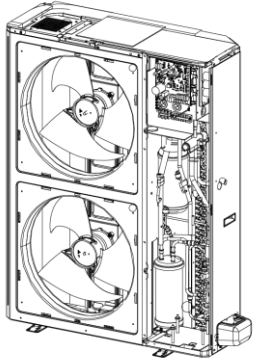
Step	Picture	Work instruction
2. Remove the front plate.		<ul style="list-style-type: none"> ● Unscrew the screws of the front plate with a screwdriver.
3. Remove the front grill.		<ul style="list-style-type: none"> ● Unscrew the screws of the front grill with a screwdriver.
4. Remove the front panel.		<ul style="list-style-type: none"> ● Unscrew the screws that connect the front panel to the middle insulating board and screws around the front panel.
5. Install the front panel.		<ul style="list-style-type: none"> ● Install the front panel by mounting on 6 clasps on its both sides. Please note that there is one screw on the lower right side.

Removal of front panel

NOTE: Before removing the front panel, make sure power is cut off.

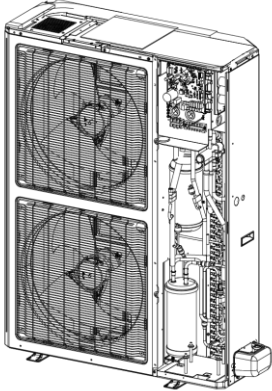
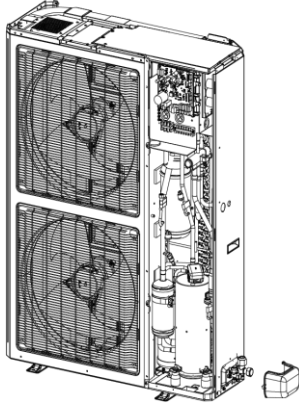
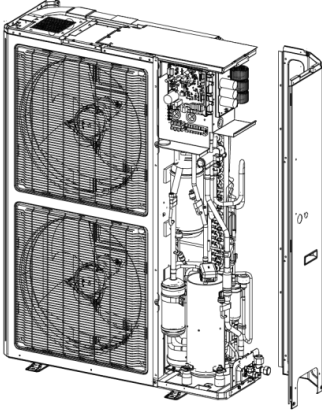
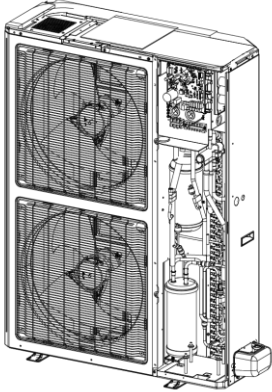
Step	Picture	Work instruction
6. Install the grill.		<ul style="list-style-type: none"> ● Attach the grill back in place and tighten up the screws.
7. Remove the valve cover		<ul style="list-style-type: none"> ● Unscrew the screws of the valve cover with a screwdriver.
8. Remove the right side plate.		<ul style="list-style-type: none"> ● Unscrew the screws that connect the right side plate to the electric box and the screws around the right side plate.
9. Install the right side plate.		<ul style="list-style-type: none"> ● Screw up the screws around the right side plate. Be careful to handle well the clasps at the bottom of the right side plate.

Removal of front panel

NOTE: Before removing the front panel, make sure power is cut off.

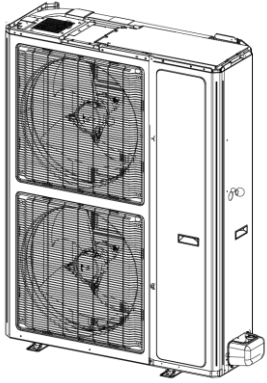
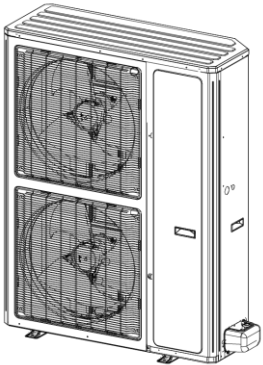
Step	Picture	Work instruction
10. Install the grill.	 A technical line drawing of a vertical DC inverter heat pump condensing unit. The unit has two large fans on the left side, each covered by a square grill. The right side of the unit is a solid vertical panel. The unit is mounted on four small feet at the base.	<ul style="list-style-type: none">● Attach the grill back in place and tighten up the screws.
11. Install the upper cover plate.	 A technical line drawing of the same condensing unit as in the previous step. In addition to the grills, a horizontal cover plate is now installed over the top of the unit, covering the upper fan area and the top of the right-side panel.	<ul style="list-style-type: none">● Tighten up the screws around the upper cover plate.

Model: FLEXX60HP230V1AO

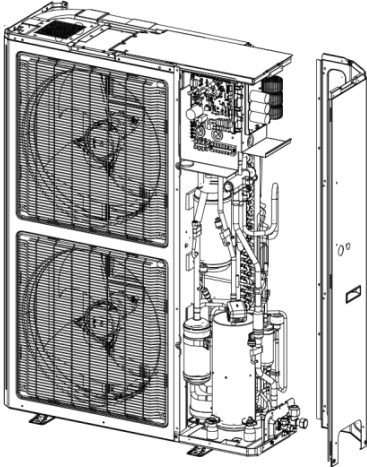
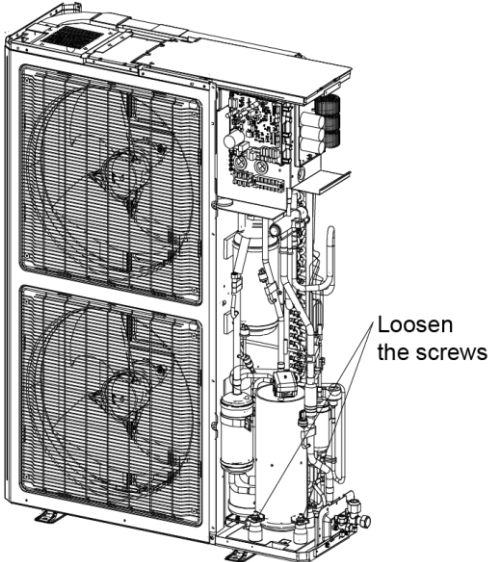
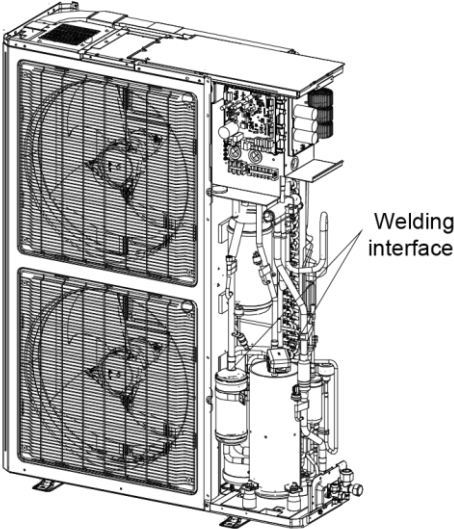
Disassembly of compressor		
NOTE: Before removing the compressor, make sure there is no refrigerant in the pipeline and power is cut off.		
Step	Picture	Work instruction
1. Remove wires.		<ul style="list-style-type: none"> Loosen the securing screws of the wires with a screwdriver. Remove the wires. <p>NOTE: When removing the wires, mark the wire terminals corresponding to their color so as to avoid misconnection.</p>
2. Loosen the securing screws at the foot of compressor.		<ul style="list-style-type: none"> Use a wrench to twist off the screw nuts at the foot of compressor.
3. Break off the pipes that connecting to the compressor.		<ul style="list-style-type: none"> Weld the pipes that are connected to the compressor. Then remove the pipes. <p>NOTE: When welding the pipes, do not let the flame burn the other components.</p>

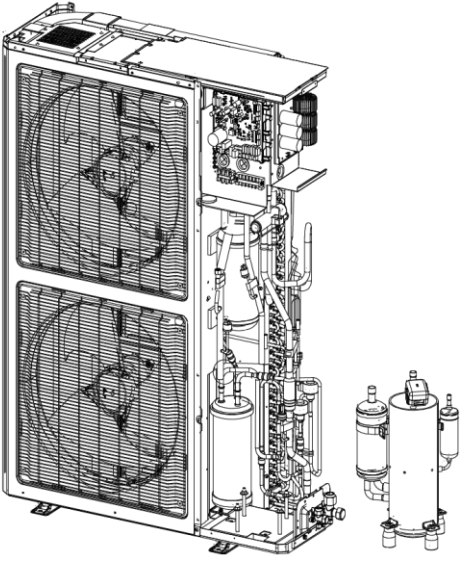
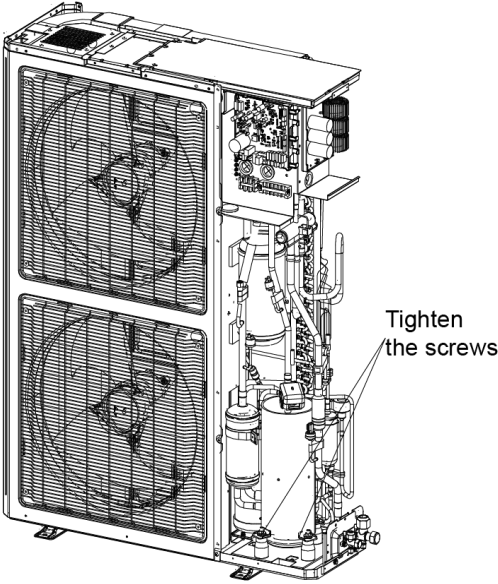
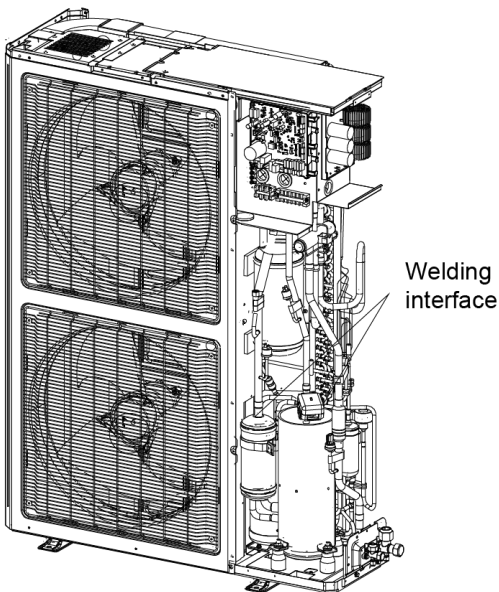
Disassembly of compressor		
NOTE: Before removing the compressor, make sure there is no refrigerant in the pipeline and power is cut off.		
Step	Picture	Work instruction
4. Remove the compressor from the chassis.		<ul style="list-style-type: none"> Take out the compressor and replace it. <p>NOTE: When replacing the compressor, avoid touching the nearby pipeline and components.</p>
5. Fix the new compressor back onto the chassis.		<ul style="list-style-type: none"> After replacing the compressor, tighten up the screws at the foot of compressor.
6. Connect the compressor suction port and exhaust port with the pipes.		<ul style="list-style-type: none"> Weld the compressor connection pipes and connect them to the compressor. <p>NOTE: When replacing the compressor, avoid touching the nearby pipeline and components.</p>

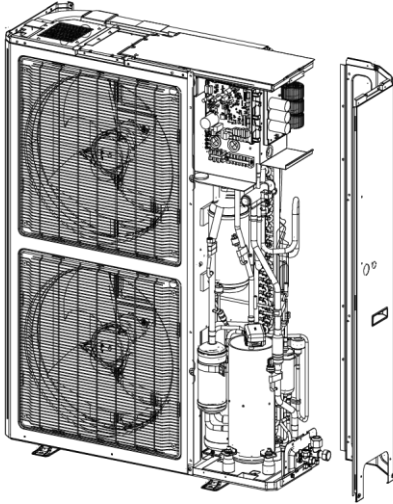
Disassembly of compressor		
NOTE: Before removing the compressor, make sure there is no refrigerant in the pipeline and power is cut off.		
Step	Picture	Work instruction
7. Connect the compressor wires.		<ul style="list-style-type: none"> ● Connect the compressor wires to the wire terminals on the top of compressor. <p>NOTE: When connecting the wires, be sure to match the colors with the corresponding wire terminals.</p>

Model: FLEXX60HP230V1AO

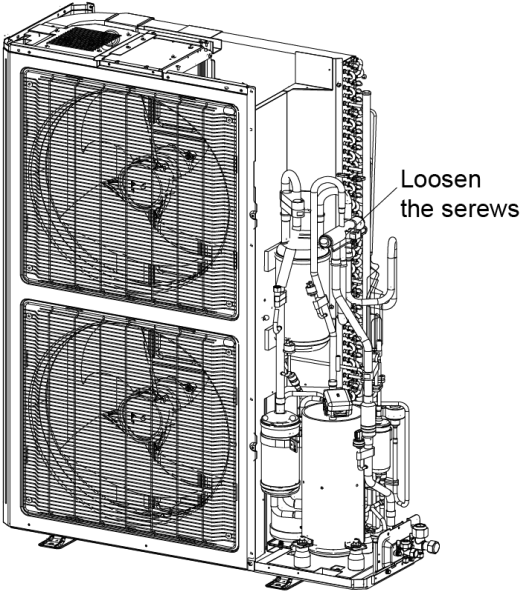
Removal of 4-way valve		
NOTE: Before removing the 4-way valve, make sure refrigerant is fully discharged from the unit and power is cut off.		
Step	Picture	Work instruction
1. Take off the coil of the 4-way valve.		<ul style="list-style-type: none"> ● Carefully unscrew the screws of electromagnetic coil with a screwdriver.

Removal of 4-way valve

NOTE: Before removing the 4-way valve, make sure refrigerant is fully discharged from the unit and power is cut off.

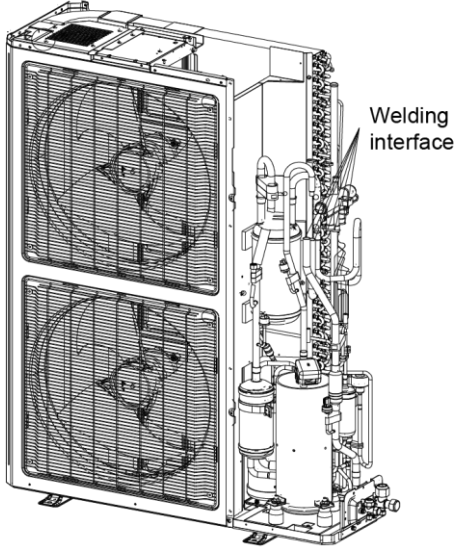
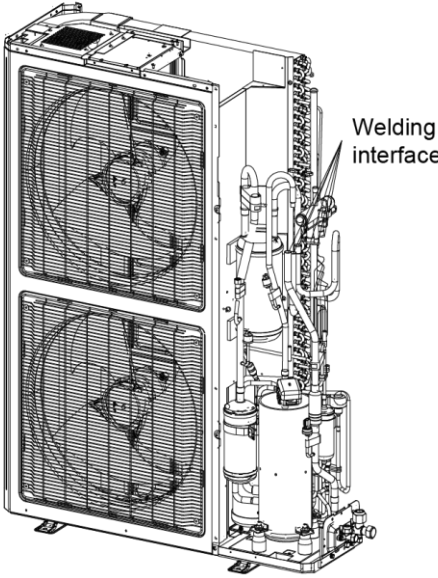
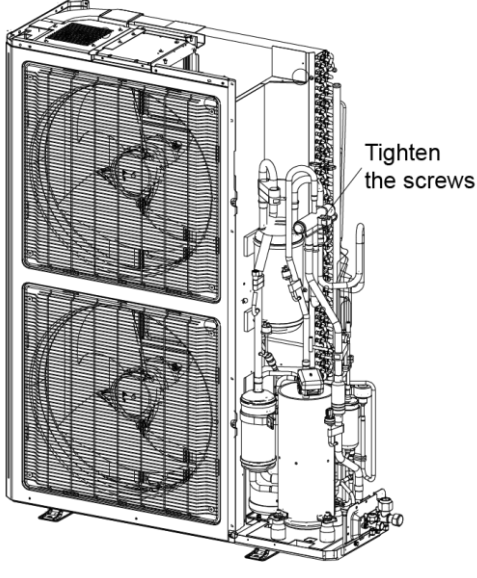
Step	Picture	Work instruction
<p>2. Break off the connection pipes from the 4-way valve.</p>		<ul style="list-style-type: none"> ● Use a soldering gun to loosen the 4 joints on the 4-way valve and then remove the connection pipes. <p>NOTE: When welding the pipes, the 4-way valve should be wrapped with wet cloth for cooling. Do not let the flame burn the other components.</p>
<p>3. Replace the 4-way valve and connect it to the connection pipes.</p>		<ul style="list-style-type: none"> ● Replace the 4-way valve and then use a soldering gun to weld the 4 joints of the 4-way valve. <p>Note: When welding the pipes, the 4-way valve should be wrapped with wet cloth for cooling. Do not let the flame burn the other components.</p>
<p>4. Install the coil of 4-way valve.</p>		<ul style="list-style-type: none"> ● Tighten the screws of the coil of 4-way valve with a screwdriver.

Model: FLEXX60HP230V1AO

Removal of fan and motor

NOTE: Before removing the fan, make sure power is cut off.

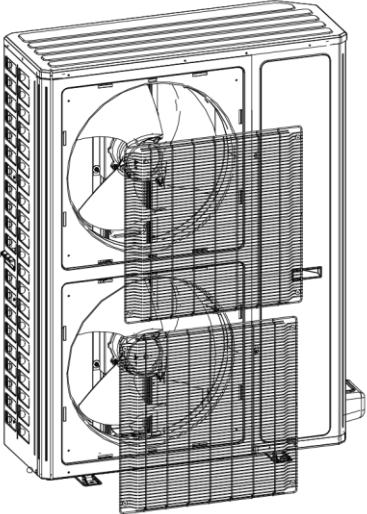
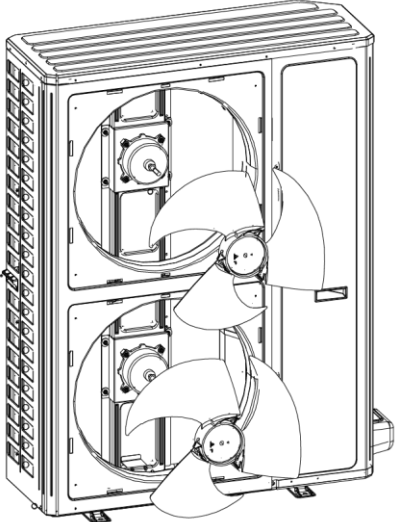
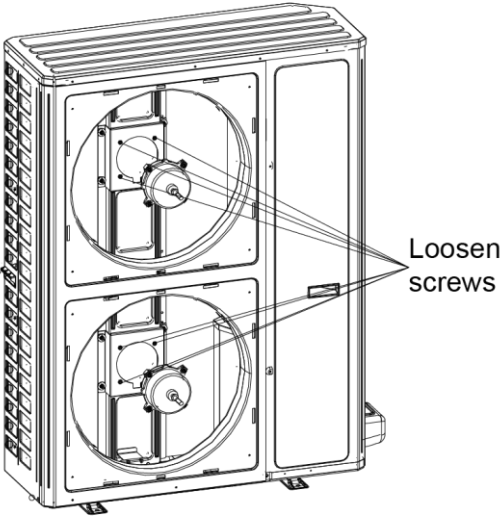
Step	Picture	Work instruction
1. Remove the grill.		<ul style="list-style-type: none"> ● Use a screwdriver to unscrew the two screws on the upper left and lower right corners.
2. Remove the fan.		<ul style="list-style-type: none"> ● Use a wrench to remove the specialized nut and gasket of the fan. <p>NOTE: Please keep the nut and gasket safe after removing them from the fan.</p>
3. Remove motor.		<ul style="list-style-type: none"> ● Use a screwdriver to unscrew the bolt of motor. <p>NOTE: Motor wire should be first removed from the electric box.</p>

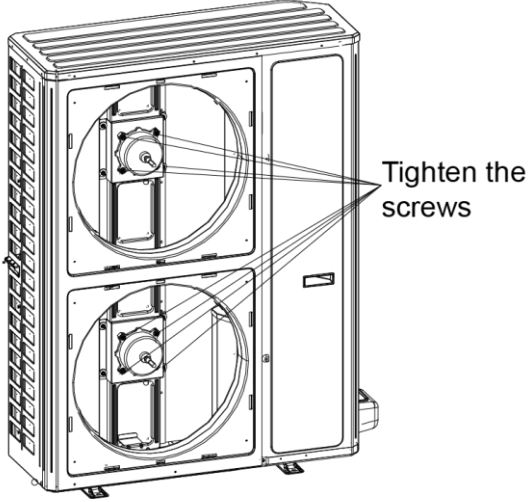
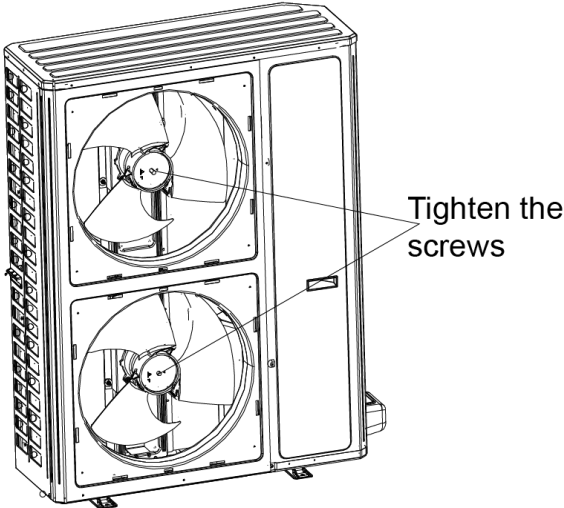
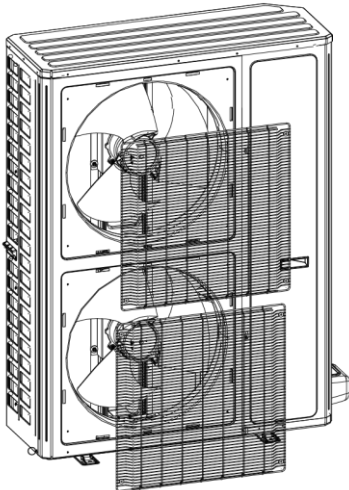
Removal of fan and motor		
NOTE: Before removing the fan, make sure power is cut off.		
Step	Picture	Work instruction
4. Install the motor.	 <p>Tighten the screws</p>	<ul style="list-style-type: none"> ● Replace with a new motor. Then tighten up the screw bolt.
5. Install the fan.	 <p>Tighten the screws</p>	<ul style="list-style-type: none"> ● Install the fan in place. Put on the gasket and use a wrench to secure the screw nut. <p>NOTE:After installing the fan, turn the fan by hand to see if it can run normally. If not, please check for the reason.</p>
6. Install the grill.		<ul style="list-style-type: none"> ● After replacing the motor, use a screwdriver to tighten up the screw bolt that secures the motor.

Model: FLEXX60HP230V1AO

Removal of gas liquid separator

NOTE: Before removing the gas liquid separator, make sure there is no refrigerant in the pipeline and power is cut off.

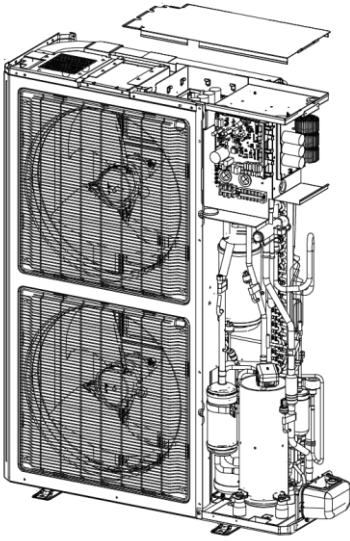
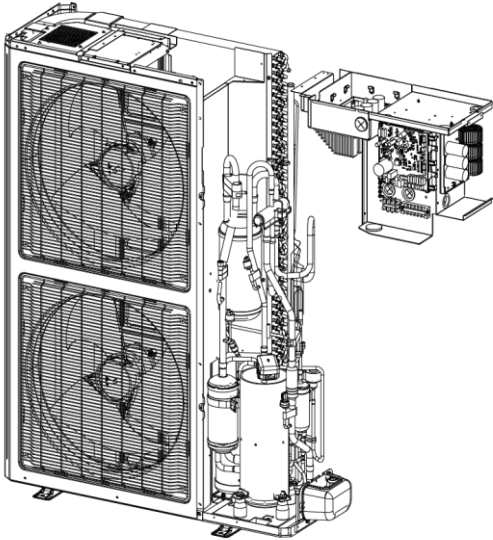
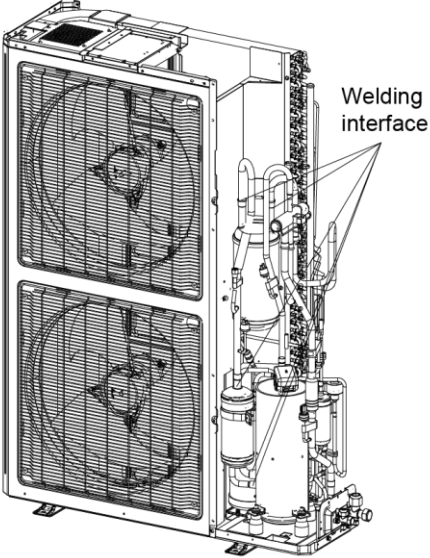
Step	Picture	Work instruction
<p>1. Loosen the wire clamp at the bottom of the electric box and the screws of electric box.</p>		<ul style="list-style-type: none"> ● Remove the upper, lower and front panels. ● Loosen the wire clamp at the bottom of the electric box. ● Unscrew the screws of electric box.
<p>2. Remove the electric box.</p>		<ul style="list-style-type: none"> ● The connection wires inside and outside the electric box should be removed. ● When removing the electric box, be careful to protect the components.
<p>3. Remove the compressor/gas liquid separator from the chassis.</p>		<ul style="list-style-type: none"> ● Take away the compressor/gas liquid separator and replace with a new one. <p>NOTE: When replacing the compressor/gas liquid separator, avoid touching the nearby pipeline and components.</p>

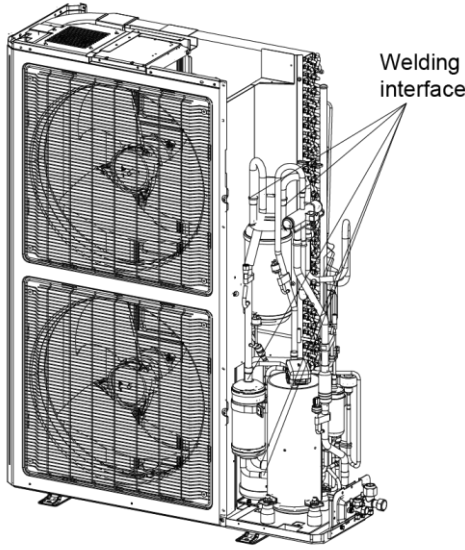
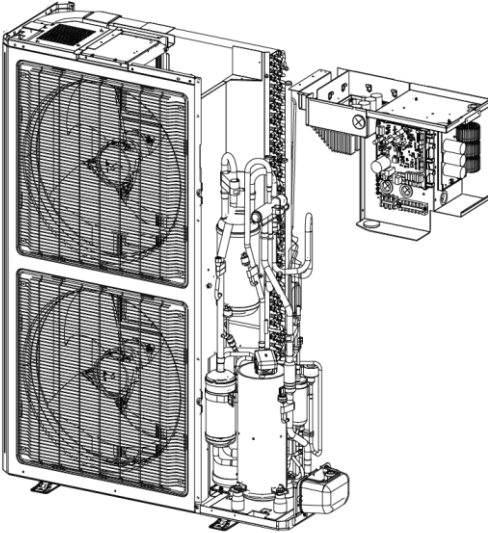
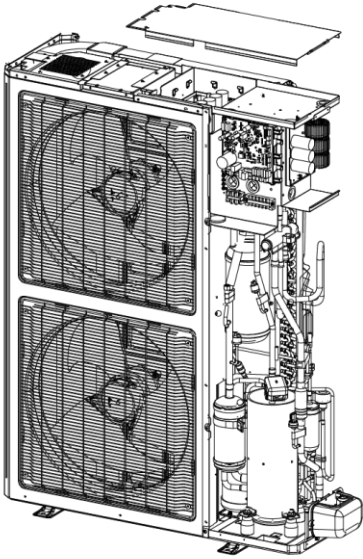
Removal of gas liquid separator		
NOTE: Before removing the gas liquid separator, make sure there is no refrigerant in the pipeline and power is cut off.		
Step	Picture	Work instruction
4. Install the new gas liquid separator		<ul style="list-style-type: none"> ● Install the gas liquid separator by referring to the positions of entering and leaving pipes. Weld the 2 welding interfaces. ● Nitrogen welding: the pressure of nitrogen is $0.5 \pm 0.1 \text{ kgf/cm}^2$ (relative pressure). NOTE: When welding the pipes, do not let the flame burn the other components. ● Tighten the screws of gas liquid separator.
5. Secure the electric box and arrange the wires as required.		<ul style="list-style-type: none"> ● Put the electric box back in place and tighten up the screws. ● Arrange the wires as original.
6. Check and open the upper and side panels.		<ul style="list-style-type: none"> ● Check whether each component and connection wire is well connected. ● If everything is OK, install the upper, left and right panels. Tighten up the screws.

Model: FLEXX60HP230V1AO

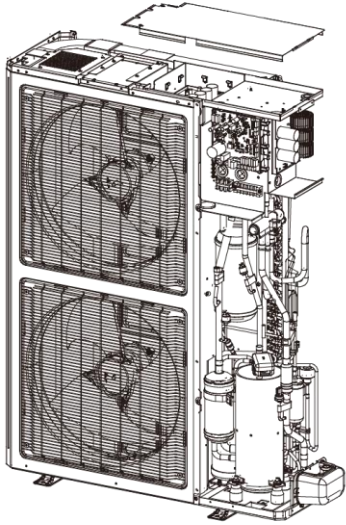
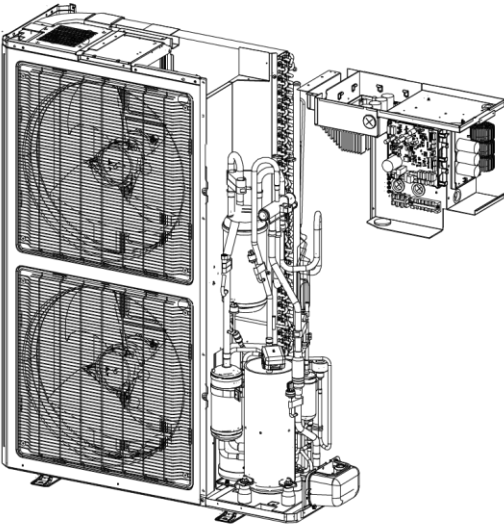
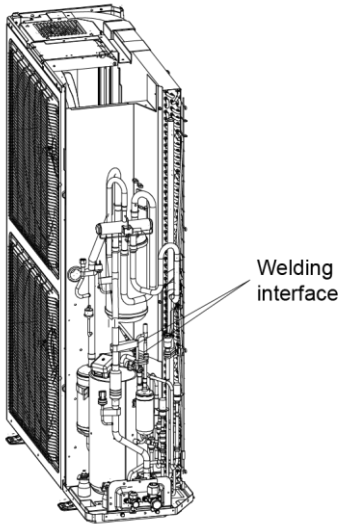
Removal of electronic expansion valve		
NOTE: Before removing the electronic expansion valve, make sure there is no refrigerant in the pipeline and power is cut off.		
Step	Picture	Work instruction
1. Loosen the wire clamp at the bottom of the electric box and the screws of electric box.		<ul style="list-style-type: none"> ● Remove the upper, lower and front panels. ● Loosen the wire clamp at the bottom of the electric box. ● Unscrew the screws of electric box.
2. Remove the electric box.		<ul style="list-style-type: none"> ● The connection wires inside and outside the electric box should be removed. ● When removing the electric box, be careful to protect the components.
3. Remove the electronic expansion valve.		<ul style="list-style-type: none"> ● Take off the coil of electronic expansion valve. ● Loosen the connection pipe of electronic expansion valve by welding. Then remove the connection pipe. <p>NOTE: When welding the pipe, do not let the flame bunt the other components.</p>

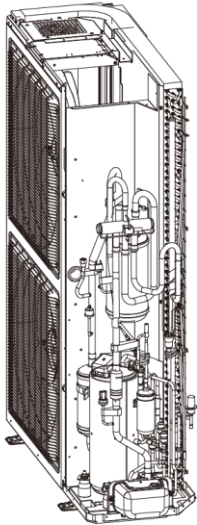
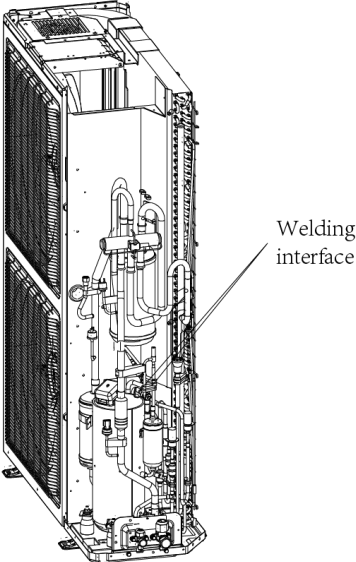
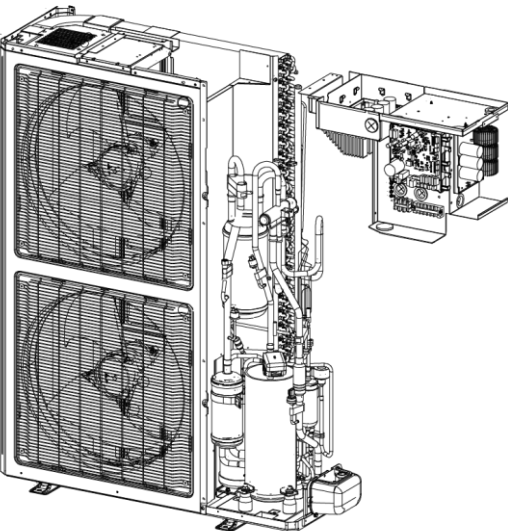
Removal of electronic expansion valve		
NOTE: Before removing the electronic expansion valve, make sure there is no refrigerant in the pipeline and power is cut off.		
Step	Picture	Work instruction
4. Take out the electronic expansion valve.		<ul style="list-style-type: none"> ● Take out the electronic expansion valve.
5. Install the new electronic expansion valve.		<ul style="list-style-type: none"> ● Weld the connection pipe of electronic expansion valve. ● When welding the electronic expansion valve, the valve should be wrapped with wet cloth. ● Nitrogen welding: the pressure of nitrogen is $0.5 \pm 0.1 \text{ kgf/cm}^2$ (relative pressure). ● NOTE: When welding the pipes, do not let the flame burn the other components. ● Install the coil of electronic expansion valve.
6. Secure the electric box and arrange the wires as required.		<ul style="list-style-type: none"> ● Put the electric box back in place and tighten up the screws. ● Arrange the wires as original.

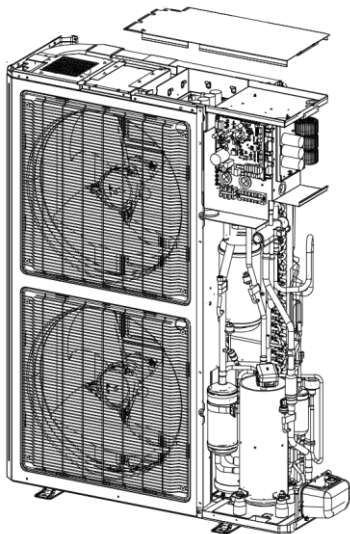
Removal of electronic expansion valve		
NOTE: Before removing the electronic expansion valve, make sure there is no refrigerant in the pipeline and power is cut off.		
Step	Picture	Work instruction
7. Check and open the upper and side panels.		<ul style="list-style-type: none"> ● Check whether each component and connection wire is well connected. ● If everything is OK, install the upper, left and right panels. Tighten up the screws.

4.5.2 Removal of IDU Major Components

4.5.2.1 Airhandler Unit

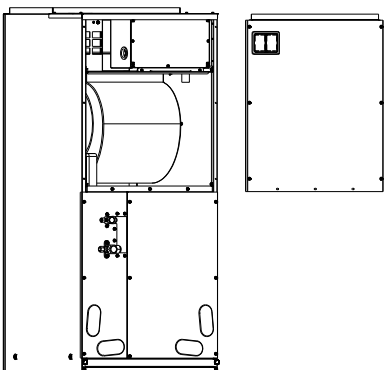
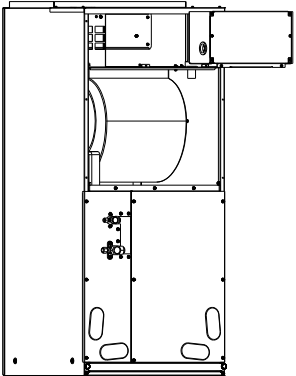
Disassembly and Assembly of the Electric Box		
Step	Picture	Work instruction
1. Remove the upper panel		<ul style="list-style-type: none"> ● Loosen screws around the upper panel with a screwdriver. ● Remove the upper panel away from the unit.
2. Remove the electric box.		<ul style="list-style-type: none"> ● Disconnect the power cord and control line from the wiring terminals, and then draw them out. ● Loosen screws around the electric box with a screwdriver. ● Remove the electric box from the unit.

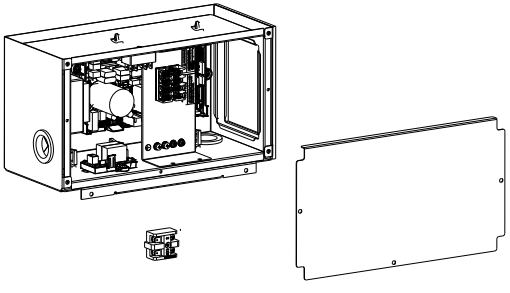
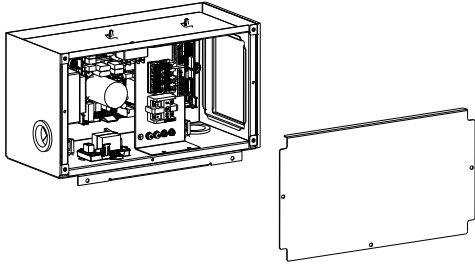
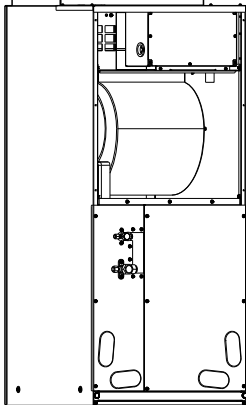
Disassembly and Assembly of the Electric Box		
Step	Picture	Work instruction
3. Remove the electric element.		<ul style="list-style-type: none"> ● Disconnect the electric element from the wiring terminal. ● Loosen screws around the electric element with a screwdriver. ● Remove the electric element from the electric box.
4. Mount the new electric element.		<ul style="list-style-type: none"> ● Place the electric element at the proper position. ● Tighten the screws around the electric element with a screwdriver. ● Wire the electric element to the wiring terminal.
5. Reinstall the electric box.		<ul style="list-style-type: none"> ● Place the electric box at the proper position. ● Tighten screws around the electric box with a screwdriver. ● Connect the power cord and control line properly. ● Reassemble the unit as before.

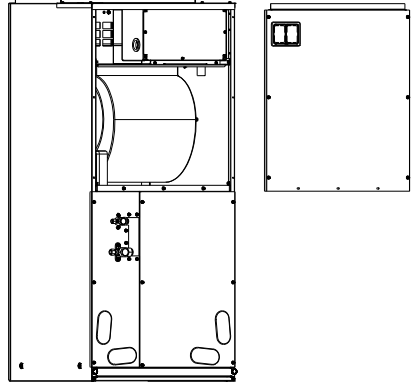
Disassembly and Assembly of the Fan Motor		
Step	Picture	Work instruction
1. Remove the upper panel.		<ul style="list-style-type: none"> ● Loosen screws round the upper panel with a screwdriver. ● Remove the upper panel from unit.

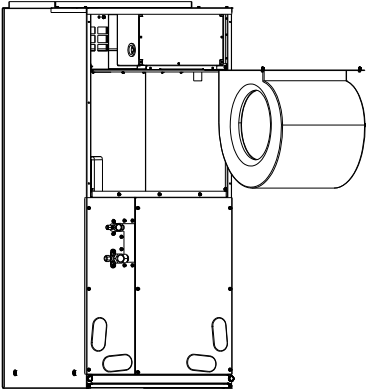
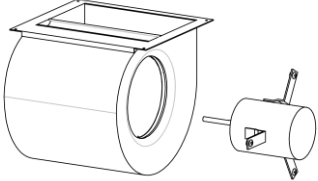
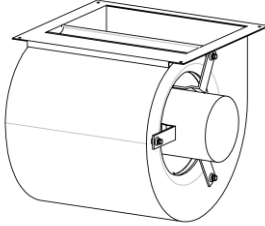
Disassembly and Assembly of the Fan Motor		
Step	Picture	Work instruction
2. Remove the fan.		<ul style="list-style-type: none"> • Disconnect the wires of the fan from the wiring terminal and draw them out. • Loosen screws located at the front of the fan with a screwdriver. • Remove the fan from the unit.
3. Remove the motor.		<ul style="list-style-type: none"> • Loosen screws fixing the motor and fan blades. • Loosen screw bolts fixing the bracket. • Remove the motor rightward from the fan.
4. Reinstall the fan.		<ul style="list-style-type: none"> • Place the motor at the proper position. • Tighten screws fixing the motor and fan blades. • Tighten screw bolts fixing the motor bracket. • After the installation, reassemble the unit as before.

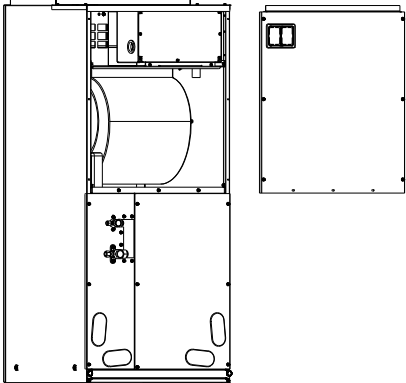
Disassembly and Assembly of the Evaporator and Drain Pan		
Step	Picture	Work instruction
1. Remove the upper panel.		<ul style="list-style-type: none"> • Loosen screws round the upper panel with a screwdriver. • Remove the upper panel from unit

Disassembly and Assembly of the Evaporator and Drain Pan

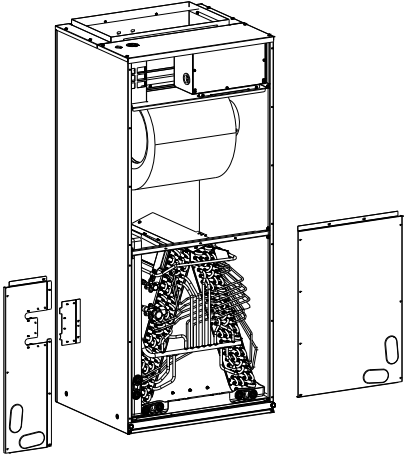
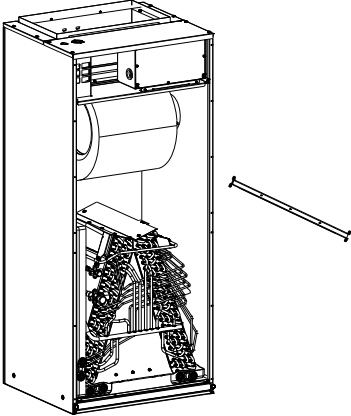
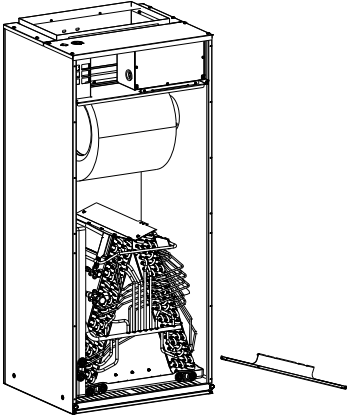
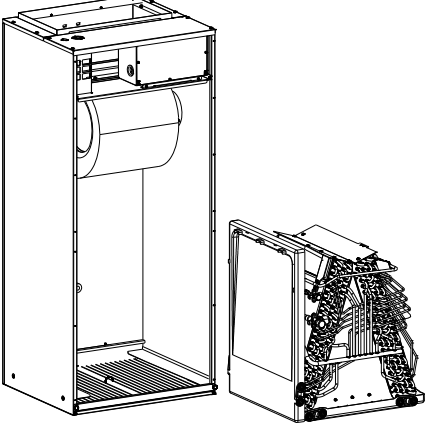
Step	Picture	Work instruction
<p>2. Remove the lower panel (1) and panel (2).</p>		<ul style="list-style-type: none"> ● Loosen screws round the lower panel with a screwdriver. ● Remove the lower panel from unit.
<p>3. Remove the enhanced frame if applicable.</p>		<ul style="list-style-type: none"> ● Remove the screws from enhanced frame. ● Disassemble the enhanced frame from the unit.
<p>4. Remove the mounting plate of the drain pan.</p>		<ul style="list-style-type: none"> ● Loosen screws at both side of the mounting plate with a screwdriver. ● Remove the mounting plate from the unit.
<p>5. Remove the primary drain pan.</p>		<ul style="list-style-type: none"> ● Remove the primary drain pan from the unit.

Disassembly and Assembly of the Evaporator and Drain Pan

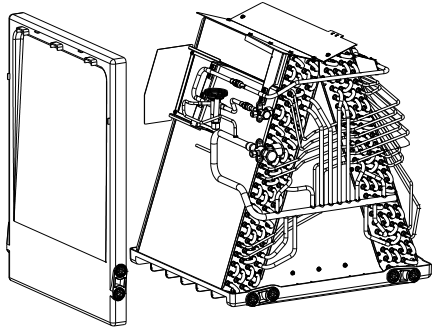
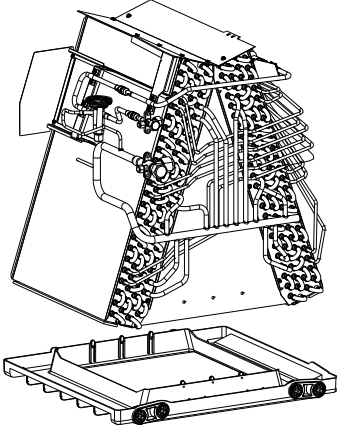
Step	Picture	Work instruction
6. Remove the secondary drain pan.		<ul style="list-style-type: none"> ● Remove the secondary drain pan from the unit.
7. Remove the evaporator.		<ul style="list-style-type: none"> ● Remove the evaporator away from the primary drain pan. ● Reassemble the unit as before.

Disassembly and Assembly of the Filter

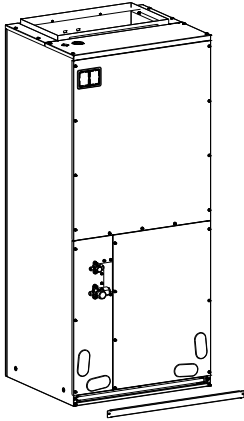
Step	Picture	Work instruction
1. Remove the mounting plate.		<ul style="list-style-type: none"> ● Loosen screws fixing the mounting plate with a screwdriver. ● Remove the mounting plate away from the unit.

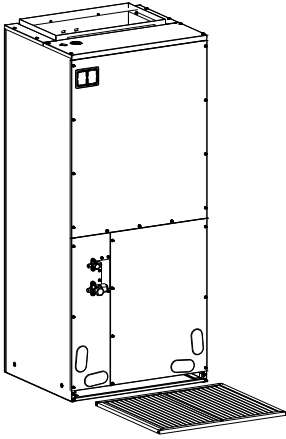
Disassembly and Assembly of the Filter		
Step	Picture	Work instruction
2. Remove the filter screen.		<ul style="list-style-type: none">● Remove the filter screen away from the unit.● After replacing the filter screen, reassemble the unit as before.

4.6 Explosive View and Lists of Parts

4.6.1 ODU Explosive View and Lists of Parts

FLEXX36HP230V1AO (Product code: CF090W1530)

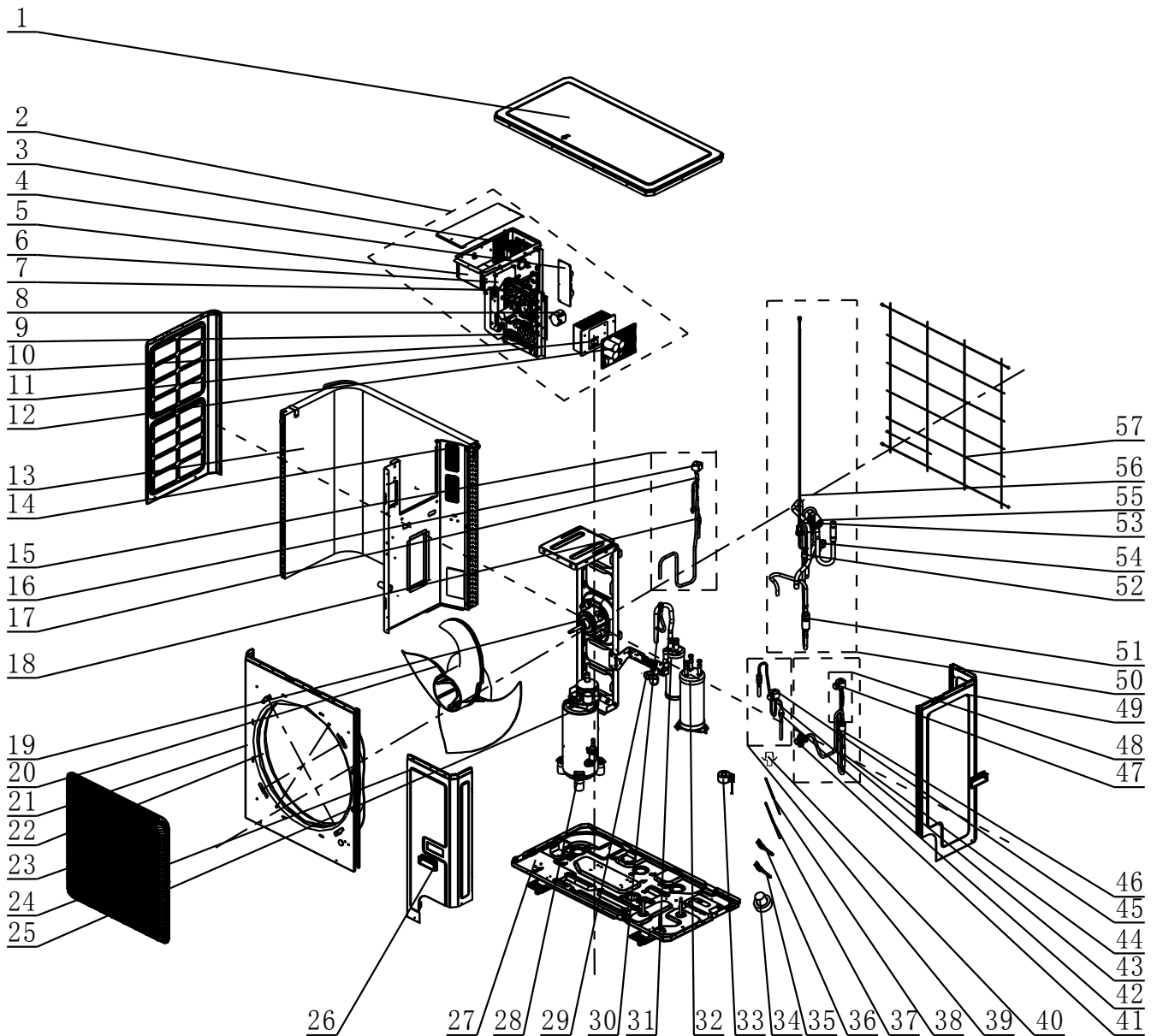

No.	Material name
1	Coping
2	Electric Box Assy
3	PFC Inductance
4	Filter Board
5	Reactor Sub-Assy
6	Power Switch
7	Main Board

No.	Material name
8	Inductance
9	Terminal Board
10	Terminal Board
11	Radiator
12	Main Board
13	Condenser Assy
14	Filter Sub-Assy
15	Electromagnetic Valve Sub-Assy
16	Magnet Coil (Electromagnetic Valve)
17	Electromagnetic Valve
18	Strainer
19	Brushless DC Motor
20	Axial Flow Fan
21	Cabinet
22	Diversion Circle
23	Front Grill
24	Front Side Plate
25	Compressor And Fittings
26	Handle
27	Chassis Assy
28	Foot
29	Cut Off Valve
30	Fusible Plug
31	Gas-liquid Separator
32	Accumulator
33	4 Way Valve Coil
34	Drainage Hole Cap
35	Temperature Sensor
36	Temperature Sensor
37	Electrical Heater(Compressor)
38	Electrical Heater (Chassis)
39	Electric Expansion Valve Sub-Assy
40	Drainage Joint
41	Cut-Off Valve 3/8(N)
42	Strainer
43	Electric Expand Valve Fitting
44	One Way Valve
45	Electronic Expansion Valve
46	Strainer
47	Electric Expand Valve Fitting
48	Electric Expansion Valve Sub-Assy
49	Rear Side Plate
50	4-Way Valve Assy
51	Silencer
52	Pressure Protect Switch

No.	Material name
53	Filter
54	Pressure Protect Switch
55	4-Way Valve
56	Pressure Sensor
57	Rear Grill

FLEXX60HP230V1AO (Product code: CF090W1820)

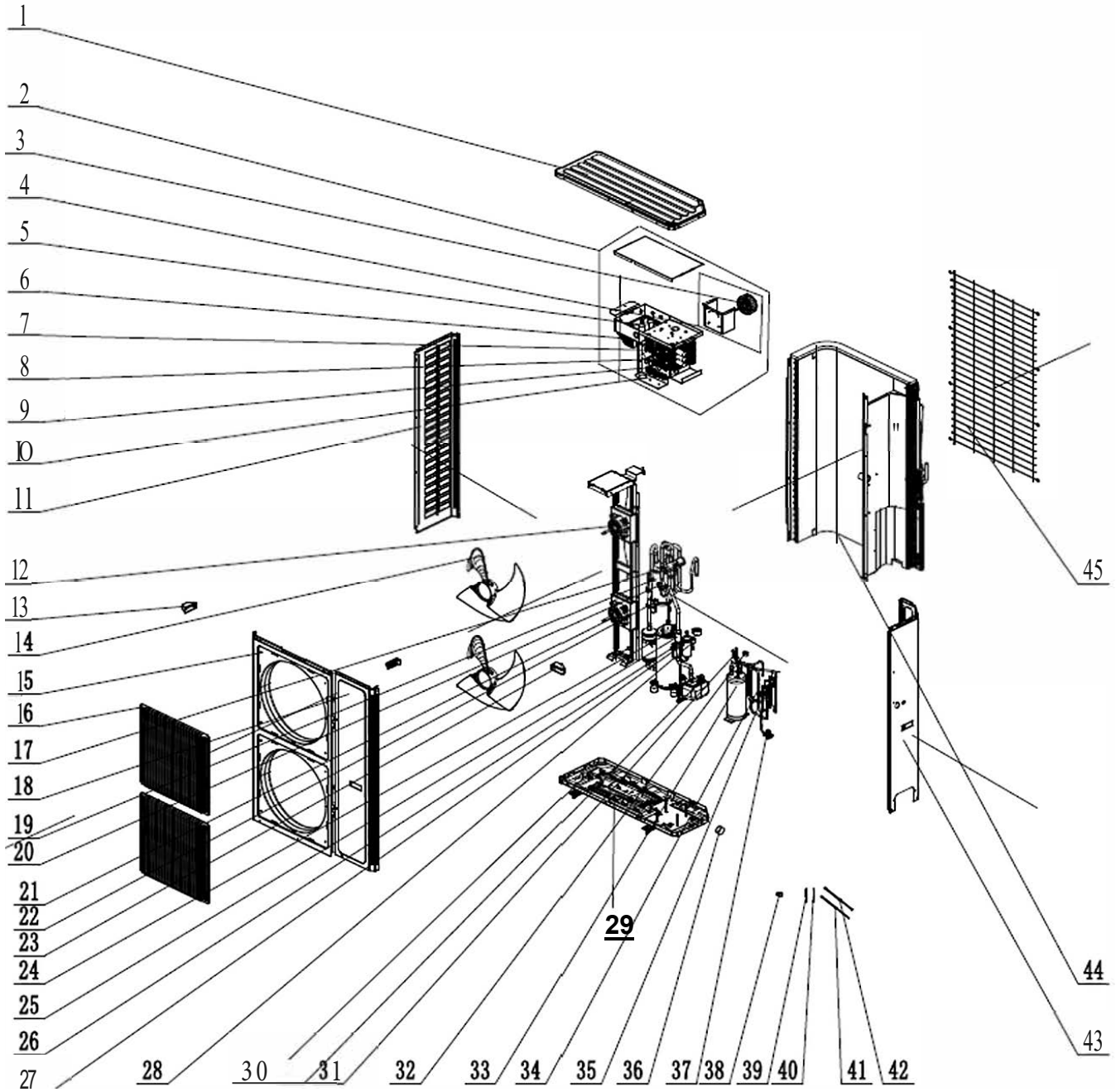

No.	Description	Part Number
1	Top Cover	01265356P03
2	Electric Box Assy	100002067316
3	Inductance	43120122
4	Inductance Box Sub-assy	017024060021
5	Drive Board	300078060066
6	Radiator	430034000032

No.	Description	Part Number
7	Main Board	300027060636
8	Filter board	300020060032
9	Terminal Board	422000000015
10	Terminal Board	4201025502
11	Left Side Plate	01315366P02
12	Fan Motor	1570280000403
13	Handle	2623305301
14	Axial Flow Fan	10335008
15	Cabinet	01515204P02
16	Front Grill	01600400000601
17	4-Way Valve Assy	030152060548
18	Front Side Plate	01315364P02
19	Gas-liquid Separator Sub-Assy	0722501801
20	Pressure Protect Switch	4602000603
21	Brushless DC Motor	1570280000410
22	Pressure Protect Switch	46020007
23	Handle	2623525309
24	Compressor and Fittings	009001000266
25	Filter	07216221
26	Pressure Sensor	43004400001503
27	Electric Expand Valve Fitting	4300034501
28	Electric Expand Valve Fitting	4300034502
29	Chassis Sub-assy	000191060080
30	Cut-off Valve	07130212
31	Electromagnetic Valve	43003091
32	Magnet Coil (electromagnetic valve)	4304000488
33	Accumulator	07424100031
34	One Way Valve	07133618
35	Electronic Expansion Valve	072009060004
36	Drainage hole Cap	06813401
37	Cut off Valve	07130209
38	4 Way Valve Coil	4300040094
39	Temperature Sensor	3900028025G
40	Temperature Sensor	3900007201
41	electrical heater	7651521216
42	Electrical Heater	7651000417
43	Rear Side Plate Sub-Assy	017051060121P
44	Condenser Assy	000100060341
45	Rear Grill	0157520501
Not Shown	Drainage Joint	Need Part #

4.6.2 IDU Explosive View and Lists of Parts

FLEXX36HP230V1AH (Product code: EM116N0890)

FLEXX60HP230V1AH (Product code: EH010N0031) 1

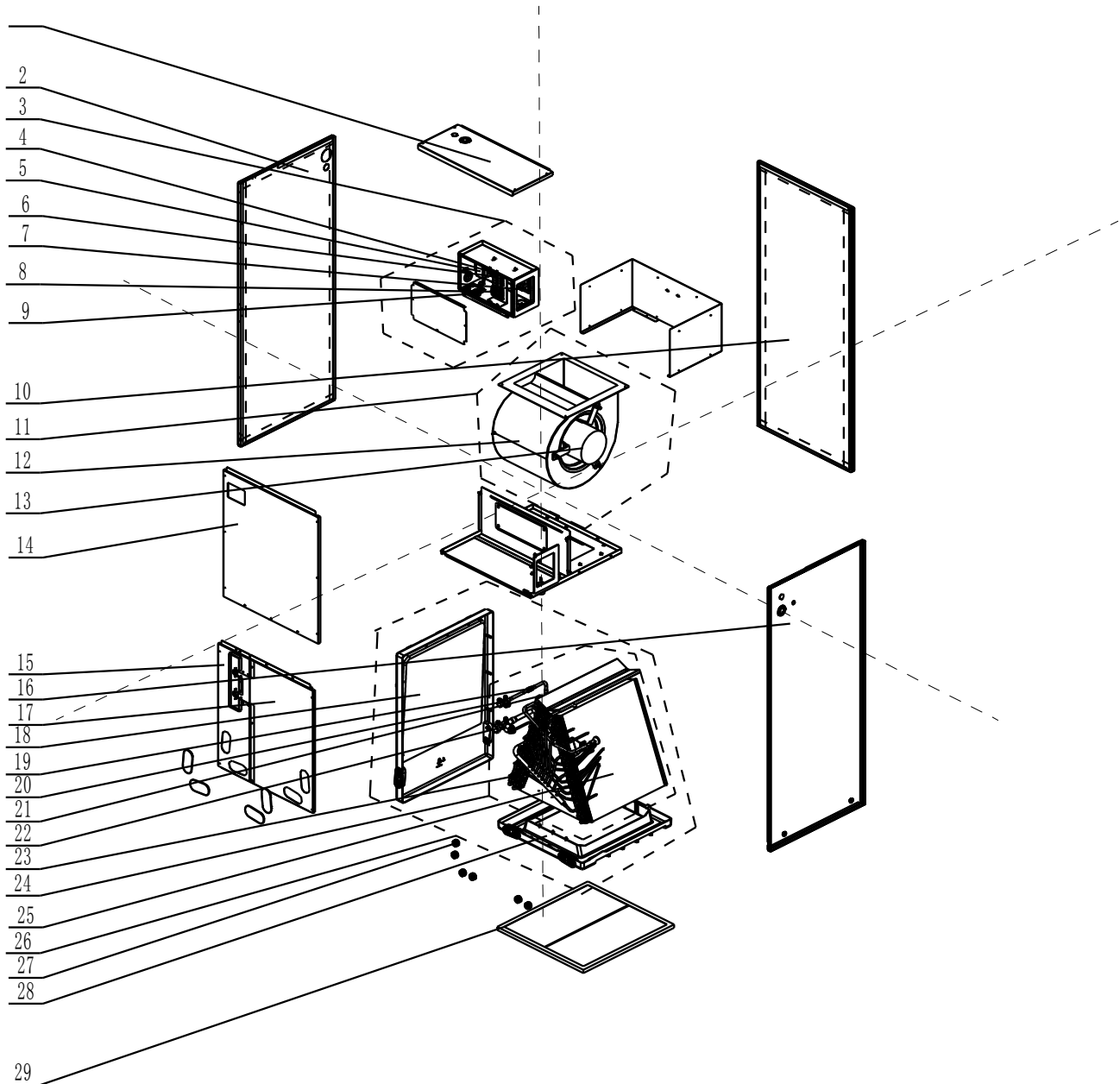

No.	Material name
1	Coping
2	Left Side Plate
3	Electric Box Assy
4	Terminal Board
5	Transformer
6	Terminal Board
7	Main Board
8	Terminal Board
9	Pinboard

No.	Material name
10	Rear Side Plate
11	Centrifugal Fan Assy
12	Motor For Centrifugal Fan
13	Brushless DC Motor
14	Top Cover Board Sub-Assy
15	Bottom Cover Plate Assy
16	Right Side Plate
17	Bottom Cover Plate Assy
18	Water Tray
19	Strainer
20	Cut-Off Valve 3/8(N)
21	Thermal Expansion Valve
22	Cut Off Valve
23	Evaporator Assy
24	Evaporator Assy
25	Evaporator Assy
26	Water Tray Assy
27	Choke Plug
28	Water Tray
29	Filter Sub-Assy

Appendices

1 Resistance/Temperature Lists of Temperature Sensors

1.1 Voltage List of 15 K Ω Temperature Sensors (including ODU temperature sensors)

Temperature (°C)	Resistance (k Ω)	Voltage (V)	Temperature (°C)	Resistance (k Ω)	Voltage (V)
-20	144	0.311	71	2.523	2.825
-19	138.1	0.323	72	2.439	2.838
-18	128.6	0.345	73	2.358	2.852
-17	121.6	0.362	74	2.28	2.865
-16	115	0.381	75	2.205	2.877
-15	108.7	0.4	76	2.133	2.889
-14	102.9	0.42	77	2.064	2.901
-13	97.4	0.44	78	1.997	2.912
-12	92.22	0.462	79	1.933	2.923
-11	87.35	0.484	80	1.871	2.934
-10	82.75	0.506	81	1.811	2.945
-9	78.43	0.53	82	1.754	2.955
-8	74.35	0.554	83	1.699	2.964
-7	70.5	0.579	84	1.645	2.974
-6	66.88	0.605	85	1.594	2.983
-5	63.46	0.631	86	1.544	2.992
-4	60.23	0.658	87	1.497	3.001
-3	57.18	0.686	88	1.451	3.009
-2	54.31	0.714	89	1.408	3.017
-1	51.59	0.743	90	1.363	3.025
0	49.02	0.773	91	1.322	3.033
1	46.8	0.801	92	1.282	3.04
2	44.31	0.835	93	1.244	3.047
3	42.14	0.866	94	1.207	3.054
4	40.09	0.899	95	1.171	3.061
5	38.15	0.931	96	1.136	3.068
6	36.32	0.965	97	1.103	3.074
7	34.58	0.998	98	1.071	3.08
8	32.94	1.033	99	1.039	3.086
9	31.38	1.067	100	1.009	3.092
10	29.9	1.102	101	0.98	3.098
11	28.51	1.138	102	0.952	3.103
12	27.18	1.174	103	0.925	3.108
13	25.92	1.21	104	0.898	3.114
14	24.73	1.246	105	0.873	3.119

Temperature (°C)	Resistance (kΩ)	Voltage (V)	Temperature (°C)	Resistance (kΩ)	Voltage (V)
15	23.6	1.282	106	0.848	3.123
16	22.53	1.319	107	0.825	3.128
17	21.51	1.356	108	0.802	3.133
18	20.54	1.393	109	0.779	3.137
19	19.63	1.429	110	0.758	3.141
20	18.75	1.467	111	0.737	3.145
21	17.93	1.503	112	0.717	3.15
22	17.14	1.54	113	0.697	3.153
23	16.39	1.577	114	0.678	3.157
24	15.68	1.613	115	0.66	3.161
25	15	1.65	116	0.642	3.165
26	14.36	1.686	117	0.625	3.168
27	13.74	1.722	118	0.608	3.171
28	13.16	1.758	119	0.592	3.175
29	12.6	1.793	120	0.577	3.178
30	12.07	1.829	121	0.561	3.181
31	11.57	1.863	122	0.547	3.184
32	11.09	1.897	123	0.532	3.187
33	10.63	1.931	124	0.519	3.19
34	10.2	1.964	125	0.505	3.192
35	9.779	1.998	126	0.492	3.195
36	9.382	2.03	127	0.48	3.198
37	9.003	2.062	128	0.467	3.2
38	8.642	2.094	129	0.456	3.203
39	5.997	2.125	130	0.444	3.205
41	7.653	2.185	131	0.433	3.207
42	7.352	2.215	132	0.422	3.21
43	7.065	2.243	133	0.412	3.212
44	6.791	2.272	134	0.401	3.214
45	6.529	2.299	135	0.391	3.216
46	6.278	2.326	136	0.382	3.218
47	6.038	2.353	137	0.372	3.22
48	5.809	2.379	138	0.363	3.222
49	5.589	2.404	139	0.355	3.224
50	5.379	2.429	140	0.346	3.226
51	5.179	2.453	141	0.338	3.227
52	4.986	2.477	142	0.33	3.229
53	4.802	2.5	143	0.322	3.231
54	4.625	2.522	144	0.314	3.232
55	4.456	2.544	145	0.307	3.234
56	4.294	2.566	146	0.299	3.235
57	4.139	2.586	147	0.292	3.237
58	3.99	2.607	148	0.286	3.238
59	3.848	2.626	149	0.279	3.24
60	3.711	2.646	150	0.273	3.241

Temperature (°C)	Resistance (kΩ)	Voltage (V)	Temperature (°C)	Resistance (kΩ)	Voltage (V)
61	3.579	2.664	151	0.266	3.242
62	3.454	2.682	152	0.261	3.244
63	3.333	2.7	153	0.254	3.245
64	3.217	2.717	154	0.248	3.246
65	3.105	2.734	155	0.243	3.247
66	2.998	2.75	156	0.237	3.249
67	2.898	2.766	157	0.232	3.25
68	2.797	2.781	158	0.227	3.251
69	2.702	2.796	159	0.222	3.252
70	2.611	2.811	160	0.217	3.253

1.2 Voltage List of 20 KΩ Pipeline Temperature Sensors (including temperature sensors for defroster, IDU and ODU pipes)

Temperature (°C)	Resistance (kΩ)	Voltage (V)	Temperature (°C)	Resistance (kΩ)	Voltage (V)
-30	361.8	0.173	66	3.998	2.75
-29	339.8	0.183	67	3.861	2.766
-28	319.2	0.195	68	3.729	2.781
-27	300	0.206	69	3.603	2.796
-26	282.2	0.218	70	3.481	2.811
-25	265.5	0.231	71	3.364	2.825
-24	249.9	0.245	72	3.252	2.838
-23	235.3	0.259	73	3.144	2.852
-22	221.6	0.273	74	3.04	2.865
-21	208.9	0.288	75	2.94	2.877
-20	196.9	0.304	76	2.844	2.889
-19	181.4	0.328	77	2.752	2.901
-18	171.4	0.345	78	2.663	2.912
-17	162.1	0.362	79	2.577	2.923
-16	153.3	0.381	80	2.495	2.934
-15	145	0.4	81	2.415	2.944
-14	137.2	0.42	82	2.339	2.954
-13	129.9	0.44	83	2.265	2.964
-12	123	0.462	84	2.194	2.974
-11	116.5	0.484	85	2.125	2.983
-10	110.3	0.507	86	2.059	2.992
-9	104.6	0.53	87	1.996	3.001
-8	99.13	0.554	88	1.934	3.009
-7	94	0.579	89	1.875	3.017
-6	89.17	0.605	90	1.818	3.025
-5	84.61	0.631	91	1.763	3.033
-4	80.31	0.658	92	1.71	3.04
-3	76.24	0.686	93	1.658	3.047
-2	72.41	0.714	94	1.609	3.054

Temperature (°C)	Resistance (kΩ)	Voltage (V)	Temperature (°C)	Resistance (kΩ)	Voltage (V)
-1	68.79	0.743	95	1.561	3.061
0	65.37	0.773	96	1.515	3.068
1	62.13	0.804	97	1.47	3.074
2	59.08	0.835	98	1.427	3.08
3	56.19	0.866	99	1.386	3.086
4	53.46	0.898	100	1.346	3.092
5	50.87	0.931	101	1.307	3.098
6	48.42	0.965	102	1.269	3.103
7	46.11	0.998	103	1.233	3.108
8	43.92	1.033	104	1.198	3.114
9	41.84	1.067	105	1.164	3.119
10	39.87	1.102	106	1.131	3.123
11	38.01	1.138	107	1.099	3.128
12	36.24	1.174	108	1.069	3.133
13	34.57	1.209	109	1.039	3.137
14	32.98	1.246	110	1.01	3.141
15	31.47	1.282	111	0.9825	3.145
16	30.04	1.319	112	0.9556	3.15
17	28.68	1.356	113	0.9295	3.153
18	27.39	1.393	114	0.9043	3.157
19	26.17	1.429	115	0.8799	3.161
20	25.01	1.466	116	0.8562	3.165
21	23.9	1.503	117	0.8333	3.168
22	22.85	1.54	118	0.8111	3.171
23	21.85	1.577	119	0.7895	3.175
24	20.9	1.614	120	0.7687	3.178
25	20	1.65	121	0.7485	3.181
26	19.14	1.686	122	0.7289	3.184
27	18.32	1.722	123	0.7099	3.187
28	17.55	1.758	124	0.6915	3.19
29	16.8	1.793	125	0.6736	3.192
30	16.1	1.828	126	0.6563	3.195
31	15.43	1.863	127	0.6395	3.198
32	14.79	1.897	128	0.6232	3.2
33	14.18	1.931	129	0.6074	3.203
34	13.59	1.965	130	0.5921	3.205
35	13.04	1.998	131	0.5772	3.207
36	12.51	2.03	132	0.5627	3.21
37	12	2.063	133	0.5487	3.212
38	11.52	2.094	134	0.5351	3.214
39	11.06	2.125	135	0.5219	3.216
40	10.62	2.155	136	0.509	3.218
41	10.2	2.185	137	0.4966	3.22
42	9.803	2.215	138	0.4845	3.222

Temperature (°C)	Resistance (kΩ)	Voltage (V)	Temperature (°C)	Resistance (kΩ)	Voltage (V)
43	9.42	2.243	139	0.4727	3.224
44	9.054	2.272	140	0.4613	3.226
45	8.705	2.299	141	0.4502	3.227
46	8.37	2.326	142	0.4394	3.229
47	8.051	2.353	143	0.4289	3.231
48	7.745	2.379	144	0.4187	3.232
49	7.453	2.404	145	0.4088	3.234
50	7.173	2.429	146	0.3992	3.235
51	6.905	2.453	147	0.3899	3.237
52	6.648	2.477	148	0.3808	3.238
53	6.403	2.5	149	0.3719	3.24
54	6.167	2.522	150	0.3633	3.241
55	5.942	2.544	151	0.3549	3.242
56	5.726	2.565	152	0.3468	3.244
57	5.519	2.586	153	0.3389	3.245
58	5.32	2.607	154	0.3312	3.246
59	5.13	2.626	155	0.3237	3.247
60	4.948	2.646	156	0.3164	3.249
61	4.773	2.664	157	0.3093	3.25
62	4.605	2.682	158	0.3024	3.251
63	4.443	2.7	159	0.2956	3.252
64	4.289	2.717	160	0.2891	3.253
65	4.14	2.734			

1.3 Voltage List of 50 KΩ Discharge Temperature Sensors (including discharge air temperature sensor)

Temperature (°C)	Resistance (kΩ)	Voltage (V)	Temperature (°C)	Resistance (kΩ)	Voltage (V)
-30	911.56	0.036	61	11.736	1.518
-29	853.66	0.038	62	11.322	1.548
-28	799.98	0.041	63	10.925	1.577
-27	750.18	0.043	64	10.544	1.606
-26	703.92	0.046	65	10.178	1.635
-25	660.93	0.049	66	9.8269	1.664
-24	620.94	0.052	67	9.4896	1.693
-23	583.72	0.056	68	9.1655	1.722
-22	549.04	0.059	69	8.9542	1.741
-21	516.71	0.063	70	8.5551	1.778
-20	486.55	0.066	71	5.9676	1.806
-19	458.4	0.07	72	7.9913	1.834
-18	432.1	0.075	73	7.7257	1.862
-17	407.51	0.079	74	7.4702	1.889
-16	384.51	0.084	75	7.2245	1.916

Temperature (°C)	Resistance (kΩ)	Voltage (V)	Temperature (°C)	Resistance (kΩ)	Voltage (V)
-15	362.99	0.088	76	6.9882	1.943
-14	342.83	0.094	77	6.7608	1.969
-13	323.94	0.099	78	6.542	1.995
-12	306.23	0.104	79	6.3315	2.021
-11	289.61	0.11	80	6.1288	2.046
-10	274.02	0.116	81	5.9336	2.071
-9	259.37	0.123	82	5.7457	2.096
-8	245.61	0.129	83	5.5647	2.12
-7	232.67	0.136	84	5.3903	2.144
-6	220.5	0.143	85	5.2223	2.168
-5	209.05	0.151	86	5.0605	2.191
-4	195.97	0.158	87	4.9044	2.214
-3	188.12	0.167	88	4.7541	2.237
-2	178.65	0.175	89	4.6091	2.259
-1	169.68	0.184	90	4.4693	2.281
0	161.02	0.193	91	4.3345	2.302
1	153	0.202	92	4.2044	2.323
2	145.42	0.212	93	4.0789	2.344
3	135.96	0.223	94	3.9579	2.364
4	131.5	0.233	95	3.841	2.384
5	126.17	0.242	96	3.7283	2.404
6	119.08	0.256	97	3.6194	2.423
7	113.37	0.267	98	3.5143	2.442
8	107.96	0.28	99	3.4128	2.46
9	102.85	0.292	100	3.3147	2.478
10	98.006	0.306	101	3.22	2.496
11	93.42	0.319	102	3.1285	2.514
12	89.075	0.333	103	3.0401	2.531
13	84.956	0.348	104	2.9547	2.547
14	81.052	0.362	105	2.8721	2.564
15	77.349	0.378	106	2.7922	2.58
16	73.896	0.393	107	2.715	2.595
17	70.503	0.41	108	2.6404	2.611
18	67.338	0.427	109	2.5682	2.626
19	64.333	0.444	110	2.4983	2.64
20	61.478	0.462	111	2.4308	2.655
21	58.766	0.48	112	2.3654	2.669
22	56.189	0.499	113	2.3021	2.682
23	53.738	0.518	114	2.2409	2.696
24	51.408	0.537	115	2.1816	2.709
25	49.191	0.558	116	2.1242	2.722
26	47.082	0.578	117	2.0686	2.734
27	45.074	0.599	118	2.0148	2.747
28	43.163	0.621	119	1.9626	2.759

Temperature (°C)	Resistance (kΩ)	Voltage (V)	Temperature (°C)	Resistance (kΩ)	Voltage (V)
29	41.313	0.643	120	1.9123	2.77
30	39.61	0.665	121	1.8652	2.781
31	37.958	0.688	122	1.8158	2.793
32	36.384	0.711	123	1.7698	2.804
33	34.883	0.735	124	1.7253	2.814
34	33.453	0.759	125	1.6821	2.825
35	32.088	0.784	126	1.6402	2.835
36	30.787	0.809	127	1.5996	2.845
37	29.544	0.835	128	1.5602	2.855
38	28.359	0.86	129	1.522	2.864
39	27.227	0.886	130	1.485	2.873
40	26.147	0.913	131	1.449	2.882
41	25.114	0.94	132	1.4141	2.891
42	24.128	0.967	133	1.3803	2.9
43	23.186	0.994	134	1.3474	2.908
44	22.286	1.022	135	1.3155	2.916
45	21.425	1.05	136	1.2846	2.924
46	20.601	1.078	137	1.2545	2.932
47	19.814	1.107	138	1.2233	2.94
48	19.061	1.136	139	1.1969	2.947
49	18.34	1.164	140	1.1694	2.955
50	17.651	1.193	141	1.1476	2.96
51	16.99	1.223	142	1.1166	2.969
52	16.358	1.252	143	1.0913	2.975
53	15.753	1.281	144	1.0667	2.982
54	15.173	1.311	145	1.0429	2.988
55	14.618	1.34	146	1.0197	2.995
56	14.085	1.37	147	0.9971	3.001
57	13.575	1.4	148	0.9752	3.007
58	13.086	1.429	149	0.9538	3.013
59	12.617	1.459	150	0.9331	3.018
60	12.368	1.475	-	-	-

2 Temperature/Pressure List of Refrigerant

R410A							
Temperature	Pressure		Temperature	Pressure		Temperature	Pressure
°C	kPa		°C	kPa		°C	kPa
-30	275		0	803		30	1880
-29	286		1	823		31	1910
-28	298		2	851		32	1960
-27	311		3	879		33	2030
-26	324		4	903		34	2080
-25	334		5	937		35	2130
-24	348		6	962		36	2180
-23	363		7	994		37	2240
-22	375		8	1020		38	2290
-21	391		9	1050		39	2350
-20	404		10	1090		40	2410
-19	424		11	1110		41	2460
-18	435		12	1150		42	2510
-17	453		13	1180		43	2580
-16	468		14	1220		44	2650
-15	483		15	1250		45	2710
-14	504		16	1280		46	2770
-13	520		17	1320		47	2840
-12	538		18	1350		48	2910
-11	556		19	1400		49	2980
-10	579		20	1440		50	3050
-9	598		21	1470		51	3100
-8	618		22	1520		52	3180
-7	639		23	1560		53	3250
-6	660		24	1600		54	3320
-5	682		25	1640		55	3400
-4	705		26	1680		56	3480
-3	728		27	1730		57	3540
-2	752		28	1780		58	3630
-1	777		29	1820		59	3720

3 Operation Tools

The following tools will be used: 1) Liquid-level gauge; 2) Screwdriver; 3) Electric driven rotary hammer; 4) Drill; 5) Pipe expander; 6) Torque wrench; 7) Open-end wrench; 8) Pipe cutter; 9) Leak detector; 10) Vacuum pump; 11) Pressure gauge; 12) Universal meter; 13) Hexagon wrench; 14) Tapeline.



U.S. CONTACT INFORMATION TRADEWINDS, LLC

E-mail: info@twclimate.com

Contractor Support: 888-850-7928 | Mon-Fri 8 AM - 5 PM EDT

G R E E C O M F O R T . C O M